

NEO3LINE_FRAME_17_C_30_32_1N
 NEO3LINE_FRAME_17_C_30_64_2N

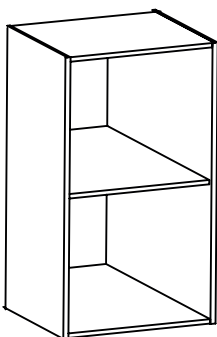

NEO3LINE_FRAME_35_C_30_32_1N
 NEO3LINE_FRAME_35_C_30_64_2N
 NEO3LINE_FRAME_48_C_30_32_1N
 NEO3LINE_FRAME_48_C_30_64_2N



FR Notice de Montage -
Utilisation - Entretien

ES Instrucciones de Montaje,
Utilización y Mantenimiento

PT Instruções de Montagem,
Utilização e Manutenção

IT Istruzioni per il Montaggio,
l'Uso e la Manutenzione

EL Εγχειρίδιο συναρμολόγησης,
χρήσης και συντήρησης

PL Instrukcja Montażu,
Użytkowania i Konserwacji

RO Manual asamblare,
utilizare și întreținere

EN Assembly - Use -
Maintenance Manual

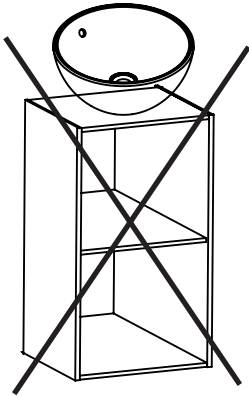
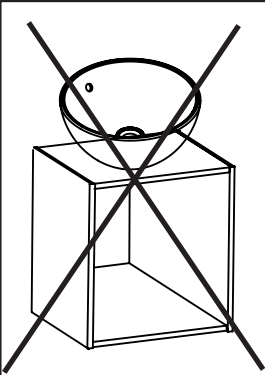

NEO3LINE_FRAME_17_C_30_32_1N
NEO3LINE_FRAME_17_C_30_64_2N

NEO3LINE_FRAME_35_C_30_32_1N
NEO3LINE_FRAME_35_C_30_64_2N

NEO3LINE_FRAME_48_C_30_32_1N
NEO3LINE_FRAME_48_C_30_64_2N

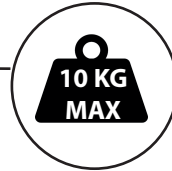
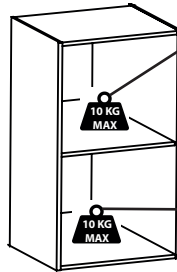
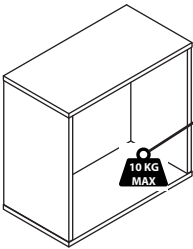

NEO3LINE_FRAME_35_C_30_32_1N
NEO3LINE_FRAME_35_C_30_64_2N



350x320

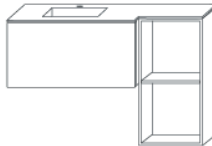

350x640

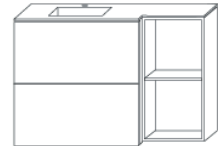

350x640



NEO3LINE_FRAME_48_C_30_32_1N
NEO3LINE_FRAME_48_C_30_64_2N



Max 60 kg

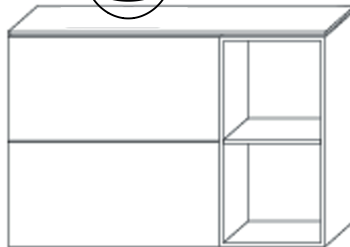

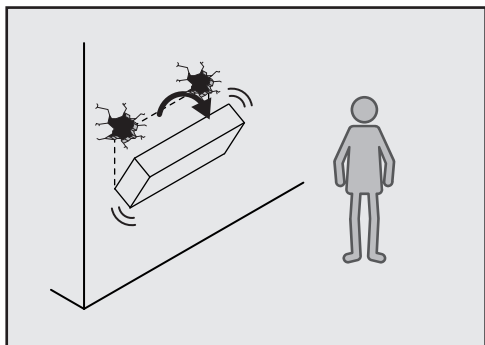

FR

AVERTISSEMENT:

Pour éviter tout risque de basculement, ce meuble/cet objet doit être solidement fixé au mur. Vérifier la pertinence et la solidité du mur afin de s'assurer que le mur puisse supporter la charge du meuble/de l'objet et résister aux forces générées au niveau des fixations. Un montage mal effectué peut provoquer la chute du meuble/de l'objet et des blessures graves sur les personnes. En cas de doute concernant l'installation, demandez conseil à un vendeur spécialisé ou contactez un professionnel.

- * Utiliser des vis, rondelles et chevilles adaptées au type de matériau de votre mur. Celles-ci ne sont pas incluses. Pour obtenir des conseils sur les vis et ferrures adaptées à votre mur, adressez-vous à un vendeur spécialisé.

ES

ADVERTENCIA:

Para evitar cualquier riesgo de que se vuelque, el mueble u objeto debe anclarse firmemente a la pared. Compruebe la adecuación y la solidez de la pared para asegurarse de que puede soportar el peso del mueble u objeto y resistir las fuerzas que se produzcan en las fijaciones. Un montaje inadecuado puede causar la caída del mueble u objeto y que se produzcan daños corporales. En caso de duda en relación a la instalación, pregunte a un vendedor especializado o recurra a un profesional.

- * Utilice tornillos, arandelas y tacos adecuados para el material de la pared. El producto no incluye la tornillería ni los tacos de sujeción. Para saber cuáles son los elementos de fijación más adecuados para su pared, pregunte a un vendedor especializado.

PT

AVISO:

Para evitar qualquer risco de basculamento, este móvel/objeto deve ser fixo à parede de forma segura. Verifique a adequabilidade e solidez da parede para se certificar de que pode suportar a carga do móvel/objeto e resistir às forças aplicadas ao nível das fixações. Uma montagem mal feita pode originar a queda do móvel/objeto e provocar danos pessoais graves. Em caso de dúvida em relação à instalação, peça aconselhamento a um vendedor especializado ou contacte um profissional.

- * Utilize parafusos, anilhas e buchas adaptadas ao tipo de material da sua parede. Estes elementos de fixação não estão incluídos. Para obter aconselhamento sobre os parafusos e ferragens adaptados à sua parede, consulte um vendedor especializado.

IT

ATTENZIONE:

Per evitare un eventuale rischio di ribaltamento, il mobile/l'oggetto deve essere saldamente fissato alla parete. Verificare l'adeguatezza la solidità della parete per essere sicuri che la stessa possa sopportare il carico del mobile/dell'oggetto e resistere alle forze generate a livello di fissaggi. Un montaggio non effettuato correttamente può provocare la caduta del mobile/dell'oggetto e lesioni gravi alle persone. In caso di dubbio circa l'installazione, rivolgetevi a un venditore specializzato o contattate un professionista.

- * Utilizzare viti, rondelle e pernotti (non inclusi) adeguati al tipo di materiale della vostra parete. (non inclusi) Per informazioni su viti e ferramenta adatti alla vostra parete, rivolgetevi a un venditore specializzato.

EL

ΠΡΟΕΙΔΟΠΟΙΗΣΗ:

Για την αποφυγή οποιουδήποτε κινδύνου ανατροπής, το έπιπλο/ αντικείμενο πρέπει να στερεώνεται σταθερά στον τοίχο. Βεβαιωθείτε για την καταλληλότητα και σταθερότητα του τοίχου, προκειμένου να διασφαλίσετε ότι μπορεί να υποστηρίξει το φορτίο του επίπλου/ αντικειμένου και να αντέξει στις δυνάμεις που δημιουργούνται στα σημεία των στηριγμάτων. Η κακή τοποθέτηση μπορεί να οδηγήσει σε πτώση του επίπλου/ αντικειμένου και σοβαρούς τραυματισμούς ατόμων. Σε περίπτωση αμφιβολίας σχετικά με την εγκατάσταση, ζητήστε συμβουλές από έναν εξειδικευμένο πωλητή ή καλέστε έναν επαγγελματία.

- * Χρησιμοποιήστε κατάλληλες βίδες, ροδέλες και ούπα ανάλογα με το υλικό της τοιχοποιίας σας. Τα υλικά αυτά δεν περιλαμβάνονται. Για συμβουλές σχετικά με τις βίδες και τα μεταλλικά στηρίγματα που ενδείκνυνται για τον τοίχο σας, απευθυνθείτε σε έναν εξειδικευμένο πωλητή.

OSTRZEŻENIE:

aby uniknąć ryzyka przewrócenia, mebel/produkt musi zostać solidnie przymocowany do ściany. Sprawdź, czy ściana jest odpowiednia i solidna, aby mieć pewność, że jest w stanie utrzymać obciążenie mebla/produktu i siły na poziomie mocowań.

Nieprawidłowo wykonany montaż może spowodować upadek mebla/produktu prowadzący do poważnych obrażeń ciała. W razie wątpliwości dotyczących montażu, należy zasięgnąć porady u kompetentnego sprzedawcy lub skontaktować się z fachowcem.

* Użyj śrub, podkładek i kołków odpowiednich do rodzaju ściany. Elementy te nie są dołączone do zestawu. Aby zasięgnąć porady na temat odpowiednich śrub i okuć należy skontaktować się z kompetentnym sprzedawcą.

AVERTIZARE:

Pentru a evita orice risc de basculare, această mobilă/acest obiect trebuie fixat/ă bine de perete cu ajutorul dispozitivului de fixare furnizat. Verificați rezistența și soliditatea peretelui, pentru a vă asigura că acesta poate suporta greutatea mobilei/obiectului și poate rezista forțelor generate la nivelul dispozitivelor de fixare. Montarea efectuată greșit poate determina căderea mobilei/obiectului și vătămarea gravă a persoanelor. În caz de dubii privind instalarea, cereți sfatul unui comerciant specializat sau contactați un profesionist.

* Utilizați șuruburi, șaibe și știfturi adaptate tipului de material a peretelui. Acestea nu sunt incluse. Pentru a obține recomandări privind șuruburile și felurile adaptate peretelui dvs., adresați-vă unui comerciant specializat.

WARNING:

To avoid any risk of toppling, this furniture item/object must be securely attached to the wall. Check the suitability and the strength of the wall to ensure that the wall can bear the load of the furniture/object and withstand the forces put on the securing elements. Improper installation can result in the furniture/object falling and cause serious injuries to people. In case of a doubt regarding the installation, ask for advice from a specialised sales assistant or contact a professional.

* Use screws, washers and plugs suited to the type of material of your wall. These are not included. To obtain advice on the screws and fittings suited to your wall, ask a specialised sales assistant.

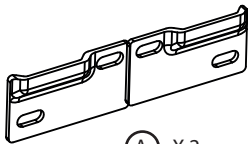
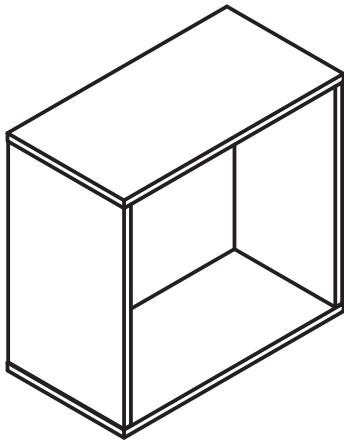

(A) X 2

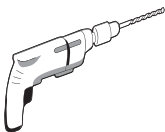
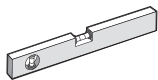
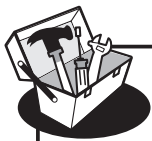
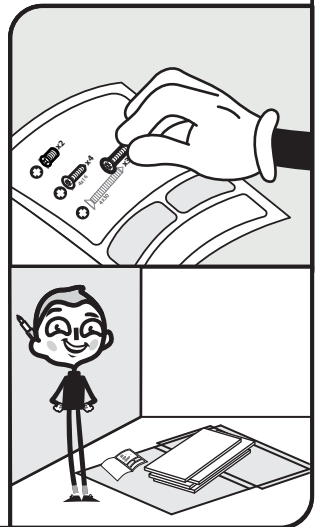
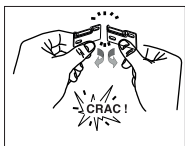

⊕ PZZ



+



X4

1

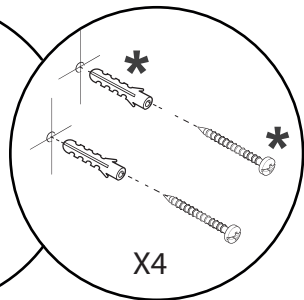
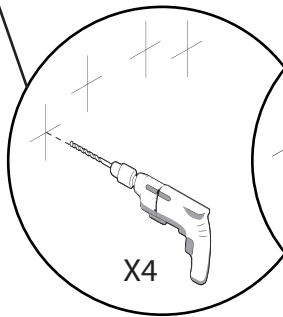
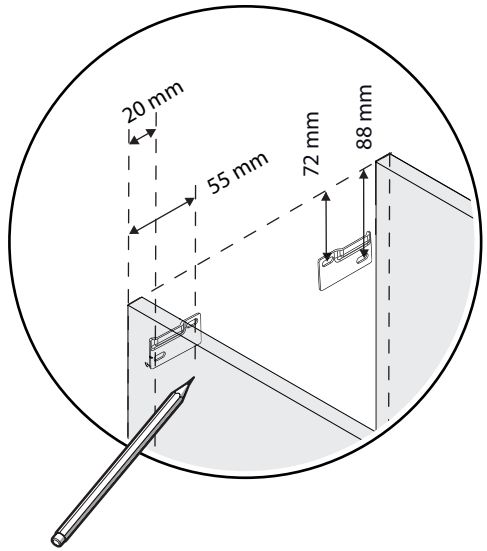
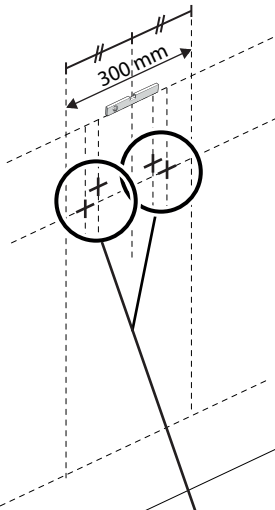
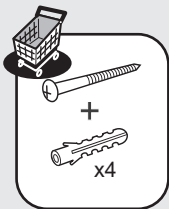
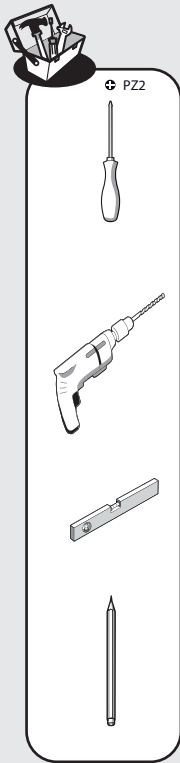
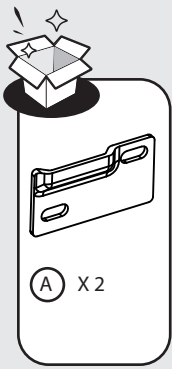

2



PZ2

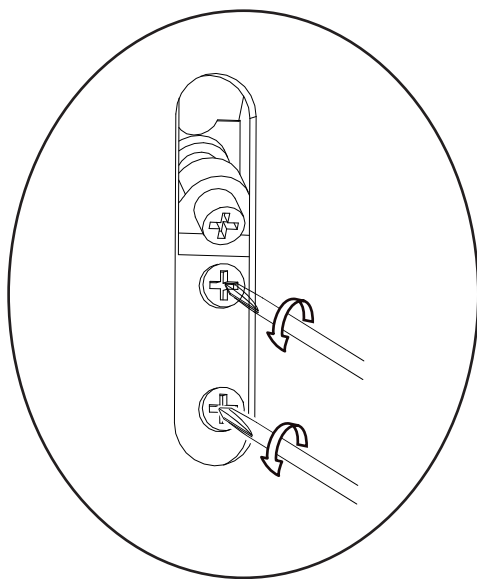
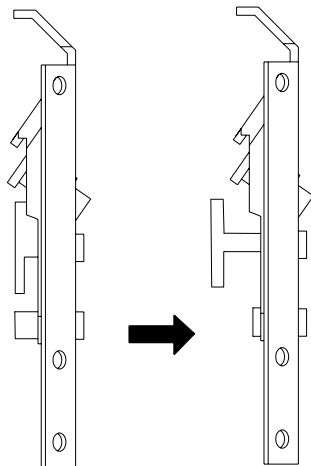
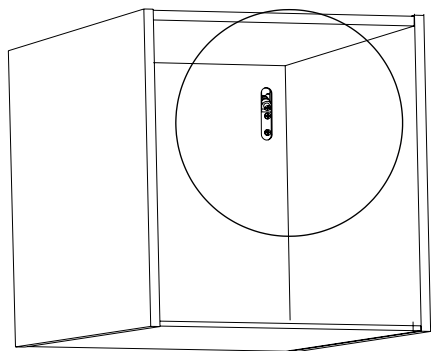



PZ2



3

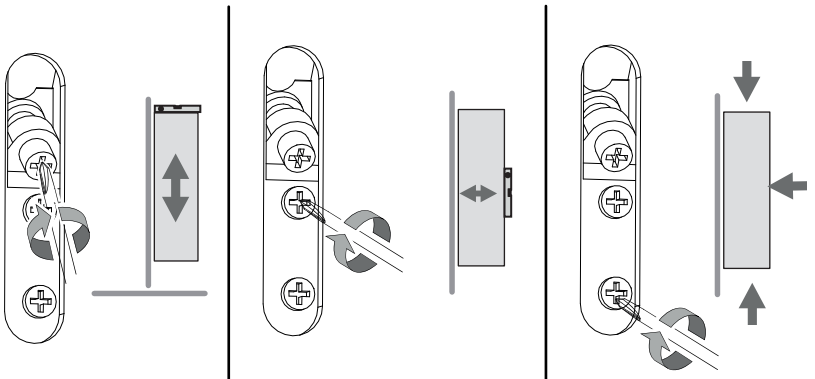
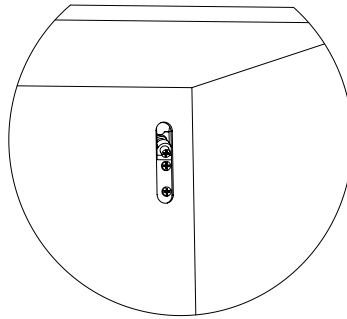
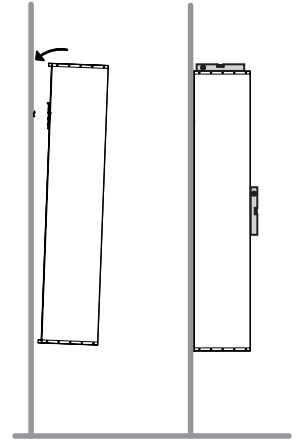
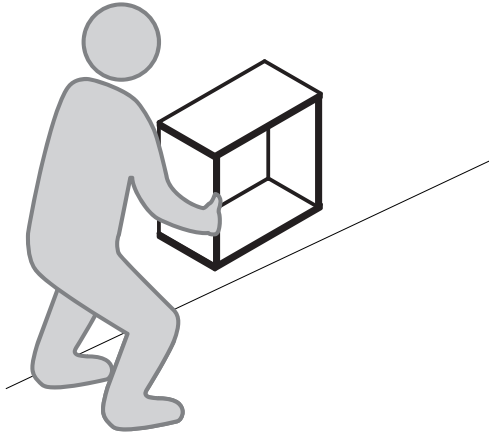

I

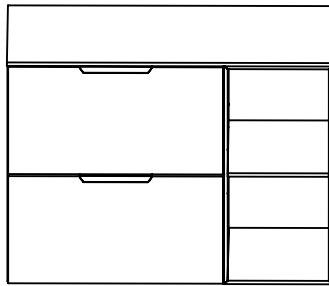
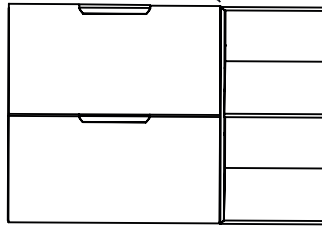
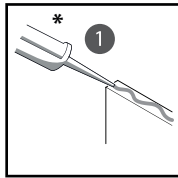
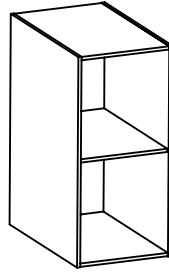
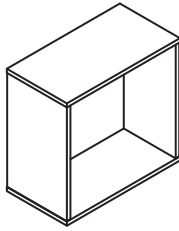



**FR / IMPORTANT, À CONSERVER POUR CONSULTATION
ULTÉRIEURE : À LIRE ATTENTIVEMENT**

**ES / IMPORTANTE, CONSERVAR PARA CONSULTAR
POSTERIORMENTE: LEER ATENTAMENTE**

**PT / IMPORTANTE CONSERVAR PARA FUTURAS
CONSULTAS: POR FAVOR, LEIA COM ATENÇÃO**

**IT / IMPORTANTE, DA CONSERVARE PER ULTERIORE
CONSULTAZIONE: DA LEGGERE ATTENTAMENTE**

**EL / ΣΗΜΑΝΤΙΚΟ! ΚΡΑΤΗΣΤΕ ΤΟ ΓΙΑ ΜΕΛΛΟΝΤΙΚΗ ΑΝΑΦΟΡΑ.
ΔΙΑΒΑΣΤΕ ΤΟ ΠΡΟΣΕΚΤΙΚΑ**

**PL / WAŻNE, PRZECZYTAĆ UWAŻNIE I ZACHOWAĆ NA
PRZYSZŁOŚĆ**

**RO / IMPORTANT, A SE PASTRA PENTRU CONSULTAREA
ULTERIOARA: CITIȚI CU ATENȚIE**

**EN / IMPORTANT, TO BE RETAINED FOR FUTURE
REFERENCE: PLEASE READ CAREFULLY**



Ce meuble se recycle,
s'il n'est plus utilisable
déposez-le en déchèterie.

Notice à trier.

Pour en savoir plus :
www.quefairedemesdechets.fr

ES Si ya no puede utilizarse, este mueble se puede reciclar, deposítelo en la unidad de clasificación de residuos.

PT Este móvel é reciclável. Quando deixar de ser utilizado, deposite-o num centro de reciclagem de resíduos.

IT Questo mobile può essere riciclato, portatelo in un'isola ecologica se inutilizzabile.

EL Το έπιπλο αυτό είναι ανακυκλώσιμο, εάν δεν μπορεί πλέον να χρησιμοποιηθεί τοποθετήστε το σε χώρο αποβλήτων.

PL Mebel ten poddawany jest recyklingowi, kiedy przestaje być użyteczny należy go dostarczyć do punktu zbiórki odpadów.

RO Acest mobilier s poate fi reciclat, dacă nu mai poate fi utilizat aruncați-l la groapă de gunoi.

EN This piece of furniture is recyclable. If it cannot be used anymore, please take it to the waste recycling centre.



* Garantie 5 ans / 5 años de garantía / Garantia de 5 años / Garanzia 5 Anni / Εγγύηση 5 ετών / Gwarancja 5-letnia / Гарантія 5 років / 5-year guarantee

Made in Italy

FR ADEO Services - 135 rue sadi Carnot - CS00001 - 59790 RONCHIN
FRANCE

