

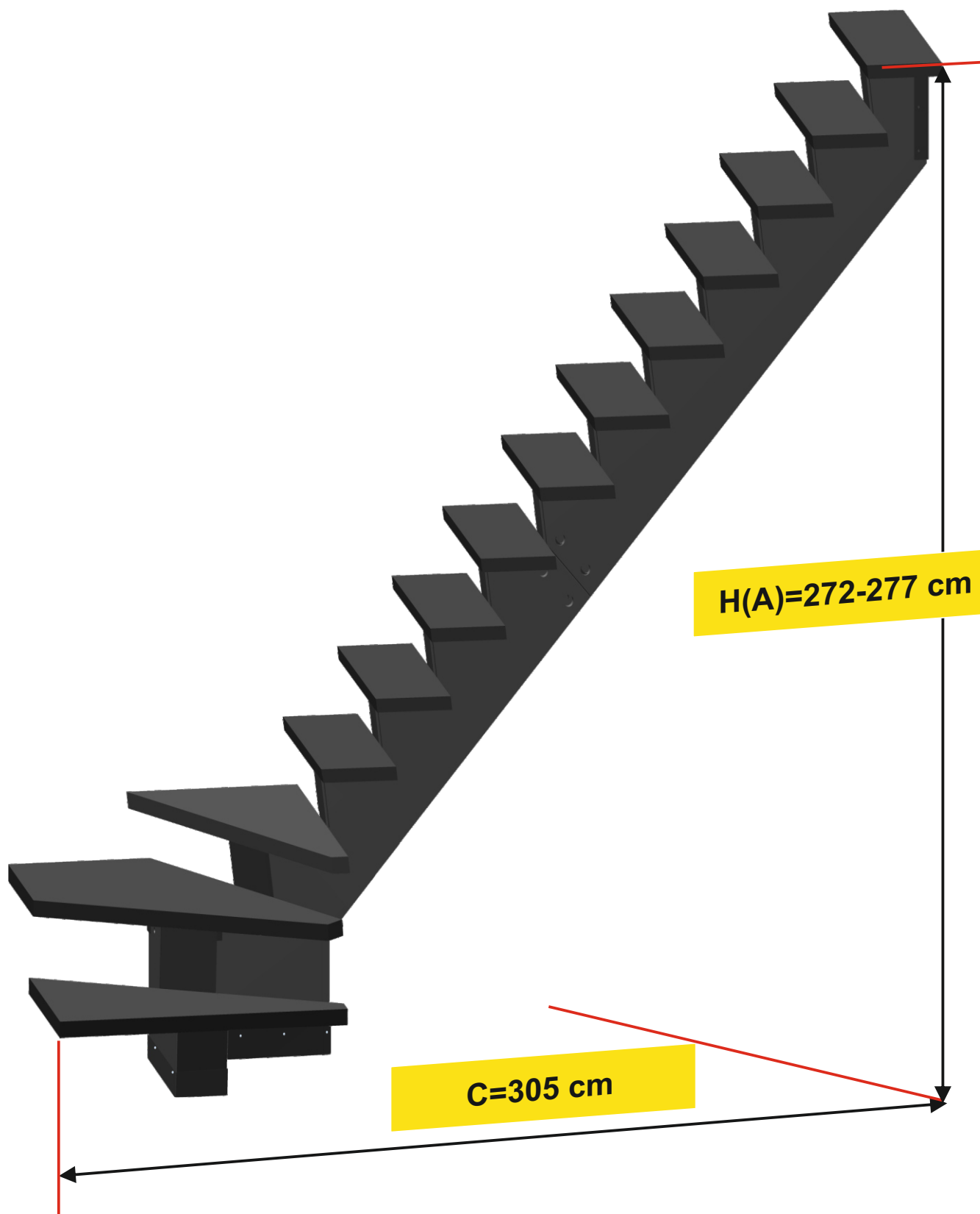

Video 

 www.leroymerlin.fr



GOMERA ESCALIER QT, H 2770 mm



<p>01 80033000</p>  <p>1946x390x150mm =1</p>	<p>02 80033002-D 80033003-G</p>  <p>1860x390x150mm =1</p>	<p>03 80032009-D 80032010-G</p>  <p>350x380x150mm =1</p>	<p>04 80032000</p>  <p>275x850x40mm =10</p>
<p>05 80032001</p>  <p>285x850x040mm =1</p>	<p>06 80032003-D 80032006-G</p>  <p>538x855x40mm =1</p>	<p>07 80032004-D 80032007-G</p>  <p>1198x624x40mm =1</p>	<p>08 80032005-D 80032008-G</p>  <p>850x425x40mm =1</p>
<p>09 80032011</p>  <p>900x80x40 mm =1</p>	<p>10 80032002</p>  <p>700x80x40 mm =12</p>	<p>11 80032012</p>  <p>500x80x40 mm =1</p>	<p>12 80031000</p>  <p>Φ5x25 mm =84+2</p>
<p>13 80031001</p>  <p>M8x160mm =4</p>	<p>14 80031003 80031002</p>  <p>a Φ40xΦ37x19mm =8 b 35x11x18mm =8</p>	<p>15 80031050</p>  <p>M6x50mm =24+1</p>	<p>16 80031051</p>  <p>M8 =8</p>
<p>17 80031013</p>  <p>Φ10x40mm =4</p>	<p>18 80031005</p>  <p>M12xØ16x80mm =8</p>	<p>19 80031014 80031015</p>  <p>a M10x55mm =4 b Φ20x20xmm =4</p>	<p>20 80031051</p>  <p>Φ16x15 mm =24</p>
<p>21 70031037</p>  <p>M8 =4</p>	<p>22 70041007</p>  <p>Φ7x40mm =21+1</p>	<p>23 70041027</p>  <p>Φ6,3x60mm =32+2</p>	<p>24 70041031 70041037</p>  <p>a Φ20x5mm =54+2 b Φ20x4mm =4</p>
<p>25 70041032</p>  <p>Φ53x6 mm =8+1</p>	<p>26 80032015-D 80032016-G</p>  <p>459x161x88mm =1</p>	<p>27 80032017</p>  <p>358x161x88mm =1</p>	<p>28 80032013</p>  <p>310x161x48mm =1</p>
<p>29 80032019</p>  <p>350x150x10mm =5</p>	<p>30 80031010</p>  <p>hex 4mm =1</p>	<p>31 80031011</p>  <p>20 ml =1</p>	<p>32 80032020</p>  <p>450x150x10mm =5</p>

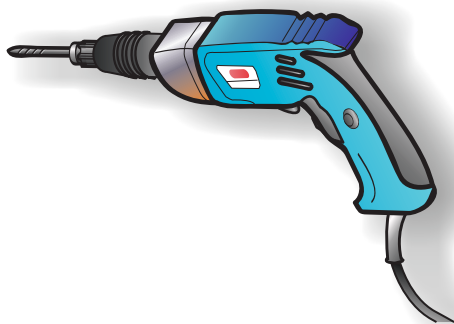
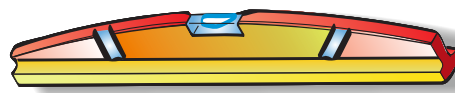
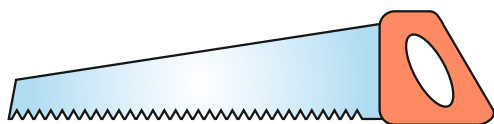
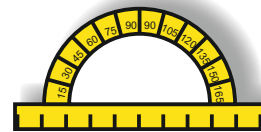

● Pz2

● Ph2, Ph3



13 mm
10



19 mm

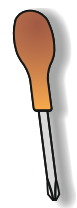
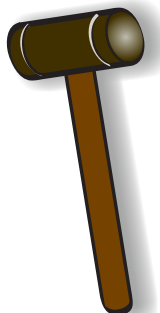

Pz2



Ph2



Φ12 x 120mm



Φ 5 x 70mm

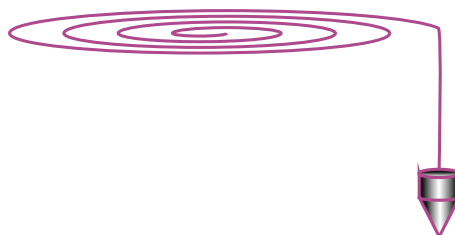

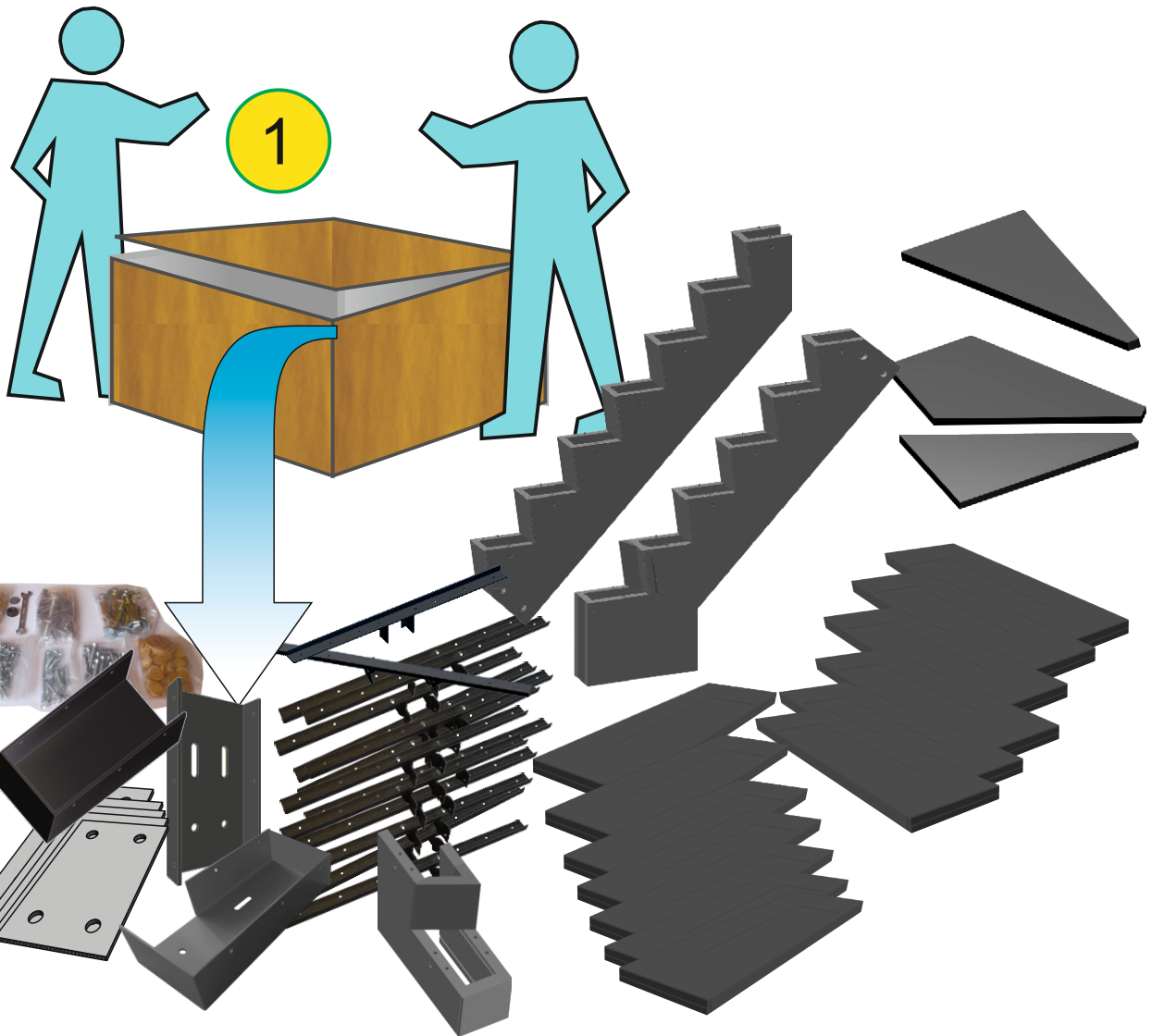

1

2

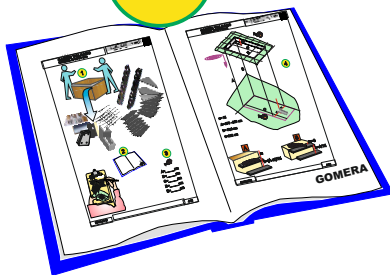

3

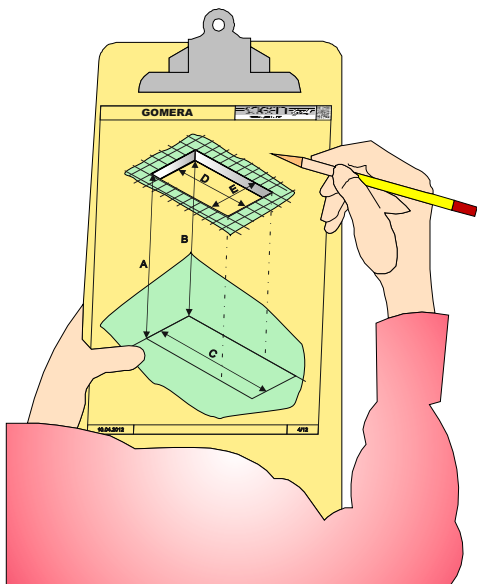

- A= _____ cm
- B= _____ cm
- C= _____ cm
- D= _____ cm
- E= _____ cm

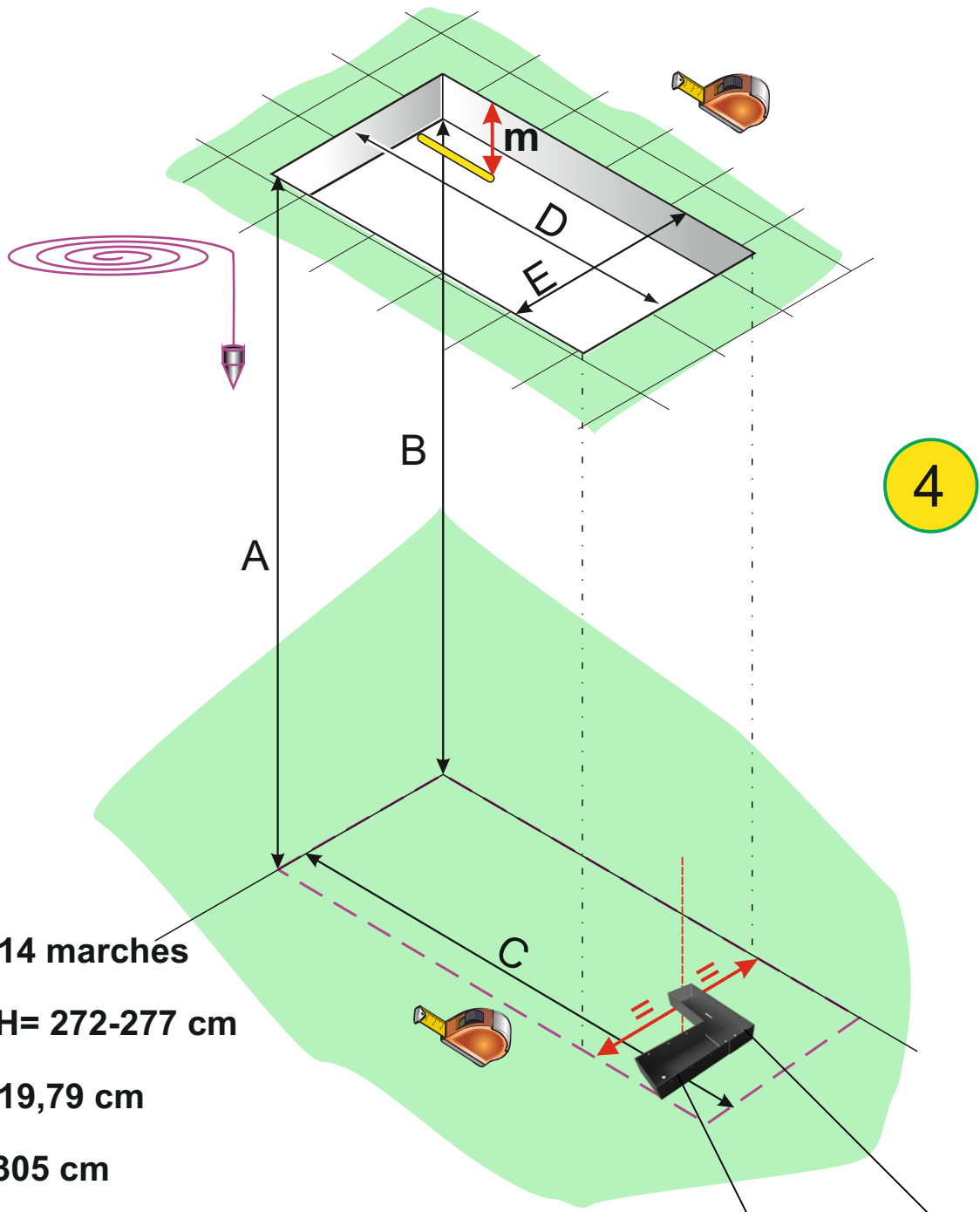

n= 14 marches

(A)H= 272-277 cm

h= 19,79 cm

C=305 cm

27

26

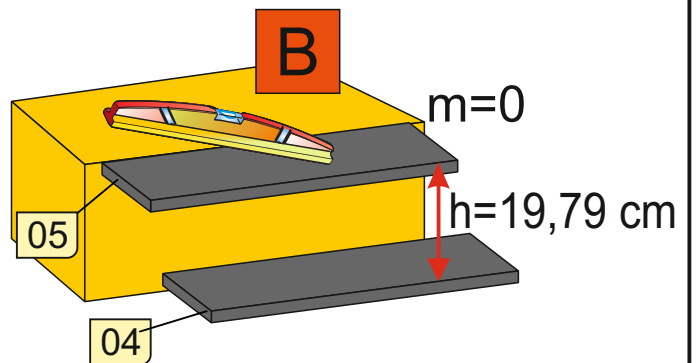
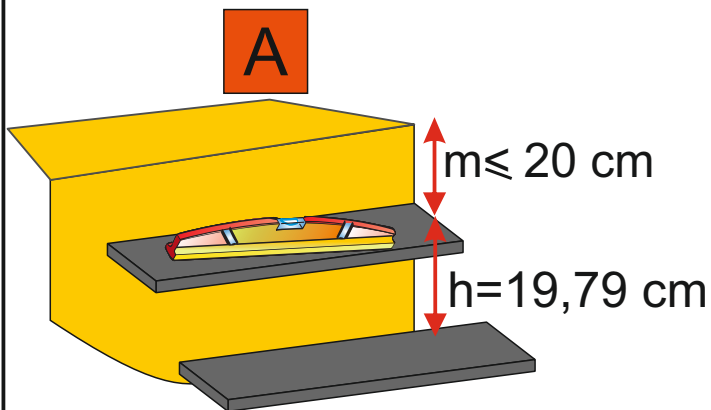

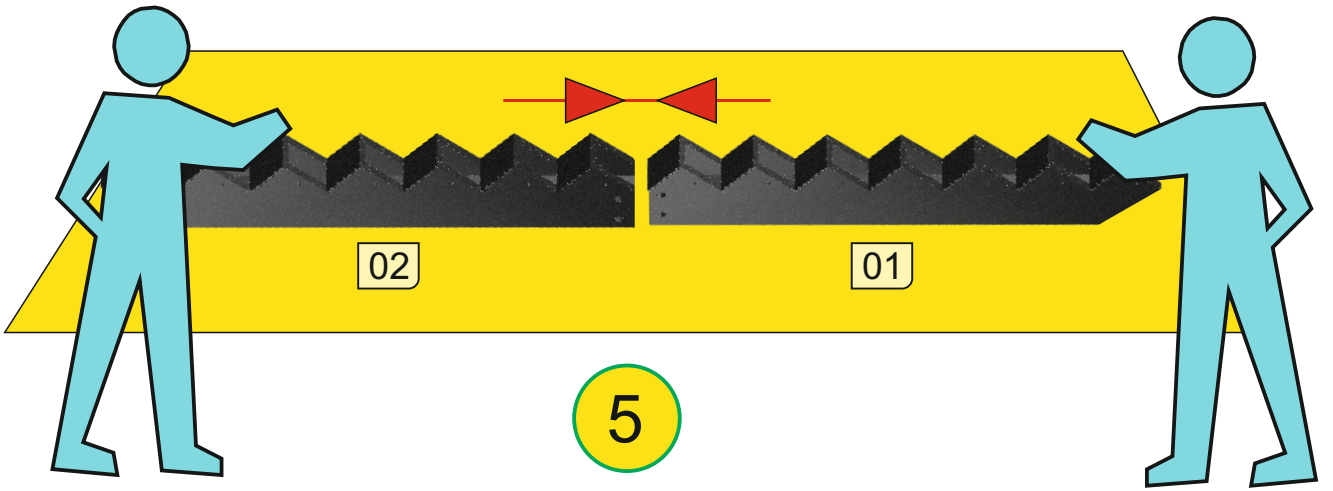

01

16

14 a+b

13

14 b

14 a

16

02

25a

13mm

13 + 14 a+b + 16

25

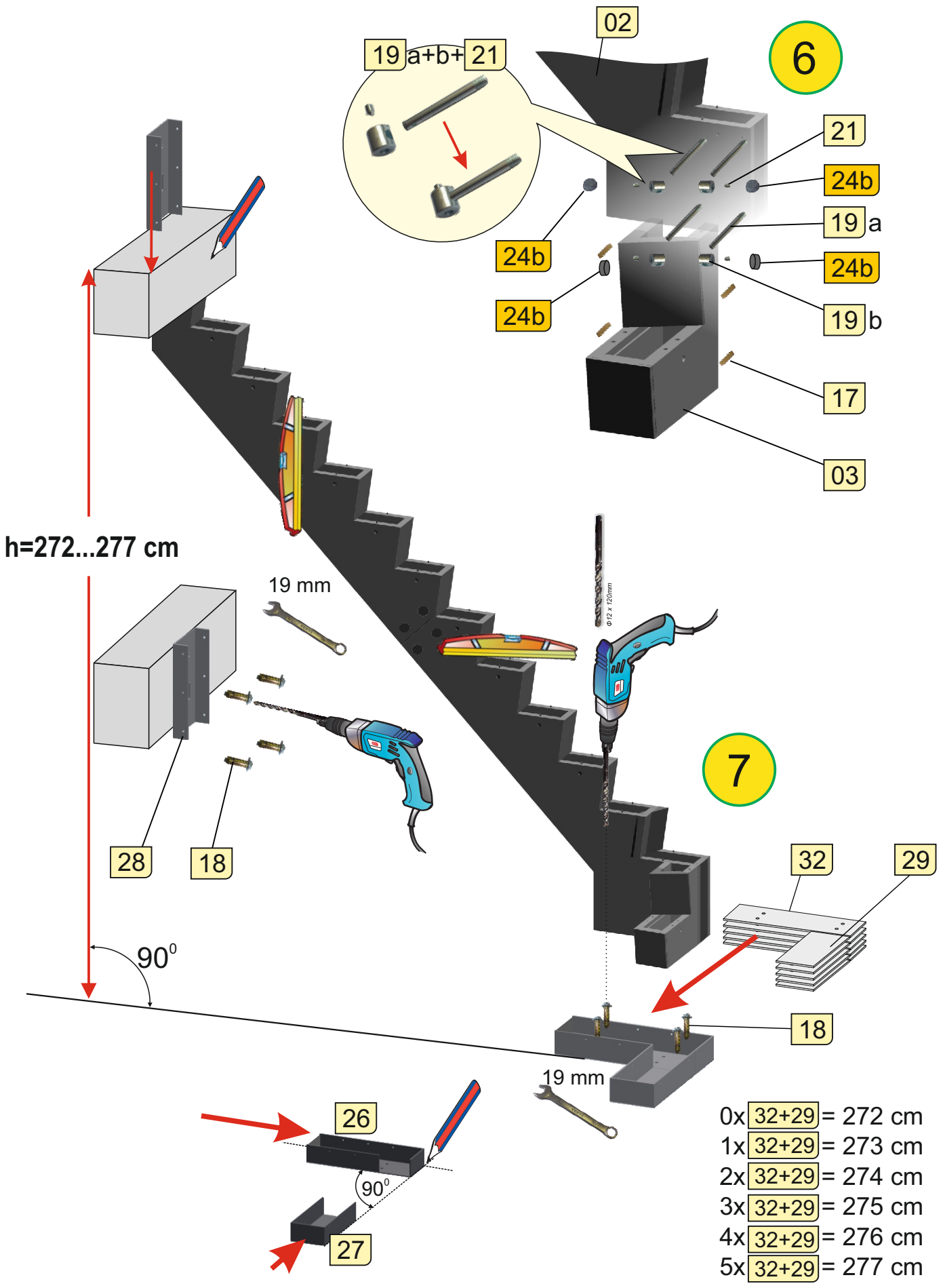

- 0x $\boxed{32+29} = 272$ cm
- 1x $\boxed{32+29} = 273$ cm
- 2x $\boxed{32+29} = 274$ cm
- 3x $\boxed{32+29} = 275$ cm
- 4x $\boxed{32+29} = 276$ cm
- 5x $\boxed{32+29} = 277$ cm

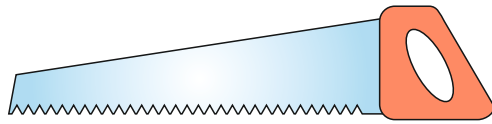
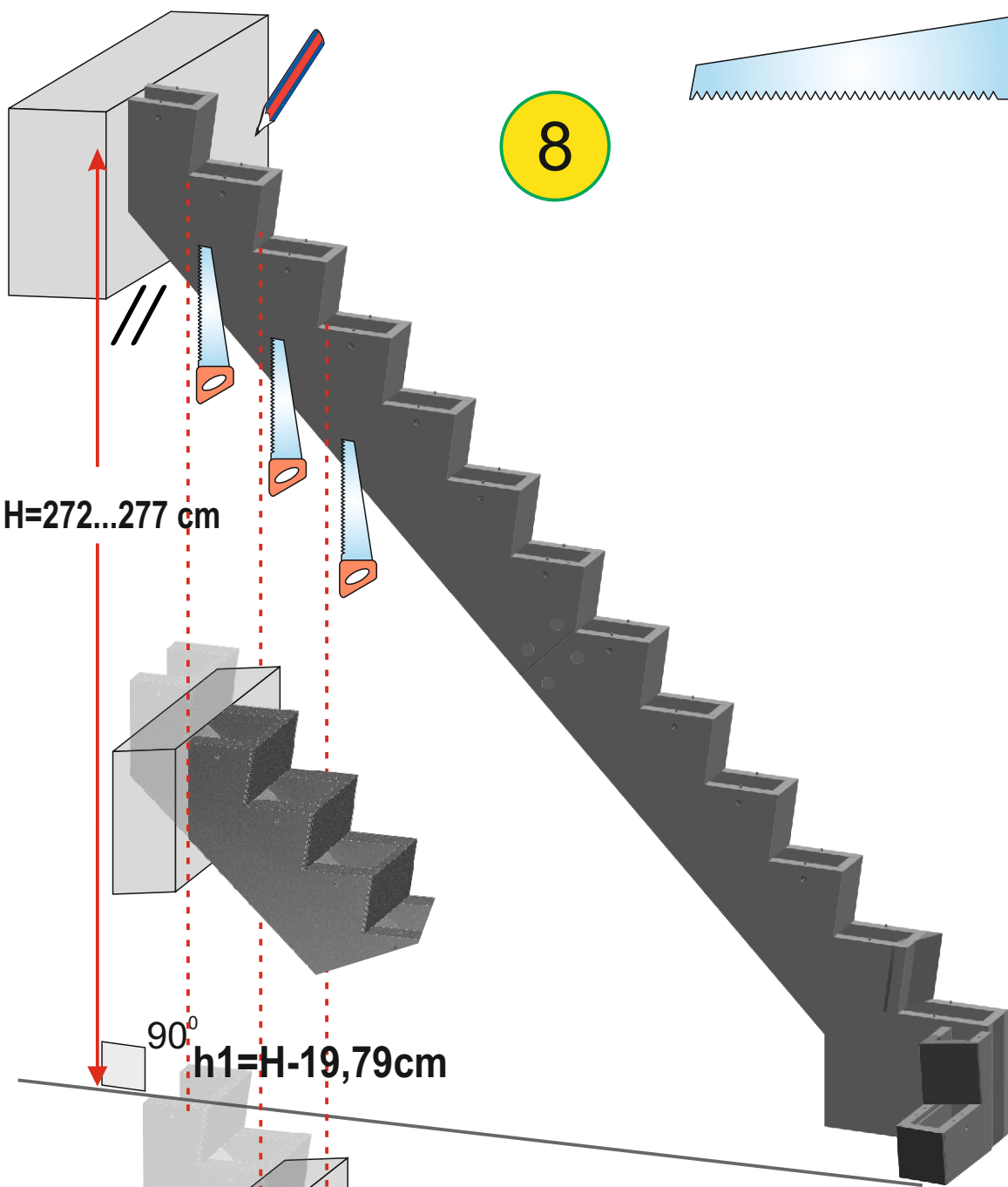

8

H=272...277 cm

90°
h1=H-19,79cm

h2=H-2x19,79cm

h3=H-3x19,79cm



9

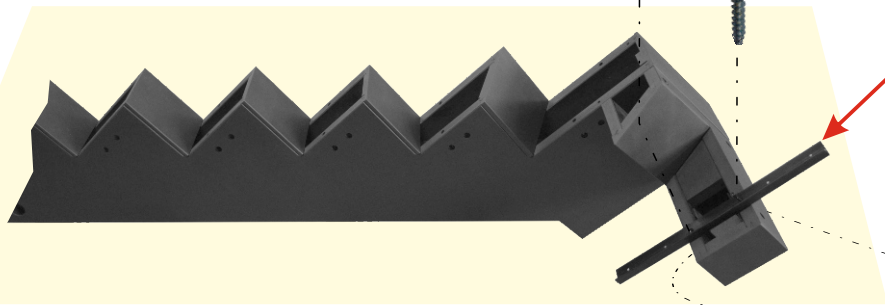
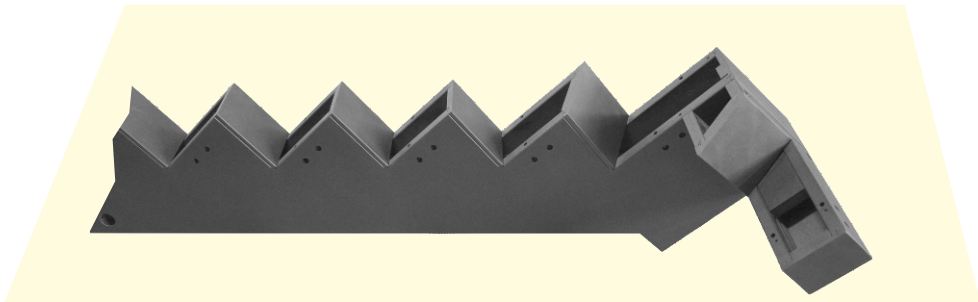

A 22 x 2



11 x 1

B 23 x 2

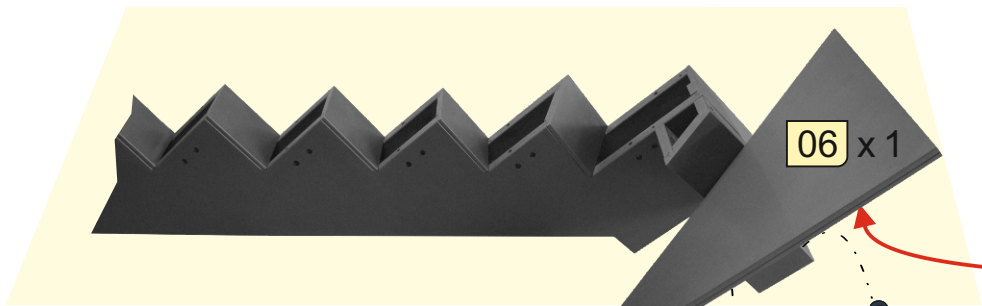

06 x 1

03 x 4



24a x 4

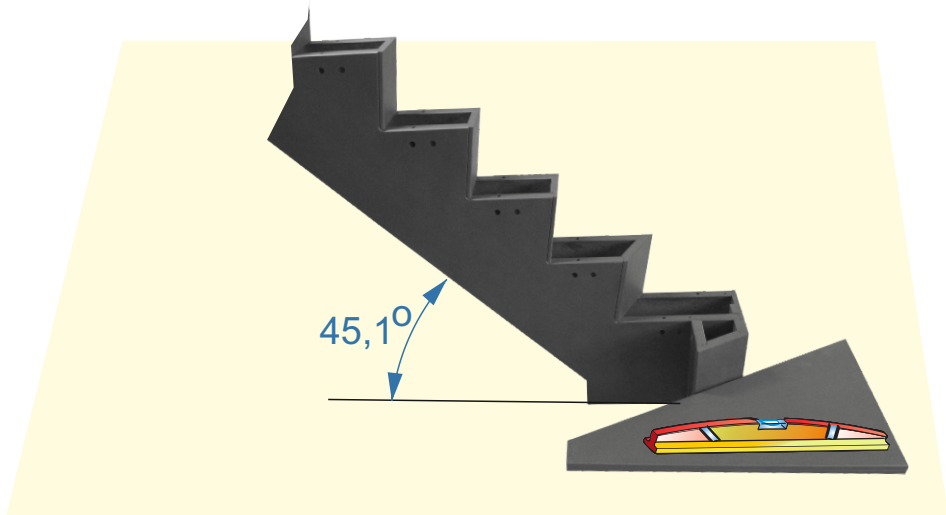

45,1°



10

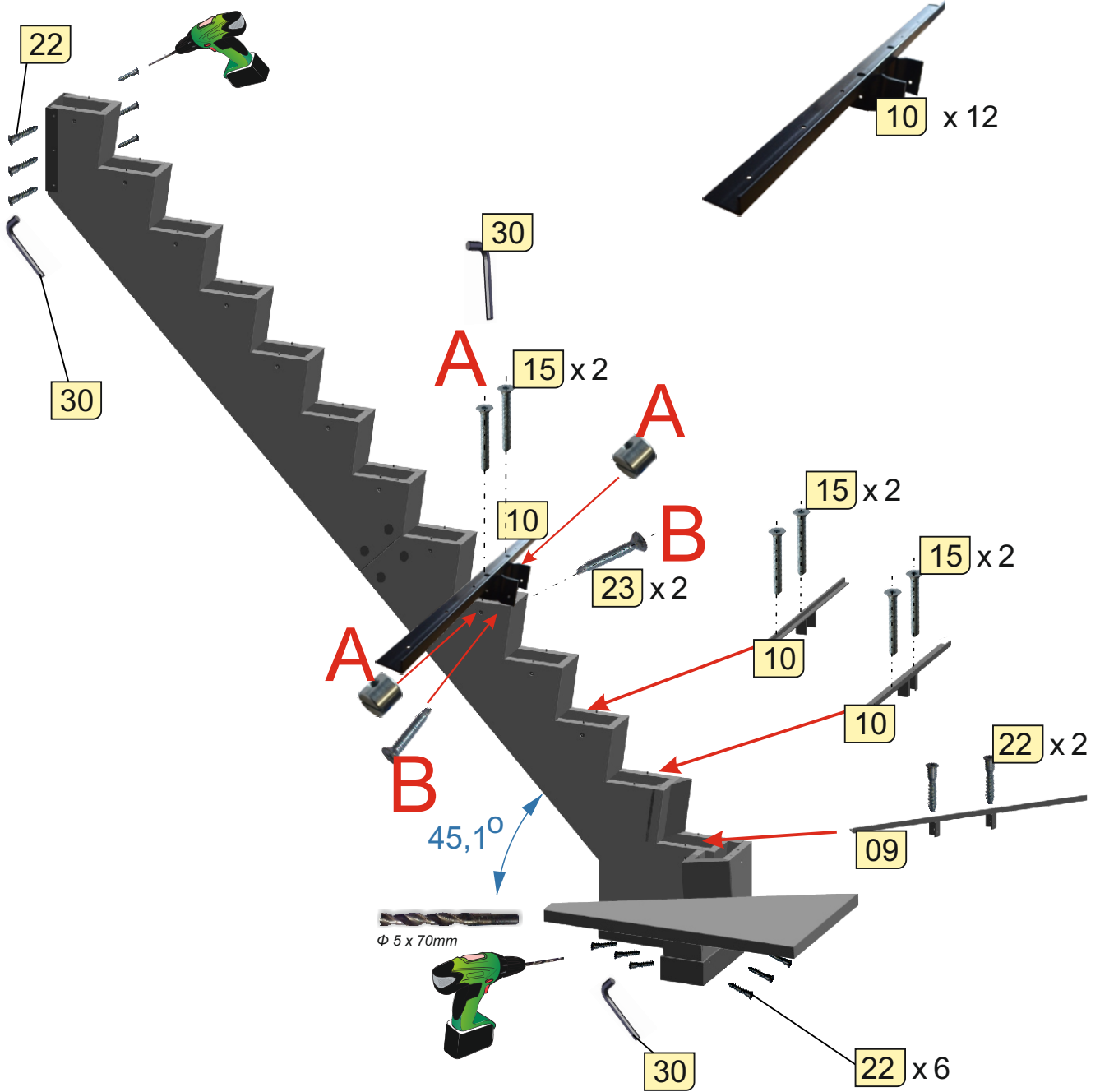



kit LED

11





12

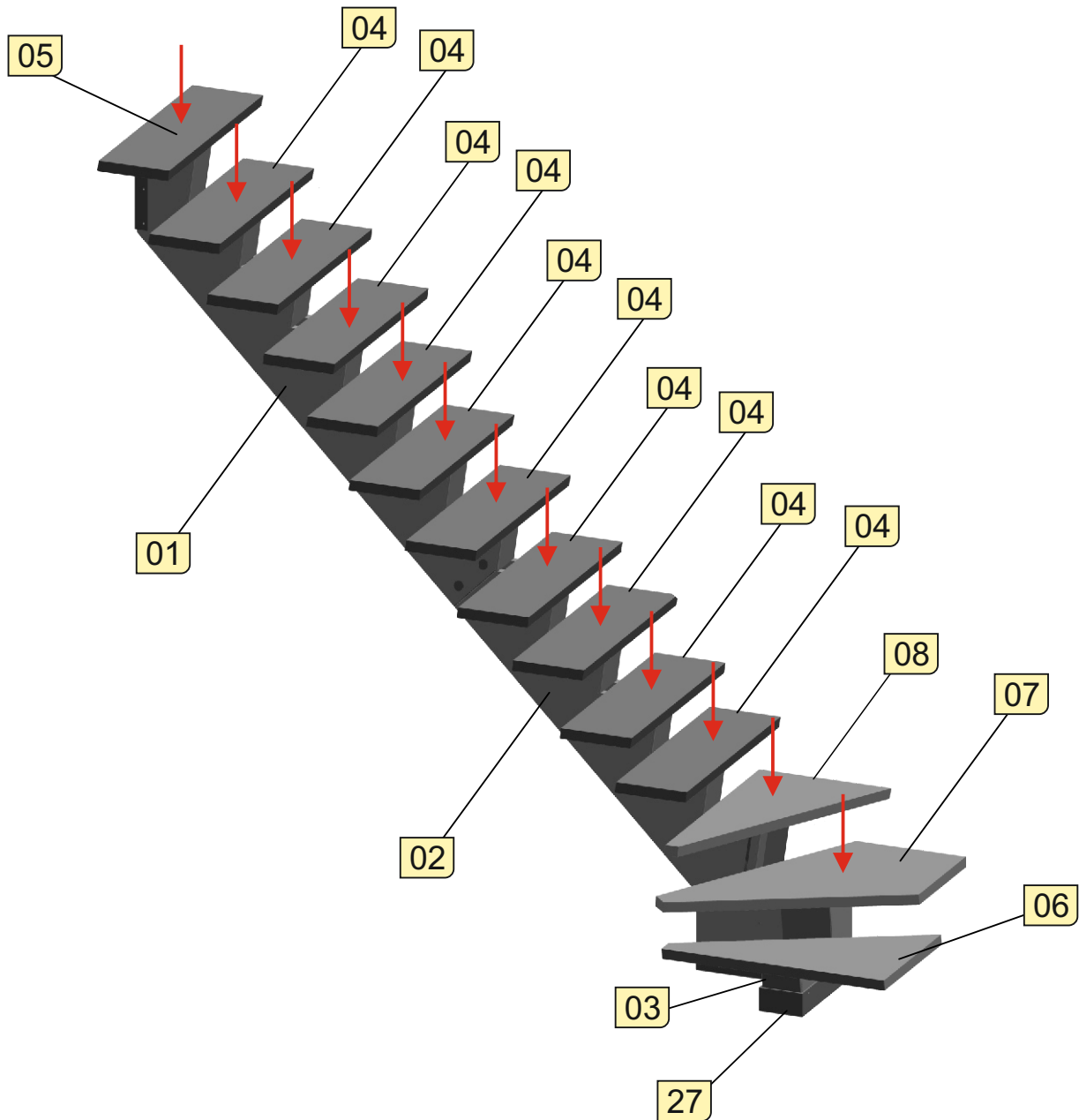



13

