

**delinia**

Guarantee  
**10**  
years

HOLLY

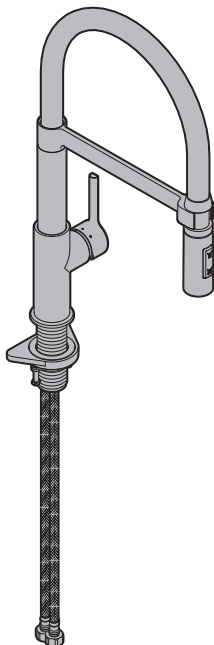

EAN CODE : 3276000592464

**FR** Manuel d'Instructions

**ES** Manual de Instrucciones

**PT** Manual de Instruções

**IT** Manuale di Istruzioni

**EL** Εγχειρίδιο Οδηγιών

**PL** Instrukcja Obsługi

**RU** Руководства по  
Эксплуатации

**KZ** Пайдаланушы Нұсқаулығы

**UA** Інструкція з Експлуатації

**RO** Manual de Instrucțiuni

**BR** Manual de Instruções

**EN** Instructions Manual

2020/05/01

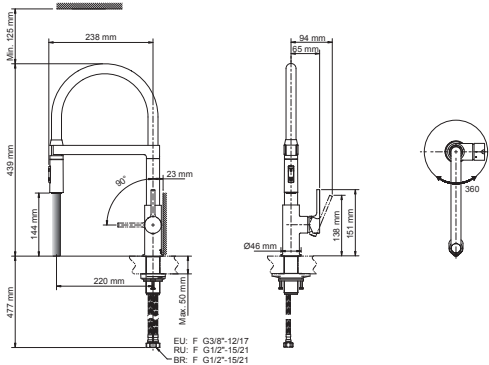

B

A

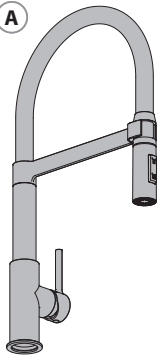

C



D



E



F1



F2



G



H



BR



PH2





FR: Préparation / ES: Preparación / PT: Preparação / IT: Preparazione / EL: Προετοιμασία /  
PL: Przygotowanie / RU: Подготовка / KZ: Дайындау / UA: Підготування / RO: Pregătire / BR: Preparação /  
EN: Preparation

 4



FR: Montage / ES: Montaje / PT: Montagem / IT: Montaggio / EL: Συναρμολόγηση /  
PL: Montaż / RU: Сборка / KZ: Монтаждау / UA: Збірка / RO: Montaj / BR: Montagem /  
EN: Assembly

 5 → 7



FR: Utilisation eau chaude-eau froide/ ES: Utilización agua caliente-agua fría/ PT: Utilização água quente-água fria/  
IT: Uso acqua calda-acqua fredda/ EL: Χρήση ζεστής-κρύου νερού/ PL: Użytkowanie zimnej wody-gorącej wody/  
RU: Використання гарячої води/ KZ: Суық және ыстық суды қолдану/ UA: води - холодної води/  
RO: Utilizare apă caldă-apă rece/ BR: Uso de água quente e fria/ EN: Using hot and cold water

 8

FR: Changement de cartouche/ ES: Cambio de cartucho/ PT: Mudança de cartucho/ IT: Cambio cartuccia/  
EL: Αλλαγή φωτογείου/ PL: Wymiana wkładu/ RU: Смена картриджа/ KZ: Картриджді ауыстыру/  
UA: Заміна картриджа/ RO: Schimbare cartus/ BR: Substituição de cartucho/ EN: Replacing the cartridge

 9 → 12

FR: Changement de mousseur/ ES: Cambio de aireador/ PT: Mudança de arejador/ IT: Cambio rompigetto/  
EL: Αλλαγή αεράτορα/ PL: Wymiana perlatora/ RU: Смена аэратора/ KZ: Ауақанықтырғышты ауыстыру/  
UA: Заміна аератора/ RO: Schimbare aerator/ BR: Substituição do aerador/ EN: Replacing the aerator

 13

FR: Changement de flexibles/ ES: Cambio de flexibles/ PT: Mudança de flexíveis/ IT: Cambio flessibili/  
EL: Αλλαγή λάστιχων/ PL: Wymiana wężyków instalacyjnych / RU: Смена гибкого шланга для смесителя/  
KZ: Қоспауышқа арналған иілгіш шлангты ауыстыру/ UA: Заміна гнучкого шланга для змішувача/  
RO: Schimbare furtune flexibile/ BR: Substituição das mangueiras/ EN: Replacing the hoses

 14 → 15



FR: Préparation / ES: Preparación / PT: Preparação / IT: Preparazione / EL: Προετοιμασία /  
PL: Przygotowanie / RU: Подготовка / KZ: Дайындау / UA: Підготовка / RO: Pregătire /  
BR: Preparação / EN: Preparation

1

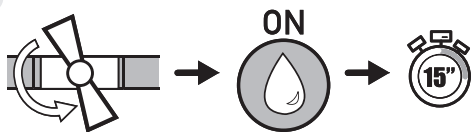

2

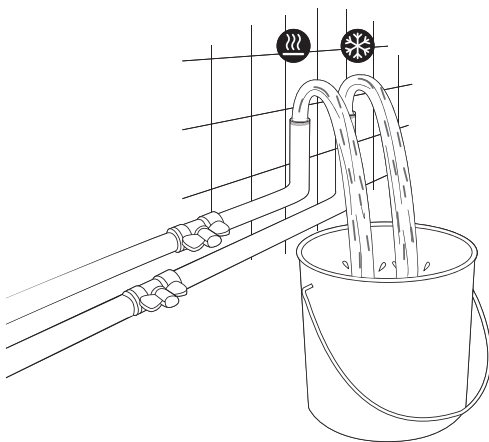

3

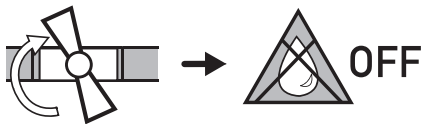

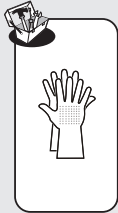
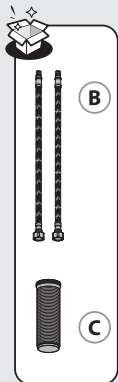

FR: Montage / ES: Montaje / PT: Montagem / IT: Montaggio / EL: Συνορμολόγηση /  
 PL: Montaż / RU: Сборка / KZ: Монтаждау / UA: Збірка / RO: Montaj / BR: Montagem /  
 EN: Assembly

1

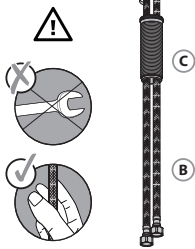
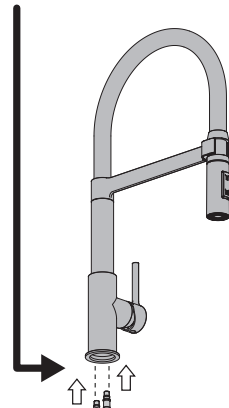
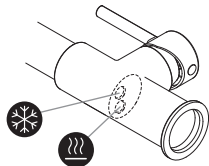

2

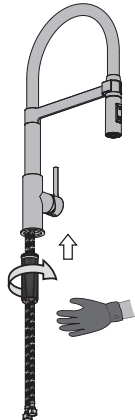

3

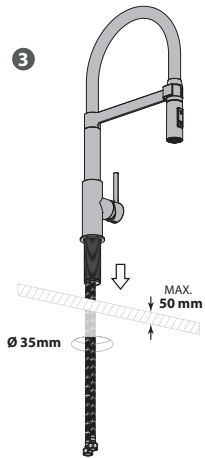

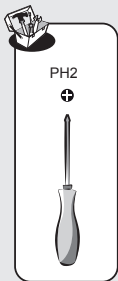
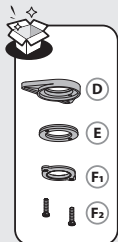

2

1

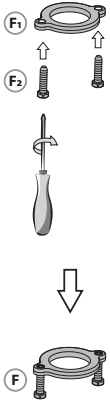

2

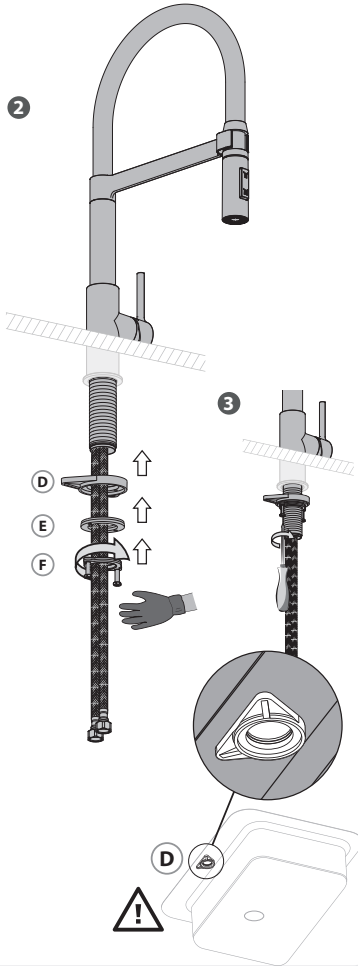



3

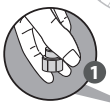
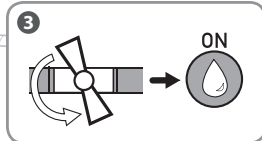
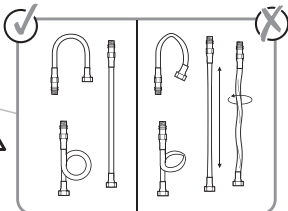
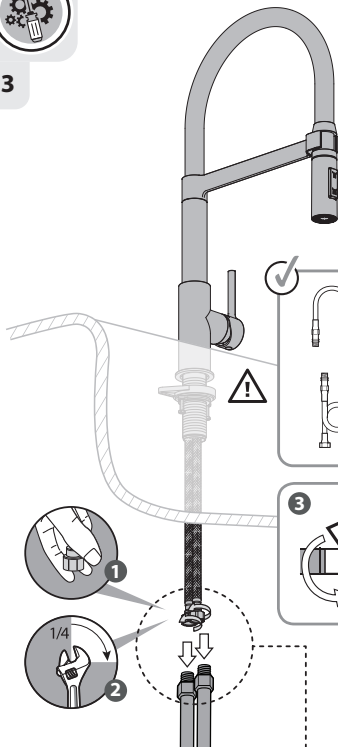

BR

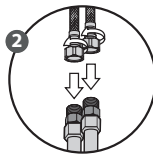
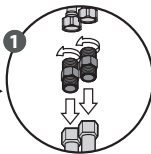



FR: Utilisation eau chaude-eau froide/ ES: Utilización agua caliente-agua fría/ PT: Utilização água quente-água fria/  
IT: Uso acqua calda-acqua fredda/ EL: Χρήση ζεστού-κρύου νερού/ PL: Użytkowanie zimnej wody-gorącej wody/  
RU: Використання гарячої води/ KZ: Суық және ыстық суды қолдану/ UA: води - холодної води/  
RO: Utilizare apă caldă-apă rece/ BR: Uso de água quente e fria/ EN: Using hot and cold water

1

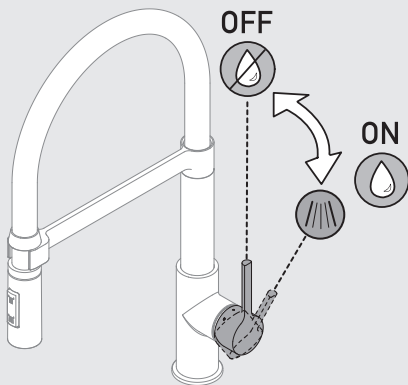

2

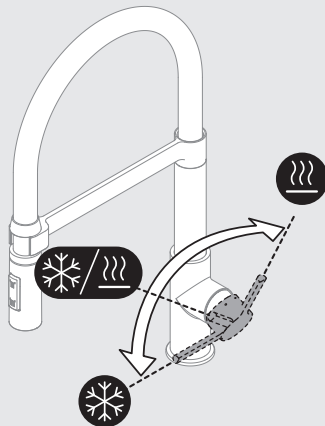



FR: Changement de cartouche/ ES: Cambio de cartucho/ PT: Mudança de cartucho/ IT: Cambio cartuccia/  
EL: Αλλαγή φουσιγγίου/ PL: Wymiana wkładu/ RU: Смена картриджа/ KZ: Картриджкі ауыстыру/  
UA: Заміна картриджа/ RO: Schimbare cartus/ BR: Substituição de cartucho/ EN: Replacing the cartridge

1

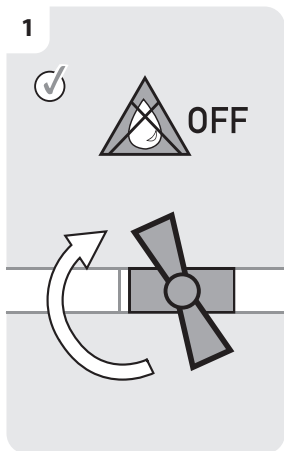

2

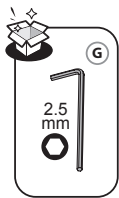
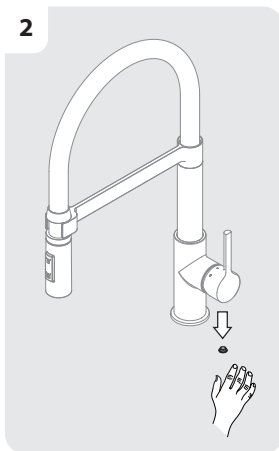

3

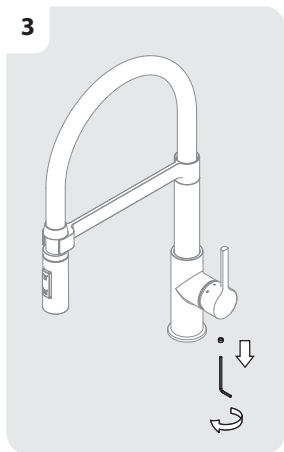

4

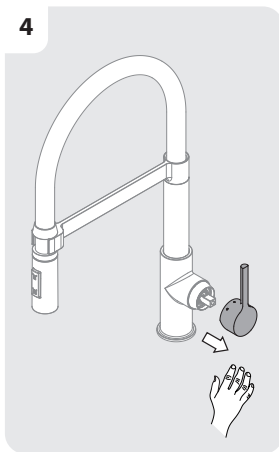



FR: Changement de cartouche/ ES: Cambio de cartucho/ PT: Mudança de cartucho/ IT: Cambio cartuccia/  
EL: Αλλαγή φουσιγγίου/ PL: Wymiana wkładu/ RU: Смена картриджа/ KZ: Картриджкі ауыстыру/  
UA: Заміна картриджа/ RO: Schimbare cartus/ BR: Substituição de cartucho/ EN: Replacing the cartridge

5

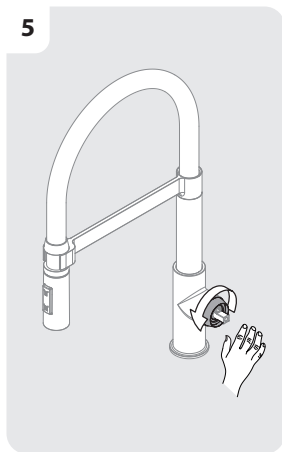

6

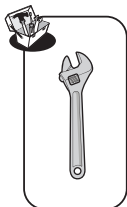
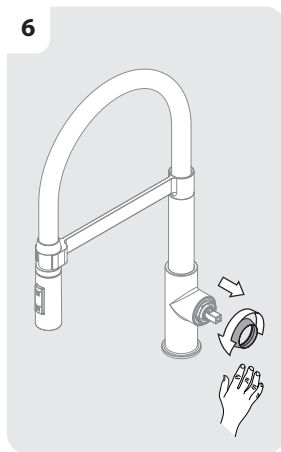

7

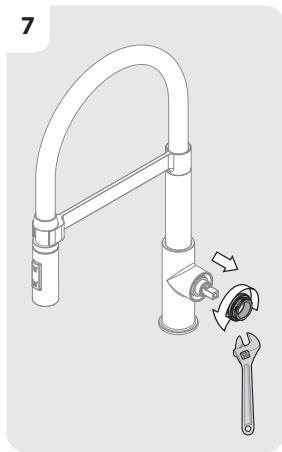

8



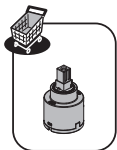
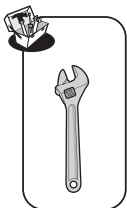

FR: Changement de cartouche/ ES: Cambio de cartucho/ PT: Mudança de cartucho/ IT: Cambio cartuccia/  
EL: Αλλαγή φουσιγγίου/ PL: Wymiana wkładu/ RU: Смена картриджа/ KZ: Картриджкі ауыстыру/  
UA: Заміна картриджа/ RO: Schimbare cartus/ BR: Substituição de cartucho/ EN: Replacing the cartridge

9

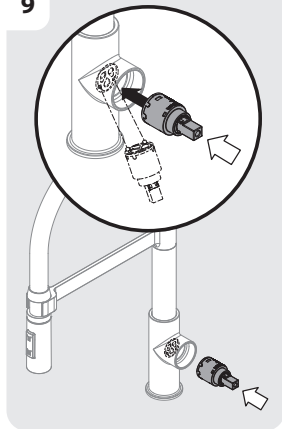

10

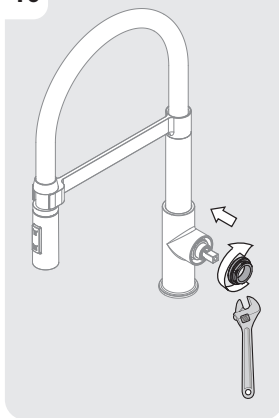

11

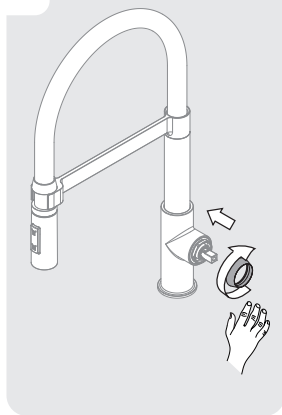

12

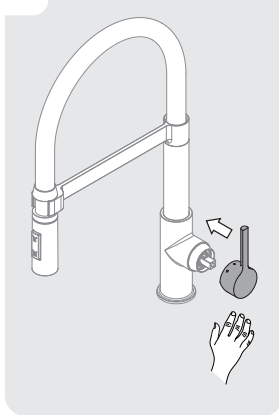

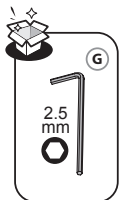

FR: Changement de cartouche/ ES: Cambio de cartucho/ PT: Mudança de cartucho/ IT: Cambio cartuccia/  
EL: Αλλαγή φουσιγγίου/ PL: Wymiana wkładu/ RU: Смена картриджа/ KZ: Картриджкі ауыстыру/  
UA: Заміна картриджа/ RO: Schimbare cartus/ BR: Substituição de cartucho/ EN: Replacing the cartridge

13

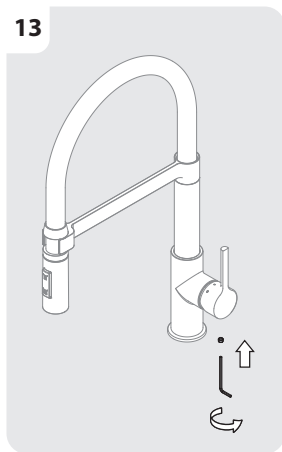

14

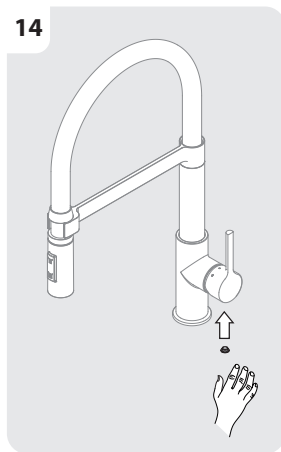

15

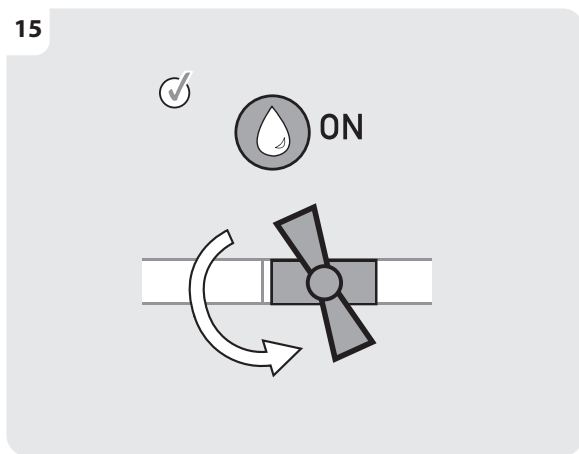

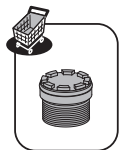
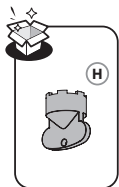

FR: Changement de mousseur/ ES: Cambio de aireador/ PT: Mudança de arejador/ IT: Cambio rompigetto/  
 EL: Αλλαγή αεράτορα/ PL: Wymiana perlatora/ RU: Смена аэратора/ KZ: Ауақанықтығыршытты ауыстыру/  
 UA: Заміна аератора/ RO: Schimbare aerator/ BR: Substituição do aerador/ EN: Replacing the aerator

1

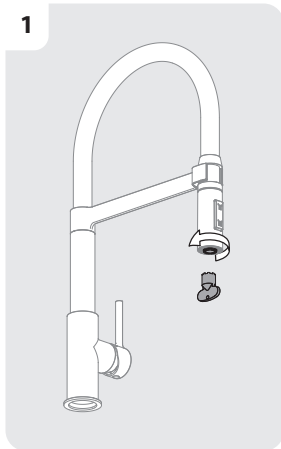

2

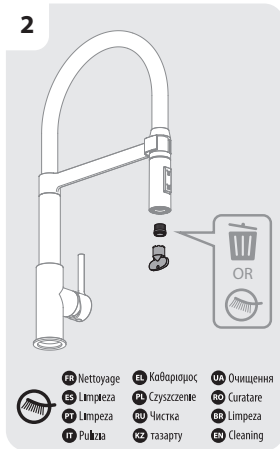

3

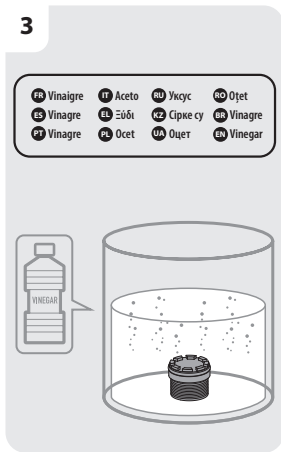

- |    |          |    |       |    |          |    |         |
|----|----------|----|-------|----|----------|----|---------|
| FR | Vinaigre | ES | Aceto | RU | Уксус    | RO | Oțet    |
| EL | Vinagre  | CZ | Σόδι  | CZ | Сирке су | BR | Vinagre |
| PL | Vinagre  | UA | Оцет  | UA | Оцет     | EN | Vinegar |

4

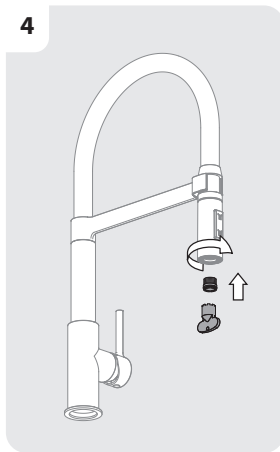

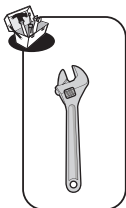

FR: Changement de flexibles/ ES: Cambio de flexibles/ PT: Mudança de flexíveis/ IT: Cambio flessibili/  
EL: Αλλαγή λάστιχων/ PL: Wymiana wężyków instalacyjnych / RU: Замена гибкого шланга для смесителя/  
KZ: Қоспаулауышқа арналған иінгіш шлангты ауыстыру/ UA: Заміна гнучкого шланга для змішувача/  
RO: Schimbare furtune flexibile/ BR: Substituição das mangueiras/ EN: Replacing the hoses

1

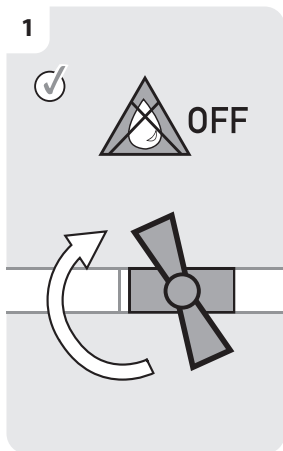

2

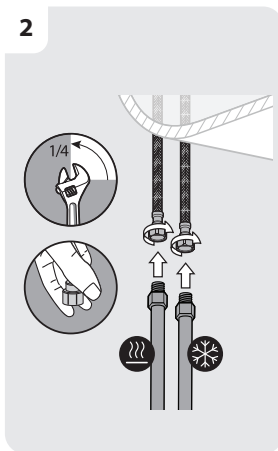

3

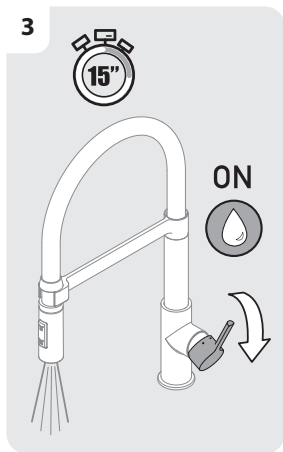

4

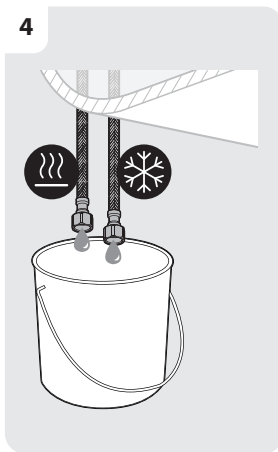

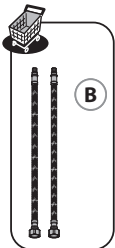

FR: Changement de flexibles/ ES: Cambio de flexibles/ PT: Mudança de flexíveis/ IT: Cambio flessibili/  
 EL: Αλλαγή λάστιχων/ PL: Wymiana wężyków instalacyjnych / RU: Замена гибкого шланга для смесителя/  
 KZ: Қоспаулышқа арналған иінгіш шлангты ауыстыру/ UA: Заміна гнучкого шланга для змішувача/  
 RO: Schimbare furtune flexibile/ BR: Substituição das mangueiras/ EN: Replacing the hoses

5

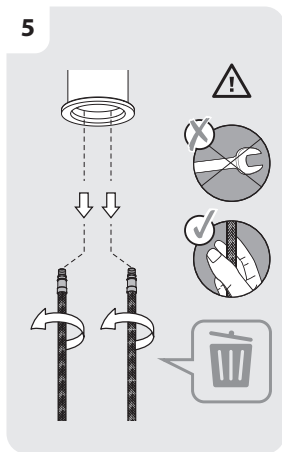

6

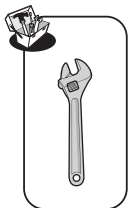
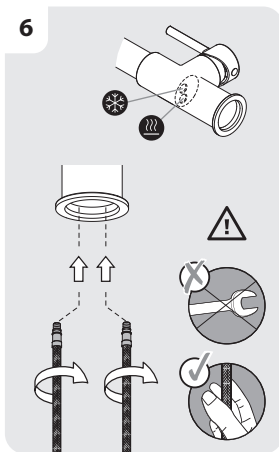

7

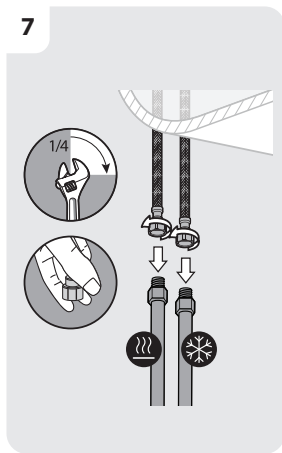

8

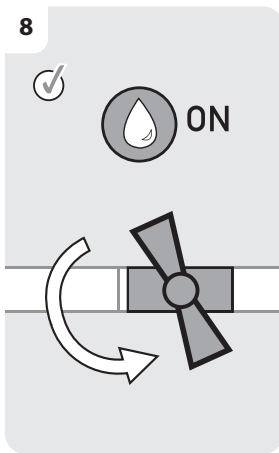



Eau claire / Agua limpia / Água limpa / Acqua pulita / Каваро веро / Czysta woda / Чистая вода / Sem solventes /  
Чиста вода / Арă curată / Água limpa / Clean water



Sans solvant / Sin disolvente / Sem solventes / Senza solventi / Хуриç диалутикă / Bez rozpuszczalnika / Без растворителя /  
еріткішçіç / Без розчинника / Fără solvent / таза су / Solvent-free

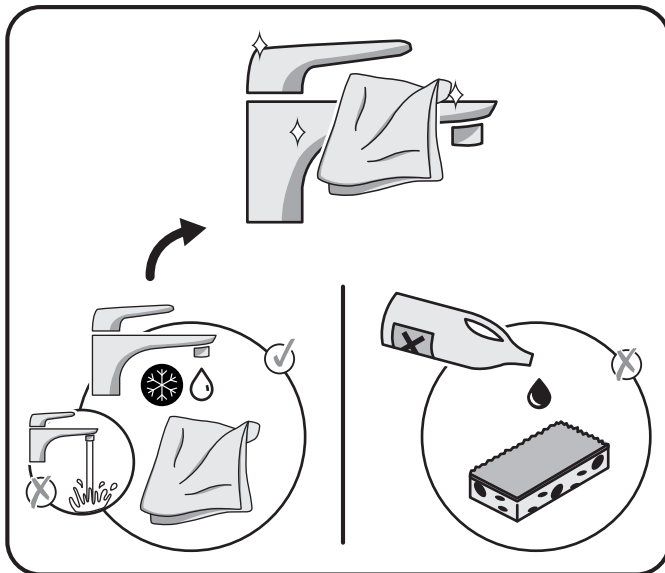

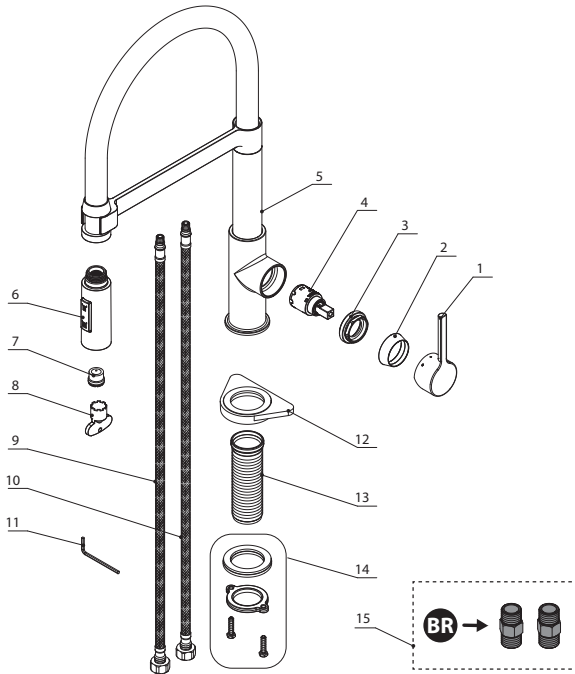

NO.	Description	Code No.	QTY	Remark
1	Handle	A662A78	1	
2	Beautifying cover	A508032	1	
3	Compressing nut	A104377	1	
4	Cartridge	SN-25 S/D COLD MIRROR	1	
5	Body spout assembly	312009-53-AX	1	
6	Shower head	LK2180-10(568005N-50)	1	
7	Aerator	44.2300.010	1	
8	Aerator key	09.9150.0	1	
9	Inlet hose (H)	TAQ-PEX-DN6-ACB H3/8-M8X1 L12 550-R-QB	1	
10	Inlet hose (C)	TAQ-PEX-DN6-ACB H3/8-M8X1 L12 550-QB	1	
11	L- wrench	A031000NI	1	
12	Plastic triangle	A663B13	1	
13	Easy fix shank	A228167	1	
14	Fixing kit	A663B16	1	
15	Connectors	A668322	1	





- FR** La présence sur ce robinet d'un ou plusieurs clapet(s) anti-retour est nécessaire au bon fonctionnement de l'ensemble de votre installation en eau. Ne tentez pas de le(s) retirer.
- ES** La presencia en este grifo de una o de varias válvula(s) de retención es necesaria para el buen funcionamiento del conjunto de su instalación de agua. No intente retirarla(s).
- PT** A presença nesta torneira de uma ou mais válvula(s) de retenção é necessária para o funcionamento adequado de toda a instalação de água. Não tente removê-la(s).
- IT** La presenza su questo rubinetto di una o più valvole anti riflusso è necessaria per il buon funzionamento della totalità del vostro impianto in acqua. Non tentare di rimuoverle.
- PL** Obecność jednego lub więcej zaworów zwrotnych kranu jest niezbędną dla prawidłowego funkcjonowania całej instalacji wodnej. Nie należy ich usuwać.
- EL** Η παρουσία σε αυτήν την μπαταρία, μιας ή περισσότερων, βαλβίδων αντεπιστροφής είναι απαραίτητη για την καλή λειτουργία του συνόλου της υδραυλικής σας εγκατάστασης. Μην επιχειρήσετε να τις αποσπώσετε.
- RU** Наличие на этом кране одного или нескольких обратных клапанов необходимо для правильной работы всей водопроводной установки. Не пытайтесь его/их снимать.
- KZ** Бул шүмектегі бір немесе бірнеше қайырмалы қапқақшының болуы түгел су құбыры қондырғысының дұрыс жұмыс жасауы үшін қажет. Оны/оларды алып тастауға тырыспаңыз.
- UA** Наявність на цьому крані одного або декількох зворотних клапанів необхідна для правильної роботи всієї водопровідної установки. Не намагайтеся його/їх зняти.
- RO** Prezența pe această robinet a uneia sau mai multor supape de reținere este necesară pentru buna funcționare a întregii dvs. instalații de apă. Nu încercați să le eliminați.
- BR** A presença de uma ou mais válvula(s) anti-retorno nessa torneira é necessária para o funcionamento adequado da sua instalação de água. Não tente remover a(s) válvula(s).
- EN** The presence of one or more anti-return valve(s) on this tap is required for proper operation of your water setup. Please do not attempt to remove it/them.



Certificado de conformidade sanitaria.  
 Atestado de conformidade sanitária.  
 certificato di conformità sanitaria.  
 Βεβαίωση υγειονομικής συμμόρφωσης.  
 Certyfikat zgodności sanitarnej.  
 Декларация о соответствии санитарным нормам  
 Санитарлық талаптарға сәйкестік декларациясы  
 Декларация про відповідність санітарним нормам  
 Atestat de conformitate sanitară  
 Certificado de conformidade sanitária.  
 Declaration of sanitary conformity.  
 Attestation de conformité sanitaire



\* Garantie 10 ans / 10 años de garantía / Garantia de 10 anos / Garanzia 10 Anni / Εγγύηση 10 ετών / Gwarancja 10-letnia / Гарантия 10 года / Келісімдік 10 жыл / Гарантія 10 років / Garantie 10 ani / 10 años de garantía / 10-year guarantee

Made in P.R.C. 2018

ADEO Services - 135 Rue Sadi Carnot - CS 00001  
 59790 RONCHIN - France

**UA** ТОВ «Леруа Мерлен Україна»,  
 вул. Полірна 17а, м. Київ 04201, Україна

