

# KIT GALANDAGE UNIQUE 100 LARGEUR 73 CM + AMORTISSEUR BIAS

VERSION PLAQUE DE PLÂTRE  
700 X 2030 MM

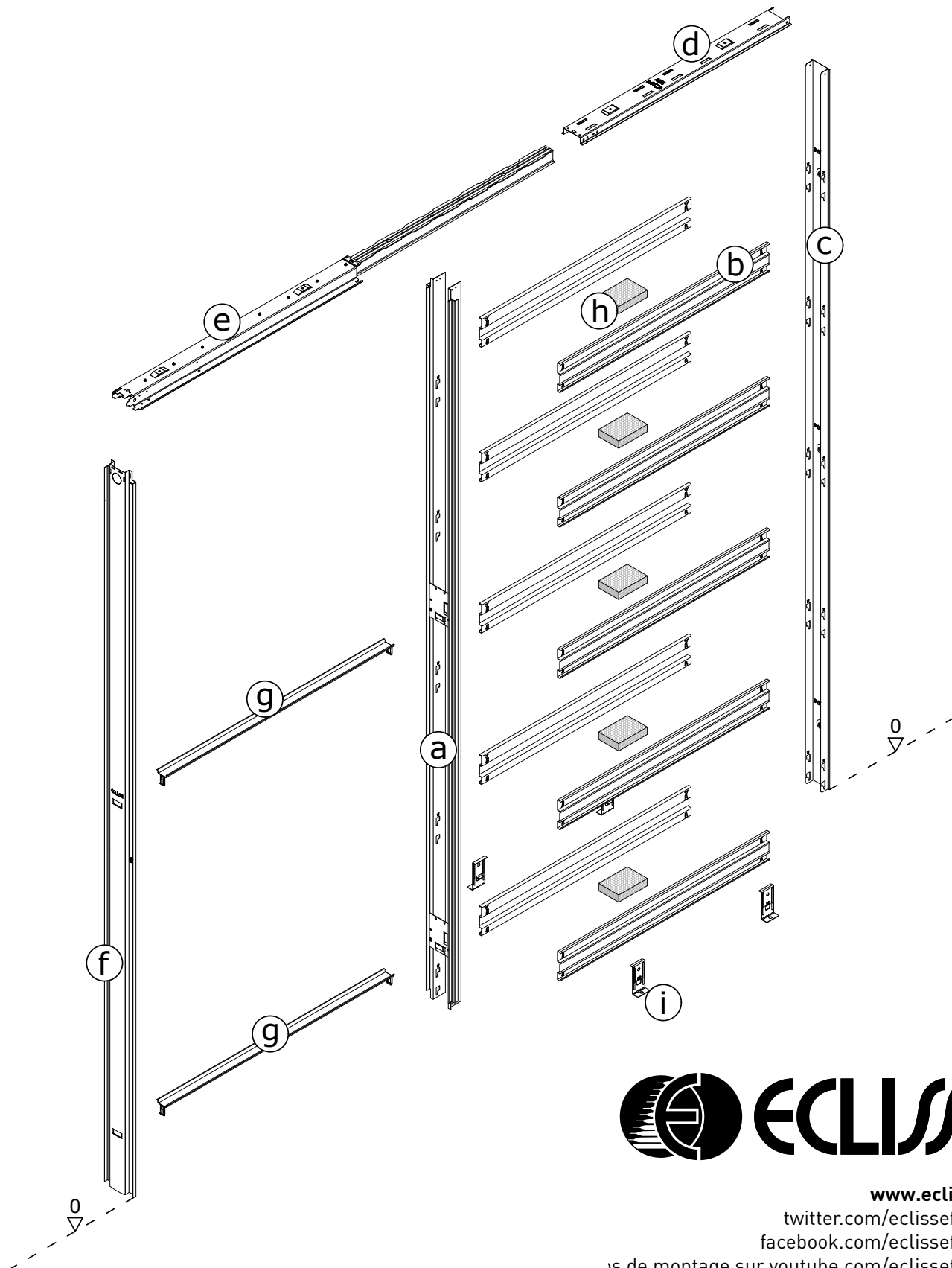

[www.eclisse.fr](http://www.eclisse.fr)  
[twitter.com/eclissefrance](https://twitter.com/eclissefrance)  
[facebook.com/eclissefrance](https://facebook.com/eclissefrance)  
vidéos de montage sur [youtube.com/eclissefrance](https://youtube.com/eclissefrance)  
©Eclisse.2019-v1  
Page 1/3

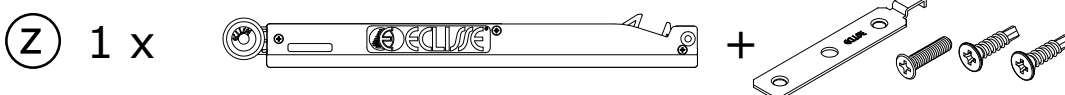
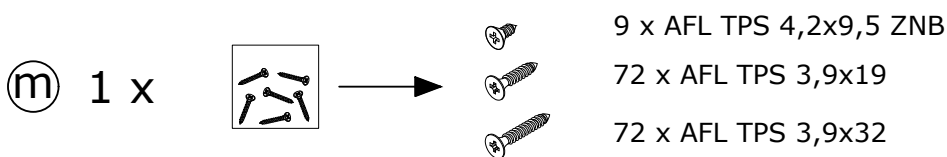
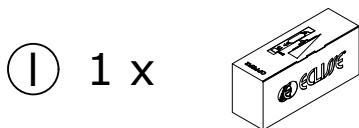
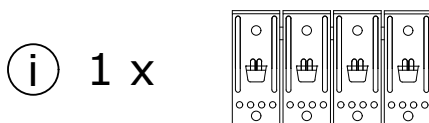
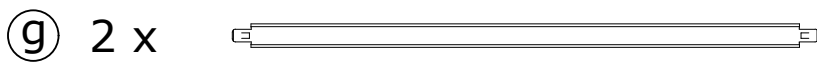
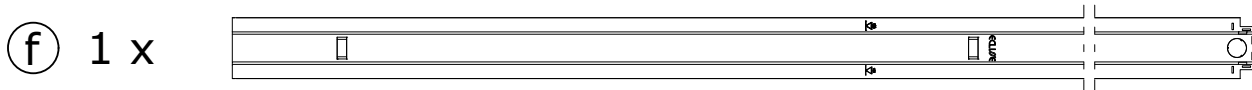
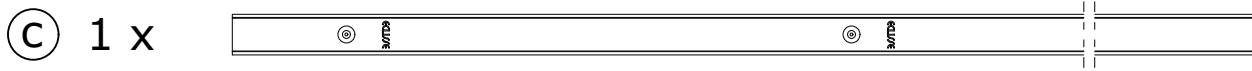
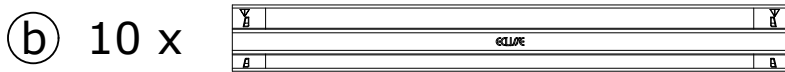
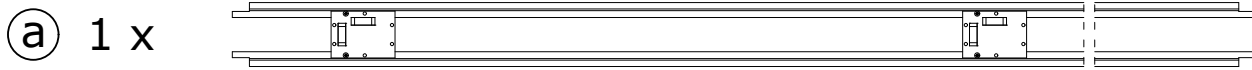

	Référence	Désignation	Quantité
a	310015400	Montant de passage	1
b	211025300	Profils Omega à insérer	10
c	207026900	Montant de fond de coffre	1
d	208058600	Porte-rail coffre	1
e+g	303003701	Porte-rail passage + rail + 2 entretoises de passage + 1 butée	1
f	200002601	Montant de butée	1
i	122032300	Équerres de fixation au sol	4
l	OPFER78	Boîte d'accessoires (notice, chariots, suspentes, guide au sol, butée, etc.)	1
m	OPFER19	Vis d'assemblage 4,2 x 9,5 / 3,9 x 19 / 3,9 x 32	1
z	BIAS	Amortisseur de fermeture BIAS	1