

COME INSTALLARE I BASTONI PER LE TENDE

HOW TO INSTALL CURTAIN RODS

COMMENT INSTALLER DES TRINGLES

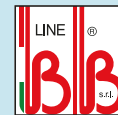

Tools · Outils

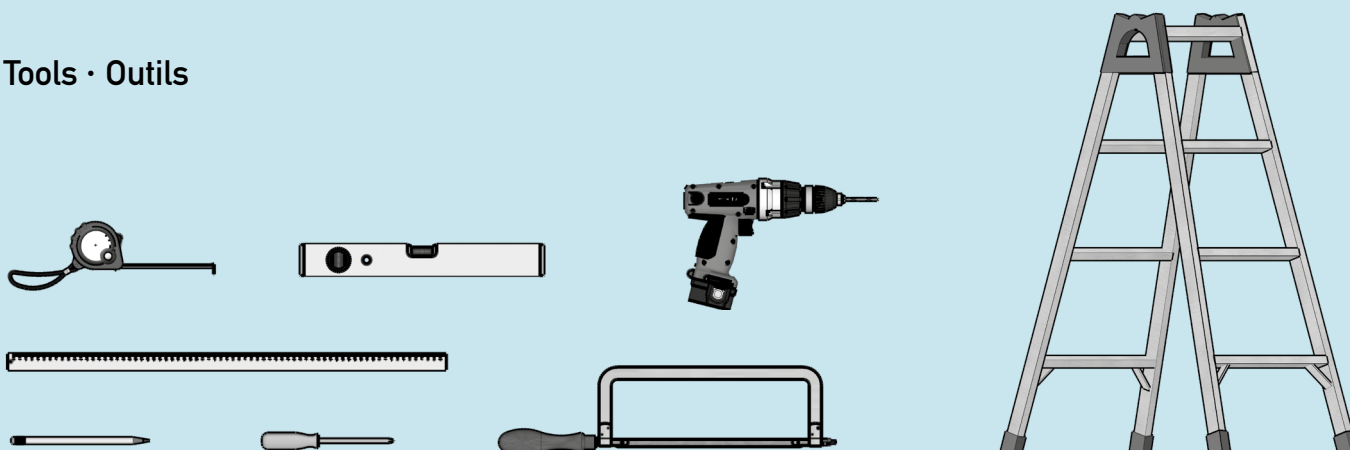

a)

ALLA PARETE
TO THE WALL
AU MUR

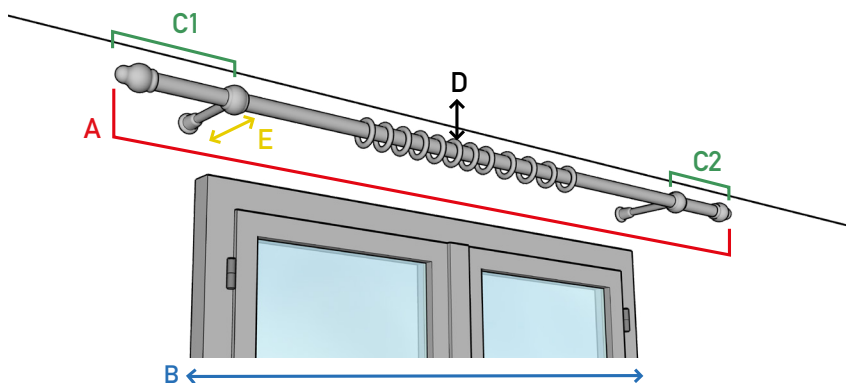

$$A = B + C1 + C2$$

$$C1 = 15/20 \text{ cm}$$

$$C2 = 15/20 \text{ cm}$$

$$D \geq 5 \text{ cm}$$

$$E = 10/15 \text{ cm}$$

b)

AL SOFFITTO
TO THE CEILING
DANS LE PLAFOND

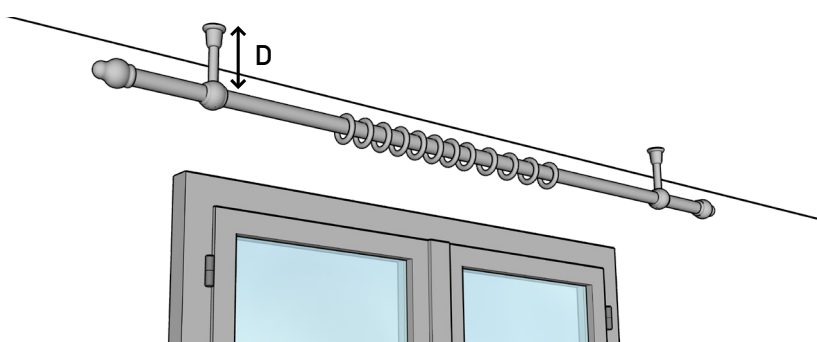

$$D \geq 5 \text{ cm}$$

c)

TRA DUE MURI
BETWEEN TWO WALLS
ENTRE DEUX MURS

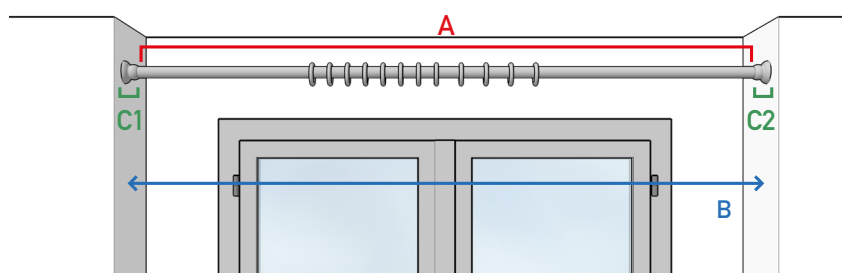

$$A = B - (C1 + C2)$$

1)

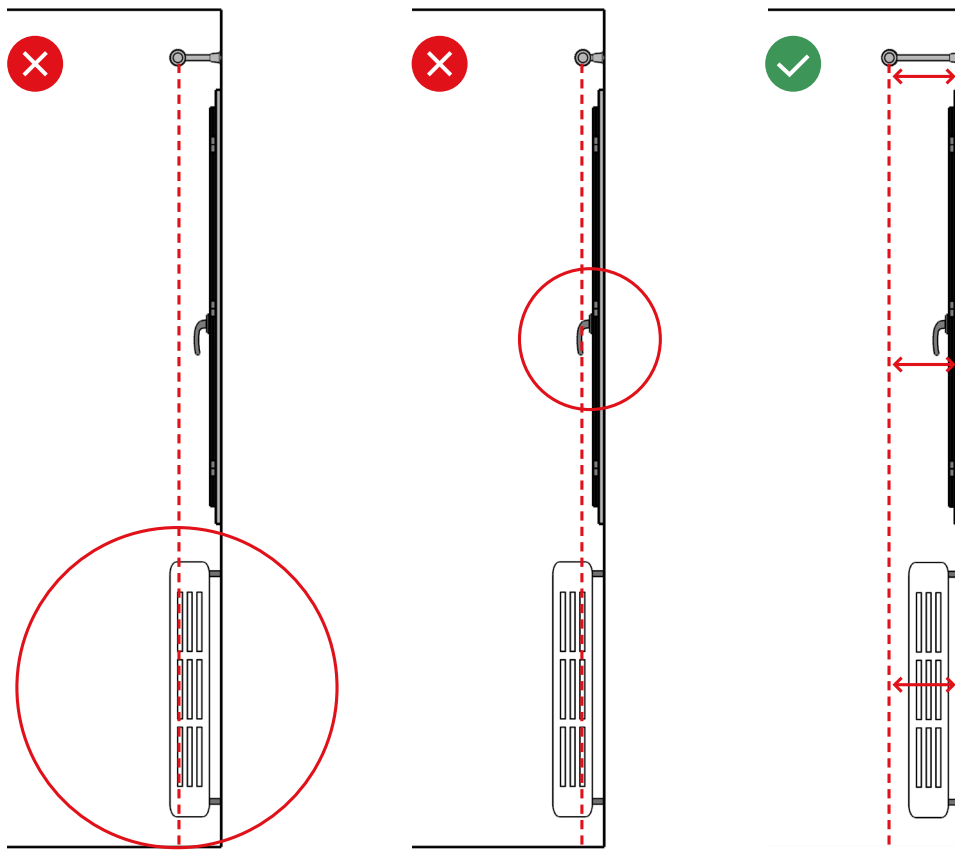

2)

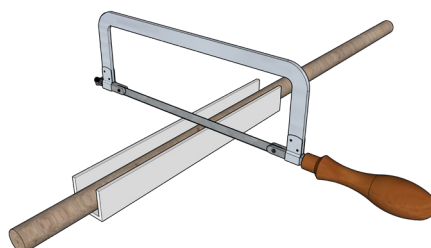
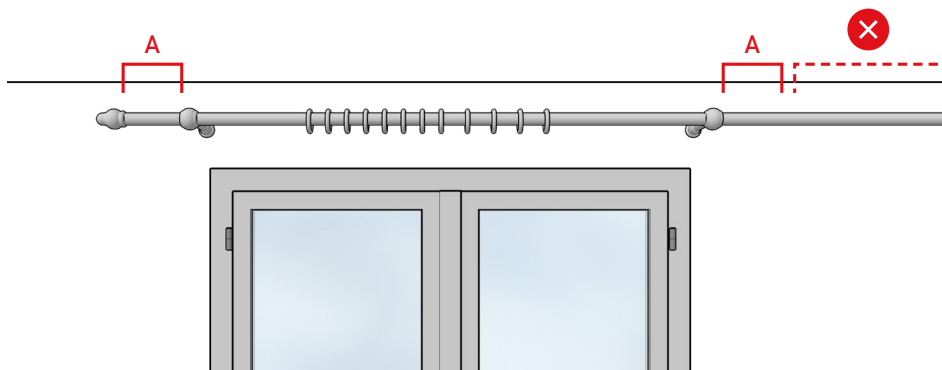

1)

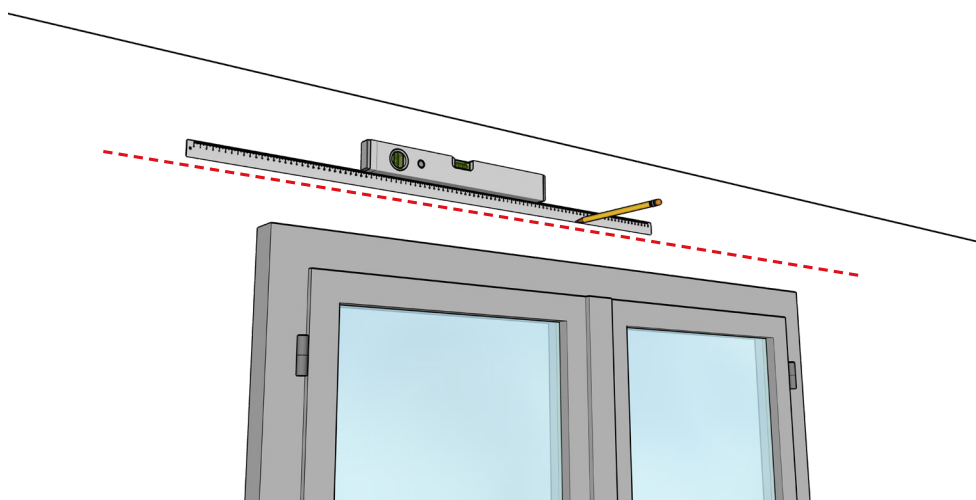

2)

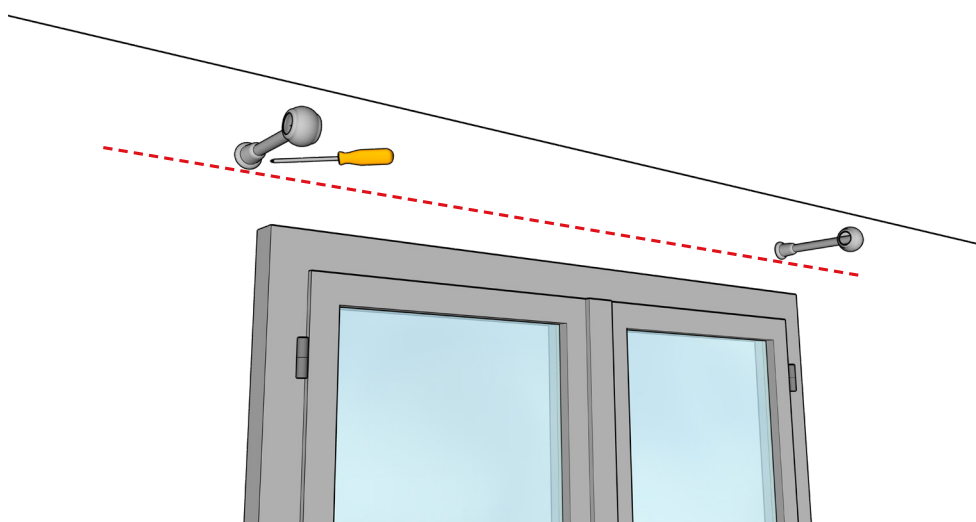

3)

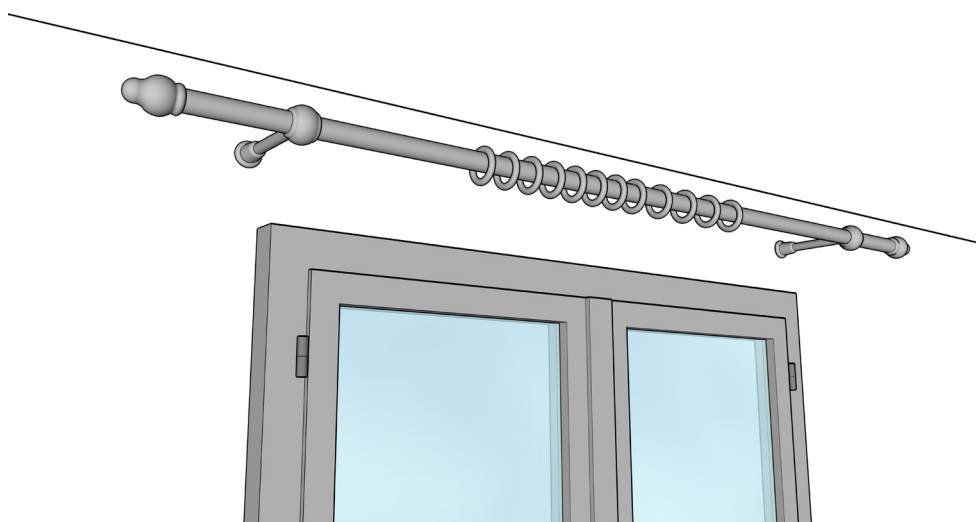

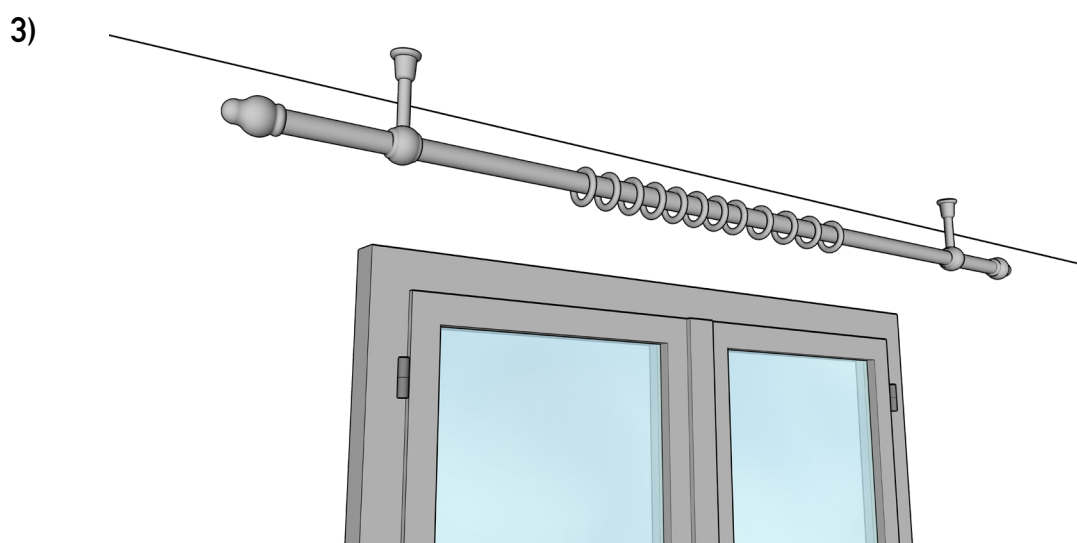
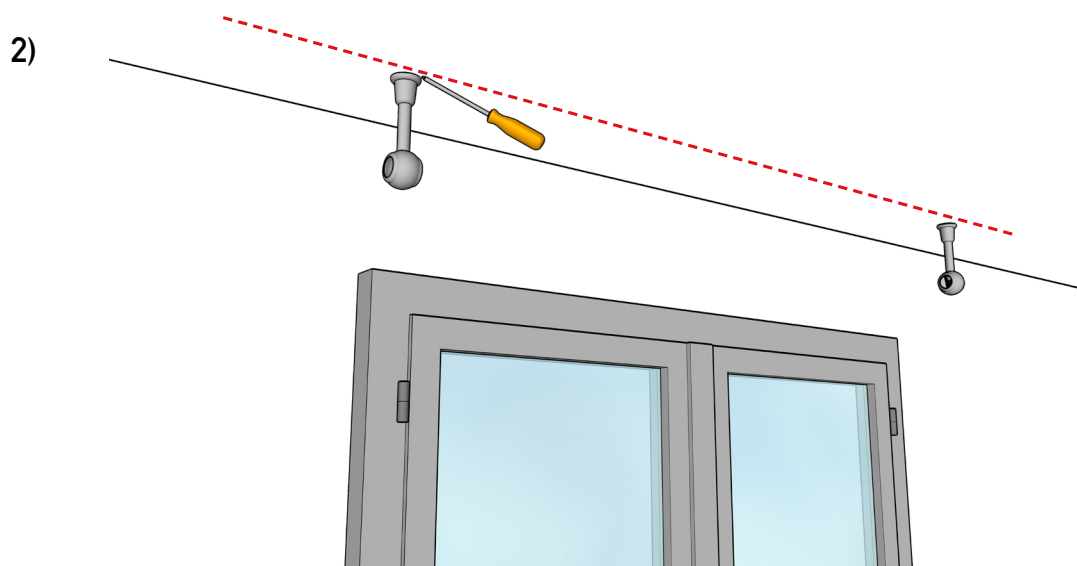
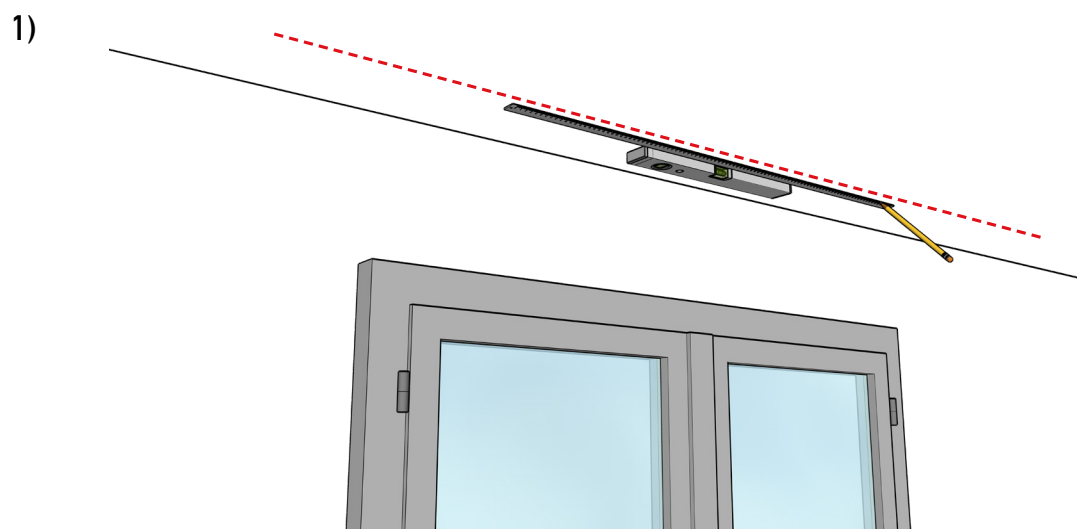

1)

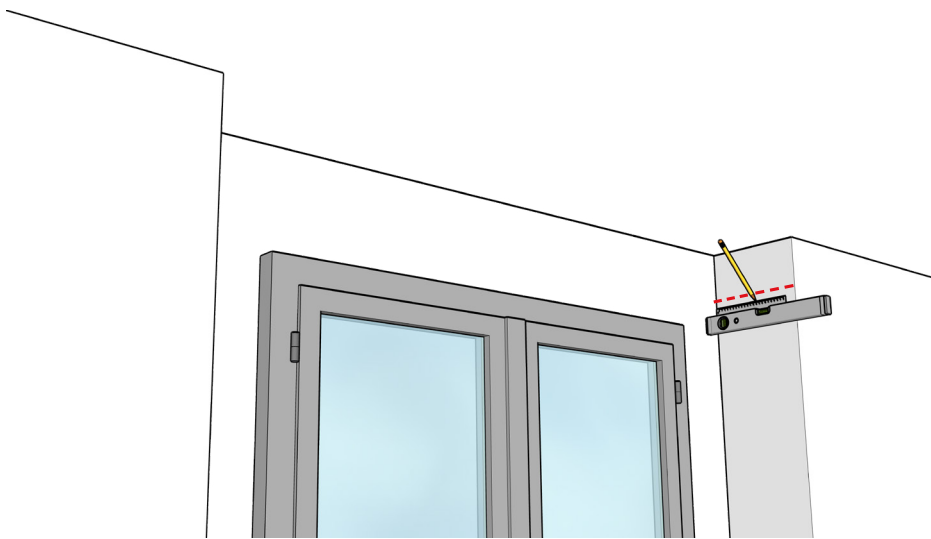

2)

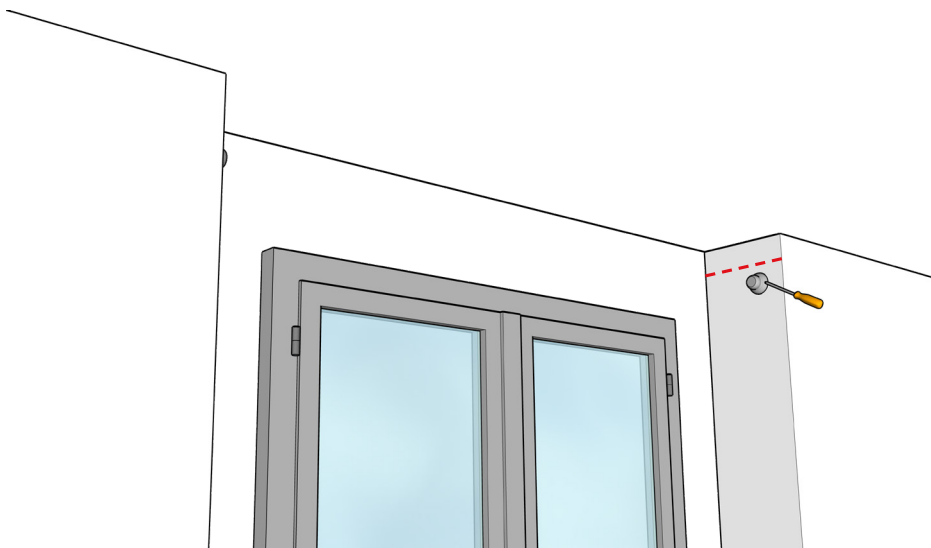

3)

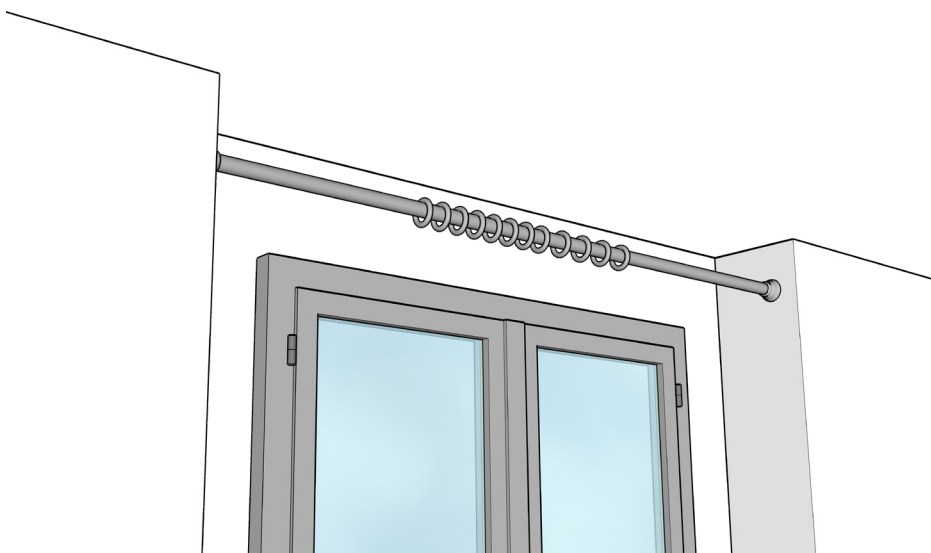

a)

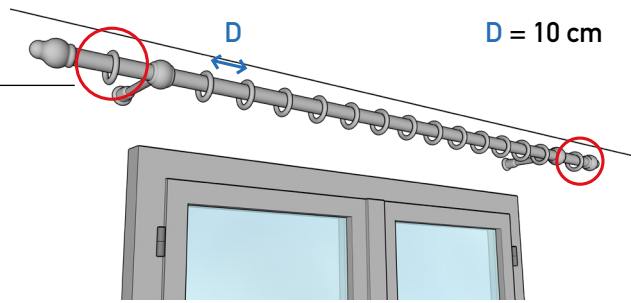
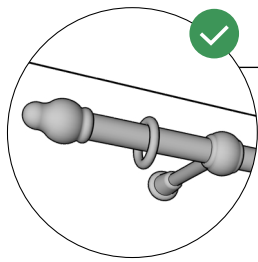

b)

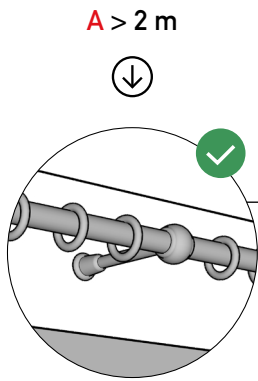

A > 2 m

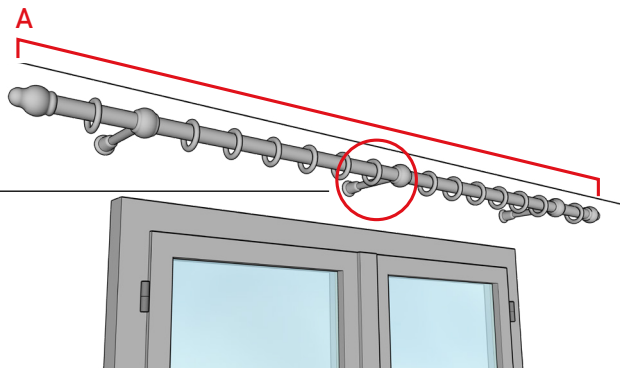

c)

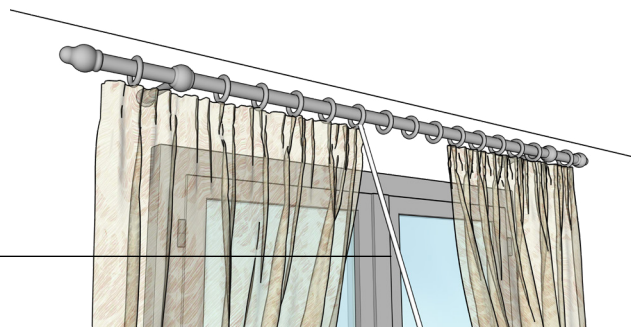
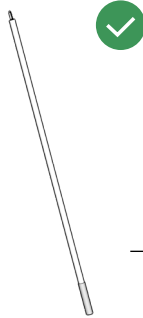

Le calamite fermatenda · Curtain magnetic clips · Embrasses magnétique

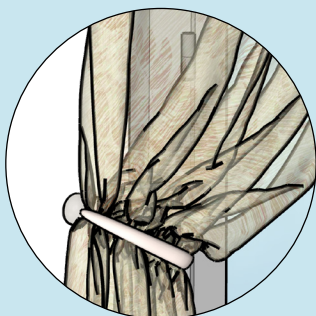

Come usare le calamite Ferma Tenda:

How to use curtain magnetic clips:

Comment utiliser les embrasses magnétique:



OR



CLICK HERE

Dima · Curtain Jig · Gabarit

Dima è lo strumento pensato per **semplificare il montaggio delle riloghe, evitando l'uso del metro e della livella**. Facile da usare, permette di installare le tende in pochi minuti e con pochi strumenti. **In più è ecogreen!**

Curtain Jig is a tool designed to **simplify the installation of curtain rods, avoiding the need for measuring tapes and spirit levels**. Easy to use, it allows you to put up curtains in a few minutes with minimal tools. **It's also EcoGreen!**

Gabarit est l'outil qui **semplicie le montage des tringles sans mètre et sans niveau**. Facile à utiliser, il permet d'installer les rideaux en quelques minutes et avec peu d'instruments. **Et is est écologique!**



ALLA PARETE · TO THE WALL · AU MUR

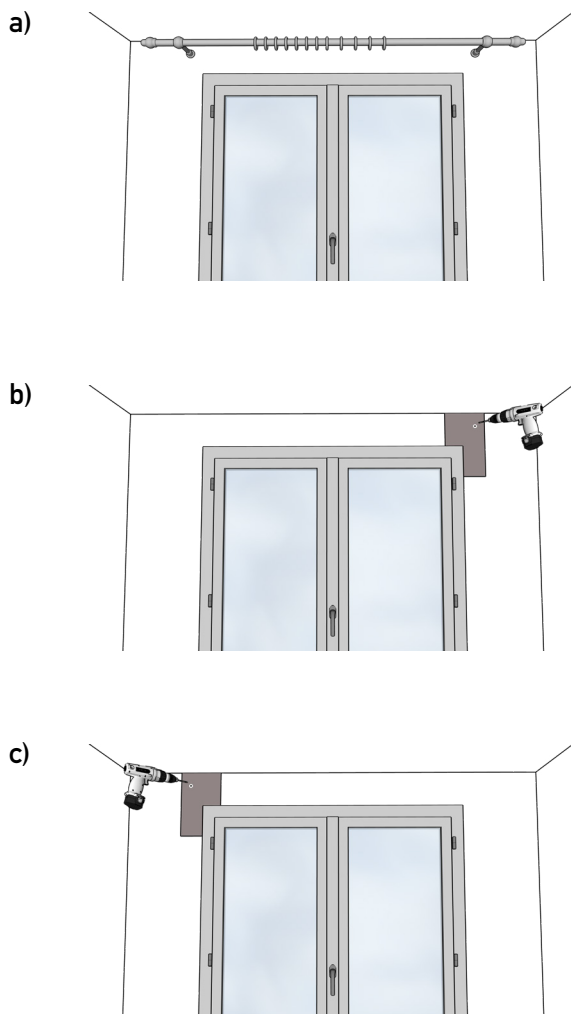

AL SOFFITTO · TO THE CEILING · DANS LE PLAFOND

