

Haier

ATW Service Manual



CONTENTS

1. Outdoor Units Lineup	1
2. Nomenclature	3
3. Feature	4
4. Description Of Main Components	5
5. Specifications	8
6. Dimensions	18
7. Piping Diagram	21
8. Wiring Diagram	26
9. Electric Characteristics	29
10. Capacity Tables	30
11. Operation Limits Delivery-Leaving	38
12. Water Pressure Drop	42
13. Sound Level	44
14. Installation	45
15. PCB Photo	77
16. Dip Switch Setting	79
17. Digital Tube Display	81
18. Startup & Running & Maintenance	83
19. Error Code	86
20. Troubleshooting	87
21. Sensor Resistance Table	114
22. YR-E27 YR-E27A	123
23. ATW-A01	134
24. Appendix	150

1. Outdoor Units Lineup



Model	Power Supply (V/Ph/Hz)	Capacity	Compressor type	Heat exchanger	A/C mode	Hydraulic module	Refrigerant
AU052FYCRA(HW) AU052FYCRB(HW)	220-240/1 /50/60	5kW	DC Inverter	Plate-heat exchanger	Heat pump	Built-in	R32



Model	Power Supply (V/Ph/Hz)	Capacity	Compressor type	Heat exchanger	A/C mode	Hydraulic module	Refrigerant
AU082FYCRA(HW)	220-240/1 /50/60	8kW	DC Inverter	Coaxial	Heat pump	Built-in	R32



Model	Power Supply (V/Ph/Hz)	Capacity	Compressor type	Heat exchanger	A/C mode	Hydraulic module	Refrigerant
AU112FYCRA(HW)	220-240/1/50/60	11kW	DC Inverter	Tubes in shell	Heat pump	Built-in	R32
AU162FYCRA(HW)	220-240/1/50/60	16kW	DC Inverter		Heat pump	Built-in	R32

2. Nomenclature

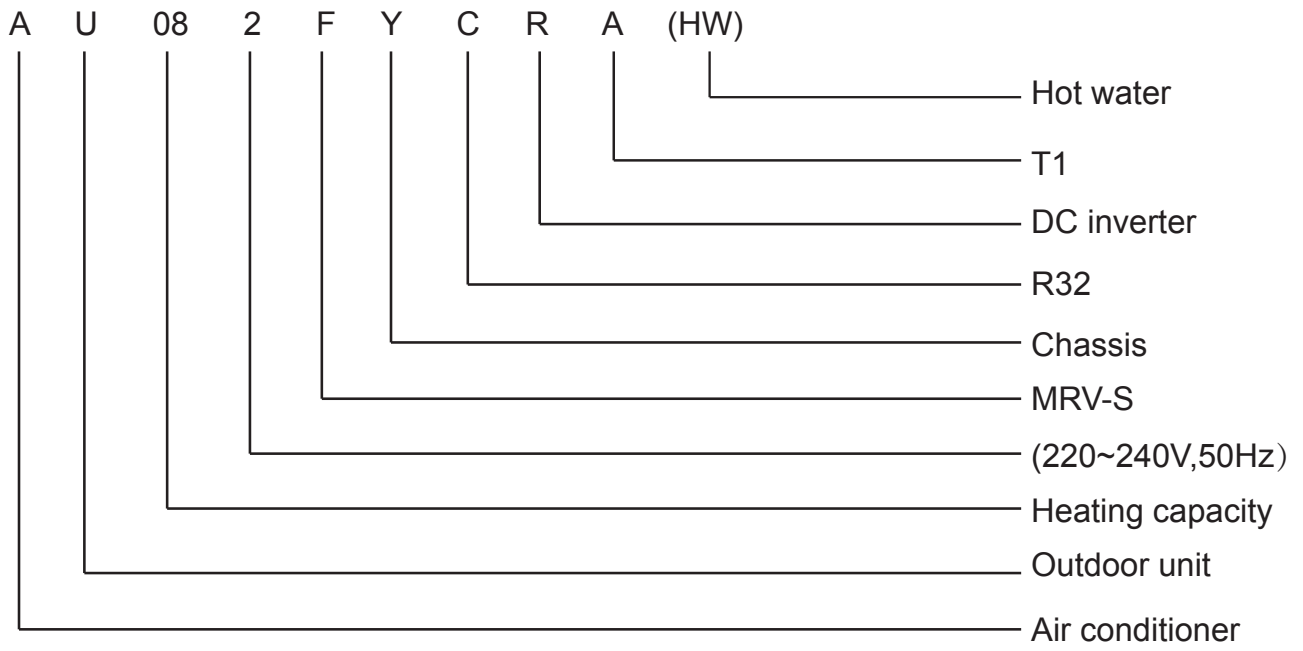

3. Feature

3.1 Monobloc Air-to-Water Heat pump System

Full DC inverter mini Heat pump adopts highly intelligent inverter-driven compressor. This advanced technology enables the output of the outdoor unit to be modulated by the real heat load demands..

This advanced system ensures precise temperature regulation and highly efficient energy usage, making a significant contribution to limiting the impact on the environment.

3.2 High performance heat exchanger

Hydrophilic film fins and inner-threaded copper pipes optimize heat exchange efficiency.

3.3 Low-operating sound design

Optimally design fan shape and new designed discharge air grille and air deflector, making higher air volume and lower operation sound.

3.4 Wide operation temperature range

Stable and safe running in wide ambient temperature range, cooling performance from 10 °C to 46°C, heating from -20°C to 35°C.

3.5 Energy saving and high reliability

By adopting high efficiency Coaxial heat exchanger or tubes in shell heater exchanger or plate-heat exchanger , the energy consumption can be reduced.



Built-in with voltage protection, current protection, anti-freezing protection, water flow protection and etc., effectively guarantee the system to work safely.

3.6 Flexible and convenient control

Compact devices with advanced function and friendly user interface.

The Heat pump can be controlled by optional wired controller (YR-E27) ,

3.7 Integrated and compact design

Fully integrated and built-in hydraulic module, such as Coaxial heat exchanger or tubes in shell heater exchanger, water circulating pump, the water pressure difference switch, etc. It saves installation space and cost.

3.8 EXV control flow more precisely

Stable and accurate gas flow control. EXV achieves 500 pulses to adjust flow precisely. Ensure the temperature-control precisely and steadily to provide a comfortable environment.

Fast respond resulting in higher efficiency and improved reliability.

3.9 Water pump starts/stops compulsory function

Press the key "Set" of YR-E27 for 15 seconds to start the water pump operating when the unit is standby. Press "Set" key for 15 seconds again to stop the water pump.

4. Description Of Main Components

Structure

Panels and base are made from galvanized steel plate painted with epoxy power to ensure total resistance to atmospheric pollution, condensate collection pan as standard.

Air cooled coils:

The coils are made from high performance and seamless copper tuber and high surface area aluminum fins to ensure optimum heat exchange capability. Condenser coil protection grill is standard.

Fan motor:

To achieve high efficiency heat exchange, the unit is equipment with the high performance axial-flow fans. The fan is driven directly by weather proof motor to ensure reliable operation, the fan motor is six-pole electric motor with built-in thermal cut-out.

Hydraulic module:

It is fully integrated and equipped with key hydraulic components such as Coaxial heat exchanger (applied for AU082) and tubes in shell heater exchanger (applied for AU112/162), plate-heat exchanger (applied for AU052). water circulating pump. The water pressure difference switch is provided in the units to protect against damage to the water pump.

Power and control electrical panel

Power and control electrical panel constructed in accordance with IEC 204-1/EN60335-2-40, complete with compressor contactor, control via control panel.

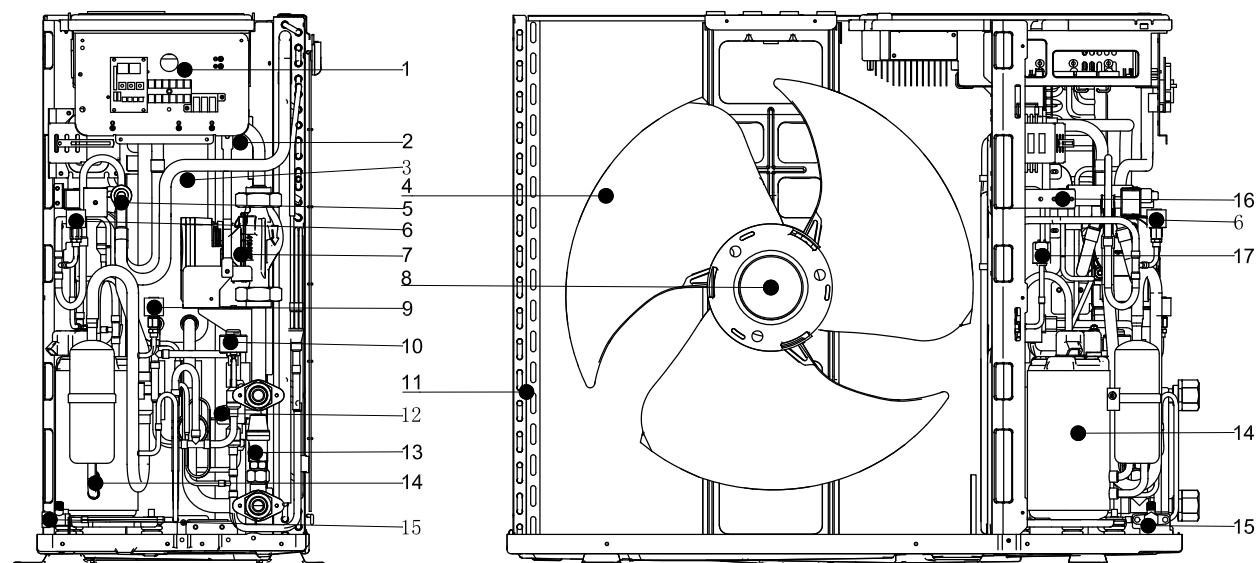

- 1. Electrical panel
- 3. Plate-heat exchanger
- 5. 4-Way valve
- 7. Pump
- 9. Low pressure sensor
- 11. Condenser
- 13. Safety valve
- 15. Refrigerant charge valve
- 17. High pressure switch

- 2. Liquid receiver
- 4. Axial-flow fan
- 6. High pressure sensor
- 8. Fan motor
- 10. Electronic expansion valve
- 12. Pressure switch
- 14. Compressor
- 16. Solenoid valve

AU052FYCRA (HW)
AU052FYCRB (HW)

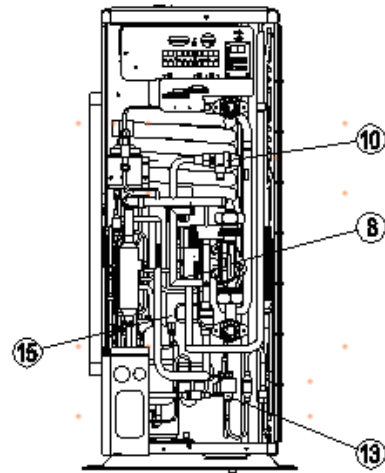
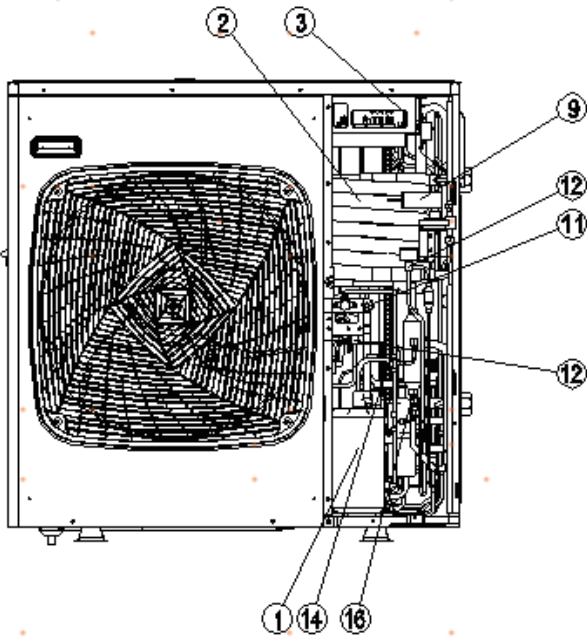
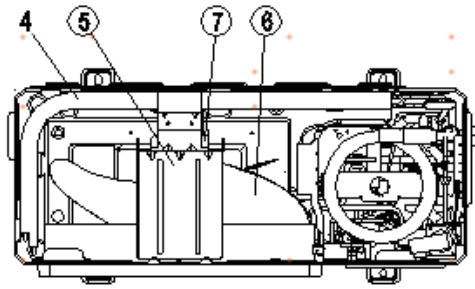

AU082FYCRA (HW)

- 1.Compressor
- 3.Electrical panel
- 5.Motor bracket
- 7.Motor
- 9.Pressure Difference switch
- 11.4-way valve
- 13.Electronic expansion valve
- 15.Low pressure sensor

- 2.Coaxial heat exchanger
- 4.Condenser
- 6.Axial-flow fan
- 8.Water Pump
- 10.Safety valve
- 12.Solenoid valve
- 14.High pressure switch
- 16.High pressure sensor

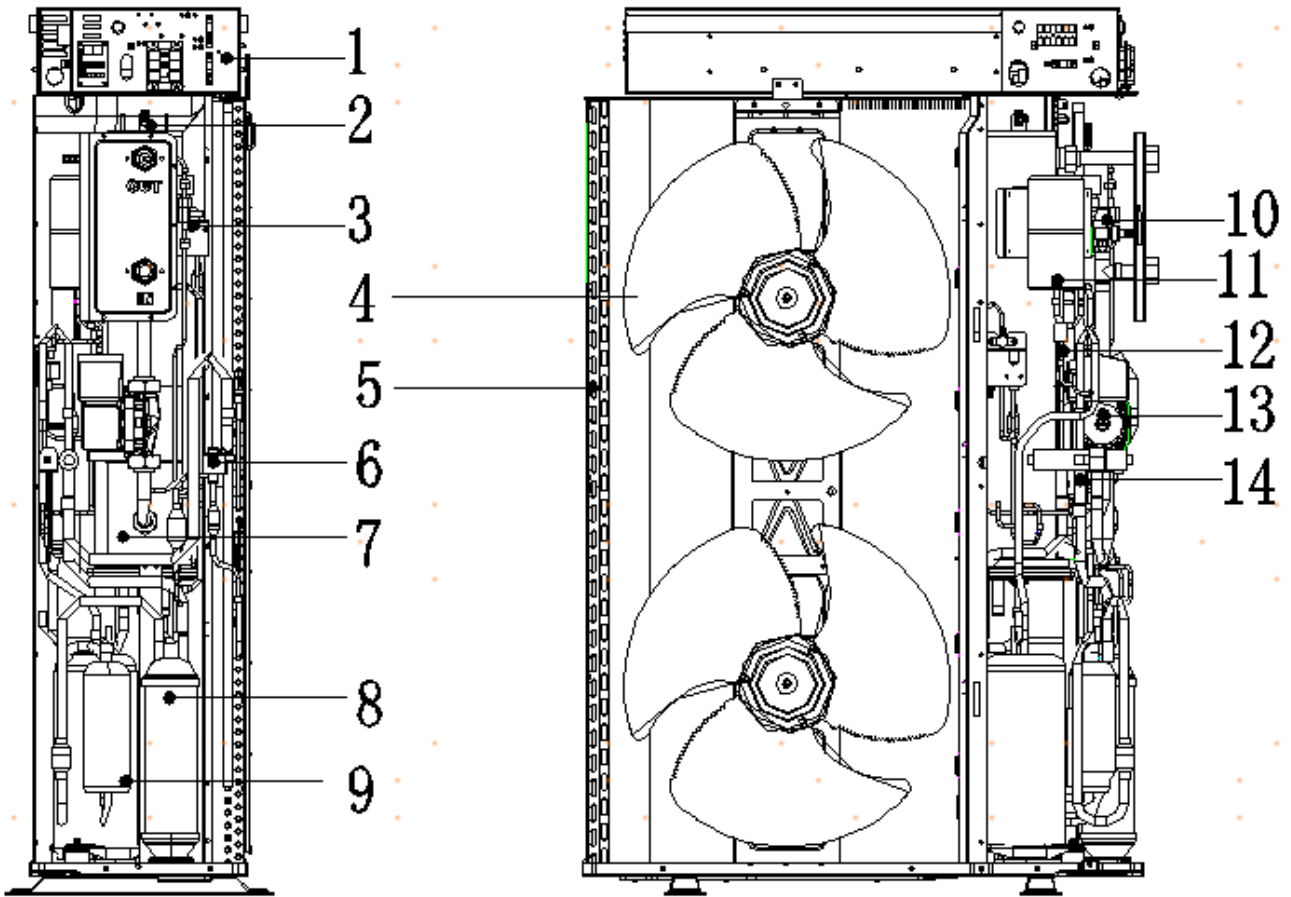

AU112/162 FYCRA (HW)

- | | |
|----------------------------------|-------------------------------|
| 1. Electrical panel | 2. Discharge valve |
| 3. Differential pressure switch | 4. Axial-flow fan |
| 5. Condenser | 6. Electronic expansion valve |
| 7. Shell-and-tube heat exchanger | 8. Accumulator |
| 9. Compressor | 10. Safety valve |
| 11. Buffer tank | 12. High pressure switch |
| 13. Pump | 14. 4-Way valve |

5. Specifications

Model		AU052FYCRA(HW)	
Power supply		V-Ph-Hz	1PH, 220-240V~, 50/60Hz
Cooling*(1)	Capacity	kW	5.00
	Input	kW	1.56
Cooling*(2)	Capacity	kW	5.00
	Input	kW	1.00
Heating*(3)	Capacity	kW	5.00
	Input	kW	1.64
Heating*(4)	Capacity	kW	5.00
	Input	kW	0.99
EER*(1)		kW/kW	3.20
EER*(2)		kW/kW	5.00
COP*(3)			3.05
COP*(4)			5.05
Max.input consumption		kW	3.10
Max.input current		A	13.5
Compressor	Model		SVB172FNQMC-L2
	Type		ROTARY
	Brand		Mitsubishi Electric
	Capacity	kW	5.43
	Input	kW	1.77
	Rated load current	A	6.0
	Locked rotor Amp	A	20
	Thermal protector		Inner
	Refrigerant oil type,charge		FW68S, 350
Outdoor fan motor	Model		SIC-71FW-F190-2
	Type		DC Motor
	Brand		NIDEC SHIBAURA
	Input	kW	90
	Speed	r/min	160-850
Outdoor coil	Number of rows		2
	Tube pitch(a)× row pitch(b)	mm	21*18.186
	Fin spacing	mm	1.4
	Fin type		Hydrophilic aluminum foil
	Tube outside dia. and type	mm	φ7
	Coil length ×height	mm	1005*714
	Number of circuits		6

Model			AU052FYCRA(HW)
Water pump	Type		Para 25/8-75/SC-WILO
	Input (H/M/L)	W	75/57/35
	Pumping head	m	8
Outdoor air flow		m ³ /h	2200
Throttle			EXV
Outdoor noise level (sound power)*(3)		dB(A)	61
Flow rate of water		L/h	14.3
The water pressure drop of heat-exchanger		kPa	20
The Max. and Min. water inlet pressure		kPa	500/150
Outdoor unit	Net dimension (W×H×D)	mm	760×920×372
	Packing dimension(W×H×D)	mm	875×1045×488
	Net/ Gross weight	kg	69/80
Refrigerant	Type		R32
	Charged volume	kg	1.00
Connection wiring	Power wire	mm ²	3×6.0
Pipe diameter	Water inlet/outlet	inch	Rc3/4
Controller			Wired controller
Ambient temperature range			Cooling:10~46°C Heating:-25~35°C (Antifreeze must be added below 5)
Leaving water temperature range			Cooling: 5~20°C Heating: 25~60 °C
Accessory	Wired Controller		YR-E27A
	Domestic hot water PCB		ATW-A01
<p>Note: Specifications are based on the following conditions:</p> <p>1. Cooling: (*1) Entering/leaving water temperature: 12/7°C, outdoor ambient temperature 35°C DB. (*2) Entering/leaving water temperature: 23/18°C, outdoor ambient temperature 35°C DB.</p> <p>2. Heating: (*3) Entering/leaving water temperature: 40/45°C, outdoor ambient temperature 7°C DB/6°C WB . (*4) Entering/leaving water temperature: 30/35°C, outdoor ambient temperature 7°C DB/6°C WB .</p> <p>3. It is tested in a semi-anechoic room (sound power).</p> <p>4. The above data may be changed without notice for future improvement on quality and performance.</p>			

Model		AU052FYCRB(HW)	
Power supply		V-Ph-Hz	1PH, 220-240V~, 50/60Hz
Cooling*(1)	Capacity	kW	5.00
	Input	kW	1.56
Cooling*(2)	Capacity	kW	5.00
	Input	kW	1.00
Heating*(3)	Capacity	kW	5.00
	Input	kW	1.64
Heating*(4)	Capacity	kW	5.00
	Input	kW	0.99
EER*(1)		kW/kW	3.20
EER*(2)		kW/kW	5.00
COP*(3)			3.05
COP*(4)			5.05
Max.input consumption		kW	3.10
Max.input current		A	13.5
Compressor	Model		SVB172FNQMC-L2
	Type		ROTARY
	Brand		Mitsubishi Electric
	Capacity	kW	5.43
	Input	kW	1.77
	Rated load current	A	6.0
	Locked rotor Amp	A	20
	Thermal protector		Inner
	Refrigerant oil type,charge		FW68S, 350
Outdoor fan motor	Model		SIC-71FW-F190-2
	Type		DC Motor
	Brand		NIDEC SHIBAURA
	Input	kW	90
	Speed	r/min	160-850
Outdoor coil	Number of rows		2
	Tube pitch(a)× row pitch(b)	mm	21*18.186
	Fin spacing	mm	1.4
	Fin type		Hydrophilic aluminum foil
	Tube outside dia. and type	mm	φ7
	Coil length ×height	mm	1005*714
	Number of circuits		6

Model			AU052FYCRB(HW)
Water pump	Type		Para 25/8-75/SC-WILO
	Input (H/M/L)	W	75/57/35
	Pumping head	m	8
Outdoor air flow		m ³ /h	2200
Throttle			EXV
Outdoor noise level (sound power)*(3)		dB(A)	61
Flow rate of water		m ³ /h	14.3
The water pressure drop of heat-exchanger		kPa	20
The Max. and Min. water inlet pressure		kPa	500/150
Outdoor unit	Net dimension (W×H×D)	mm	760×920×372
	Packing dimension(W×H×D)	mm	875×1045×488
	Net/ Gross weight	kg	69/80
Refrigerant	Type		R32
	Charged volume	kg	1.00
Connection wiring	Power wire	mm ²	3×6.0
Pipe diameter	Water inlet/outlet	inch	Rc3/4
Controller (optional)			Wired controller
Ambient temperature range			Cooling:10~46°C Heating:-25~35°C (Antifreeze must be added below 5)
Leaving water temperature range			Cooling: 5~20°C Heating: 25~60 °C
Accessory	Wired Controller		YR-E27A
	Domestic hot water PCB		ATW-A01
<p>Note: Specifications are based on the following conditions:</p> <p>1. Cooling: (*1) Entering/leaving water temperature: 12/7°C, outdoor ambient temperature 35°C DB. (*2) Entering/leaving water temperature: 23/18°C, outdoor ambient temperature 35°C DB.</p> <p>2. Heating: (*3) Entering/leaving water temperature: 40/45°C, outdoor ambient temperature 7°C DB/6°C WB . (*4) Entering/leaving water temperature: 30/35°C, outdoor ambient temperature 7°C DB/6°C WB .</p> <p>3. It is tested in a semi-anechoic room (sound power).</p> <p>4. The above data may be changed without notice for future improvement on quality and performance.</p>			

Model		AU082FYCRA(HW)	
Power supply		V-Ph-Hz	1PH, 220-240V~,50/60Hz
Cooling*(1)	Capacity	kW	5.50
	Input	kW	2.34
Cooling*(2)	Capacity	kW	7.00
	Input	kW	1.89
Heating*(3)	Capacity	kW	7.01
	Input	kW	2.76
Heating*(4)	Capacity	kW	7.80
	Input	kW	1.77
EER*(1)		kW/kW	2.35
EER*(2)		kW/kW	3.70
COP*(3)			2.54
COP*(4)			4.40
Max.input consumption		kW	4.90
Max.input current		A	21.3
Compressor	Model		SVB200FKMMC
	Type		ROTARY
	Brand		Mitsubishi Electric
	Capacity	kW	6.45
	Input	kW	2.15
	Rated load current	A	7.90
	Locked rotor Amp	A	24
	Thermal protector		Inner
	Refrigerant oil type,charge		FW68S,400
Outdoor fan motor	Model		SIC-88FWJ-F1180-1
	Type		DC Motor
	Brand		NIDEC SHIBAURA
	Input	kW	180
	Speed	r/min	160-850
Outdoor coil	Number of rows		2
	Tube pitch(a)× row pitch(b)	mm	21*18.186
	Fin spacing	mm	1.4
	Fin type		Hydrophilic aluminum foil
	Tube outside dia. and type	mm	φ7
	Coil length ×height	mm	1005*924
	Number of circuits		7

Model			AU082FYCRA(HW)
Water pump	Type		Para 25/8-75/SC-WILO
	Input (H/M/L)	W	75/57/35
	Pumping head	m	8
Outdoor air flow		m ³ /h	4200
Throttle			EXV
Outdoor noise level (sound power)*(3)		dB(A)	64
Flow rate of water		m ³ /h	1.38
The water pressure drop of heat-exchanger		kPa	45
The Max. and Min. water inlet pressure		kPa	500/150
Outdoor unit	Net dimension (W×H×D)	mm	970×950×370
	Packing dimension(W×H×D)	mm	1108×1010×480
	Net/ Gross weight	kg	87/97
Refrigerant	Type		R32
	Charged volume	kg	1.15
Connection wiring	Power wire	mm ²	3×10.0
Pipe diameter	Water inlet/outlet	inch	Rc1
Controller (optional)			Wired controller
Ambient temperature range			Cooling: 10~46°C Heating: -20~35°C(Antifreeze must be added below 5)
Leaving water temperature range			Cooling: 5~20°C Heating: 25~55°C
Accessory	Wired Controller		YR-E27
	Domestic hot water PCB		ATW-A01

Note: Specifications are based on the following conditions:

- Cooling: (*1) Entering/leaving water temperature: 12/7°C, outdoor ambient temperature 35°C DB.
(*2) Entering/leaving water temperature: 23/18°C, outdoor ambient temperature 35°C DB.
- Heating: (*3) Entering/leaving water temperature: 40/45°C, outdoor ambient temperature 7°C DB/6°C WB .
(*4) Entering/leaving water temperature: 30/35°C, outdoor ambient temperature 7°C DB/6°C WB .
- It is tested in a semi-anechoic room (sound power).
- The above data may be changed without notice for future improvement on quality and performance.

Model			AU112FYCRA(HW)
Power supply		V-Ph-Hz	1PH, 220-240V~,50/60Hz
Cooling*(1)	Capacity	kW	11.5
	Input	kW	3.83
Cooling*(2)	Capacity	kW	13.5
	Input	kW	2.94
Heating*(3)	Capacity	kW	9.99
	Input	kW	4.40
Heating*(4)	Capacity	kW	11.00
	Input	kW	2.61
EER*(1)		kW/kW	3.00
EER*(2)		kW/kW	4.60
COP*(3)			2.27
COP*(4)			4.22
Max.input consumption		kW	5.60
Max.input current		A	24.3
Compressor	Model		TVB306FKMMC
	Type		ROTARY
	Brand		Mitsubishi Electric
	Capacity	kW	10.27
	Input	kW	3.42
	Rated load current	A	9.87
	Locked rotor Amp	A	45.5
	Thermal protector		Inner
	Refrigerant oil type,charge		FW68S□870
Outdoor fan motor	Model		SIC-88FWJ-F1180-1
	Type		DC Motor
	Brand		NIDEC SHIBAURA
	Input	kW	180
	Speed	r/min	160-780
Outdoor coil	Number of rows		2
	Tube pitch(a)× row pitch(b)	mm	21*18.186
	Fin spacing	mm	1.4
	Fin type		Hydrophilic aluminum foil
	Tube outside dia. and type	mm	φ7
	Coil length ×height	mm	1005*1302
	Number of circuits		10

Model			AU112FYCRA(HW)
Water pump	Type		UPMXL GEO 25-125 130 PWM-Grundfos
	Input (H/M/L)	W	160/110/80
	Pumping head	m	12.5
Outdoor air flow		m ³ /h	7200
Throttle			EXV
Outdoor noise level (sound power)*(3)		dB(A)	67
Flow rate of water		m ³ /h	1.89
The water pressure drop of heat-exchanger		kPa	40
The Max. and Min. water inlet pressure		kPa	500/150
Outdoor unit	Net dimension (W×H×D)	mm	1500×950×370
	Packing dimension(W×H×D)	mm	1638×1010×480
	Net/ Gross weight	kg	145/157
Refrigerant	Type		R32
	Charged volume	kg	2.40
Connection wiring	Power wire	mm ²	3×10.0
Pipe diameter	Water inlet/outlet	inch	Rc1
Controller (optional)			Wired controller
Ambient temperature range			Cooling:10~46°C Heating: -20~35°C(Antifreeze must be added below 5)
Leaving water temperature range			Cooling: 5~20°C Heating: 25~55°C
Accessory	Wired Controller		YR-E27
	Domestic hot water PCB		ATW-A01
<p>Note: Specifications are based on the following conditions:</p> <ol style="list-style-type: none"> Cooling: (*1) Entering/leaving water temperature: 12/7°C, outdoor ambient temperature 35°C DB. (*2) Entering/leaving water temperature: 23/18°C, outdoor ambient temperature 35°C DB. Heating: (*3) Entering/leaving water temperature: 40/45°C, outdoor ambient temperature 7°C DB/6°C WB . (*4) Entering/leaving water temperature: 30/35°C, outdoor ambient temperature 7°C DB/6°C WB . It is tested in a semi-anechoic room (sound power). The above data may be changed without notice for future improvement on quality and performance. 			

Model		AU162FYCRA(HW)	
Power supply		V-Ph-Hz	1PH, 220-240V~,50/60Hz
Cooling*(1)	Capacity	kW	14.50
	Input	kW	4.92
Cooling*(2)	Capacity	kW	16.00
	Input	kW	3.64
Heating*(3)	Capacity	kW	14.01
	Input	kW	5.63
Heating*(4)	Capacity	kW	16.00
	Input	kW	3.86
EER*(1)		kW/kW	2.95
EER*(2)		kW/kW	4.40
COP*(3)			2.49
COP*(4)			4.15
Max.input consumption		kW	7.30
Max.input current		A	31.7
Compressor	Model		MVB40FKMMC
	Type		ROTARY
	Brand		Mitsubishi Electric
	Capacity	kW	13.68
	Input	kW	4.34
	Rated load current	A	14.60
	Locked rotor Amp	A	37.8
	Thermal protector		Inner
	Refrigerant oil type,charge		FW68S,1250
Outdoor fan motor	Model		SIC-88FWJ-F1180-1
	Type		DC Motor
	Brand		NIDEC SHIBAURA
	Input	kW	180
	Speed	r/min	160-780
Outdoor coil	Number of rows		2
	Tube pitch(a)× row pitch(b)	mm	21*18.186
	Fin spacing	mm	1.4
	Fin type		Hydrophilic aluminum foil
	Tube outside dia. and type	mm	φ7
	Coil length ×height	mm	1005*1302
	Number of circuits		10

Model			AU162FYCRA(HW)
Water pump	Type		UPMXL GEO 25-125 130 PWM-Grundfos
	Input (H/M/L)	W	180/130/90
	Pumping head	m	12.5
Outdoor air flow		m ³ /h	7200
Throttle			EXV
Outdoor noise level (sound power)*(3)		dB(A)	68
Flow rate of water		m ³ /h	2.75
The water pressure drop of heat-exchanger		kPa	40
The Max. and Min. water inlet pressure		kPa	500/150
Outdoor unit	Net dimension (W×H×D)	mm	1500×950×370
	Packing dimension(W×H×D)	mm	1638×1010×480
	Net/ Gross weight	kg	145/157
Refrigerant	Type		R32
	Charged volume	kg	2.60
Connection wiring	Power wire	mm ²	3×10.0
Pipe diameter	Water inlet/outlet	inch	Rc1
Controller (optional)			Wired controller
Ambient temperature range			Cooling: 10~46°C Heating: -20~35°C(Antifreeze must be added below 5)
Leaving water temperature range			Cooling: 5~20°C Heating: 25~55°C
Accessory	Wired Controller		YR-E27
	Domestic hot water PCB		ATW-A01
<p>Note: Specifications are based on the following conditions:</p> <ol style="list-style-type: none"> Cooling: (*1) Entering/leaving water temperature: 12/7°C, outdoor ambient temperature 35°C DB. (*2) Entering/leaving water temperature: 23/18°C, outdoor ambient temperature 35°C DB. Heating: (*3) Entering/leaving water temperature: 40/45°C, outdoor ambient temperature 7°C DB/6°C WB . (*4) Entering/leaving water temperature: 30/35°C, outdoor ambient temperature 7°C DB/6°C WB . It is tested in a semi-anechoic room (sound power). The above data may be changed without notice for future improvement on quality and performance. 			

6. Dimensions

AU052FYCRA(HW) (Unit: mm)

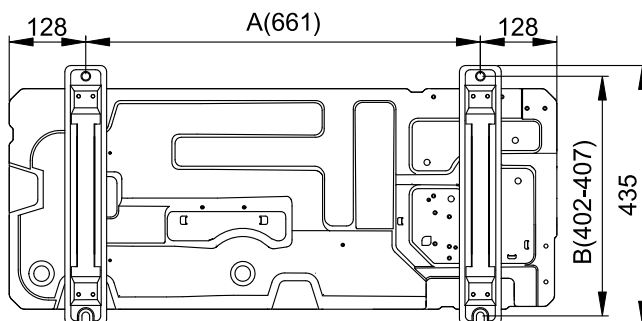
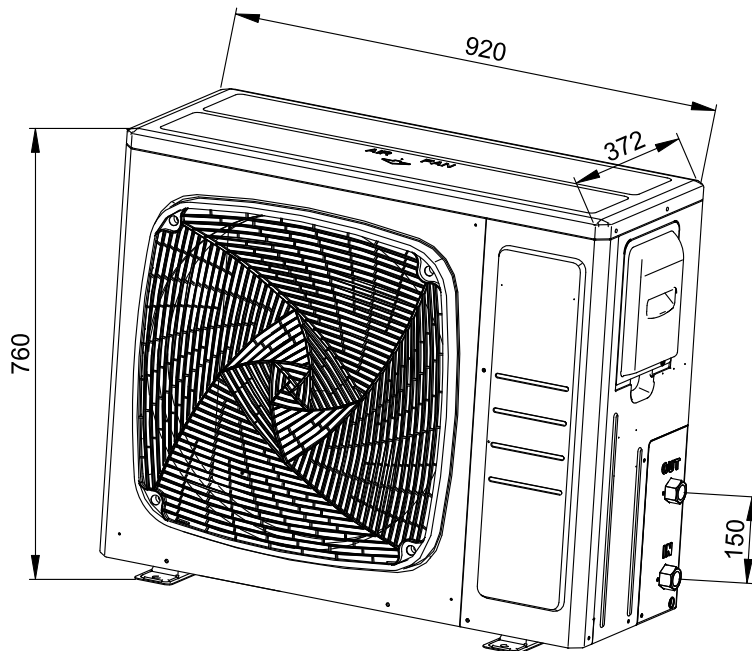

AU082FYCRA(HW) (Unit: mm)

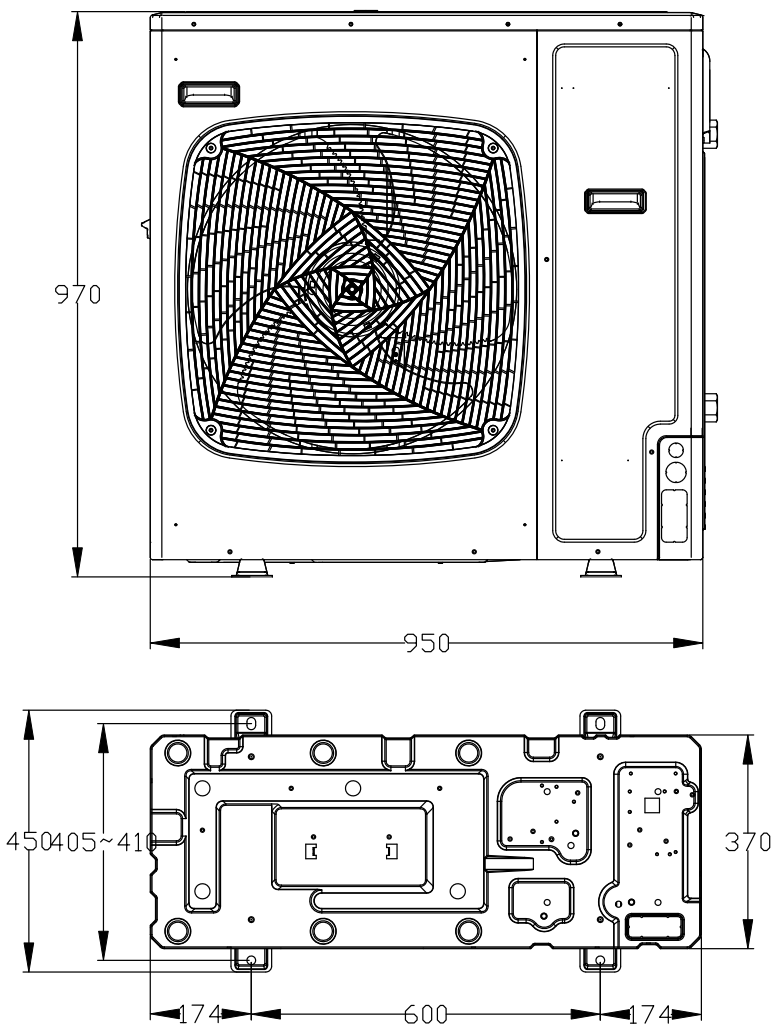

AU112/162FYCRA(HW) (Unit: mm)

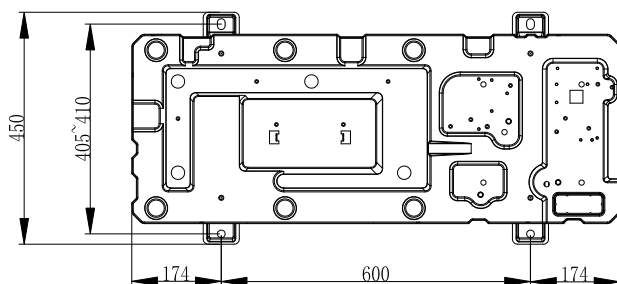
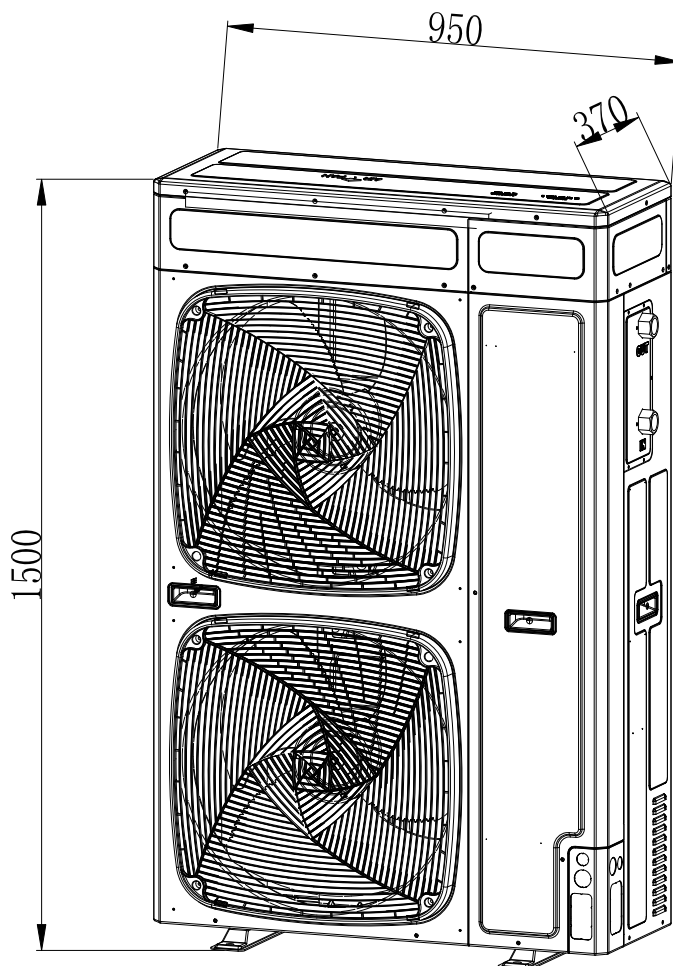

7. Piping Diagram

AU052FYCRA(HW)

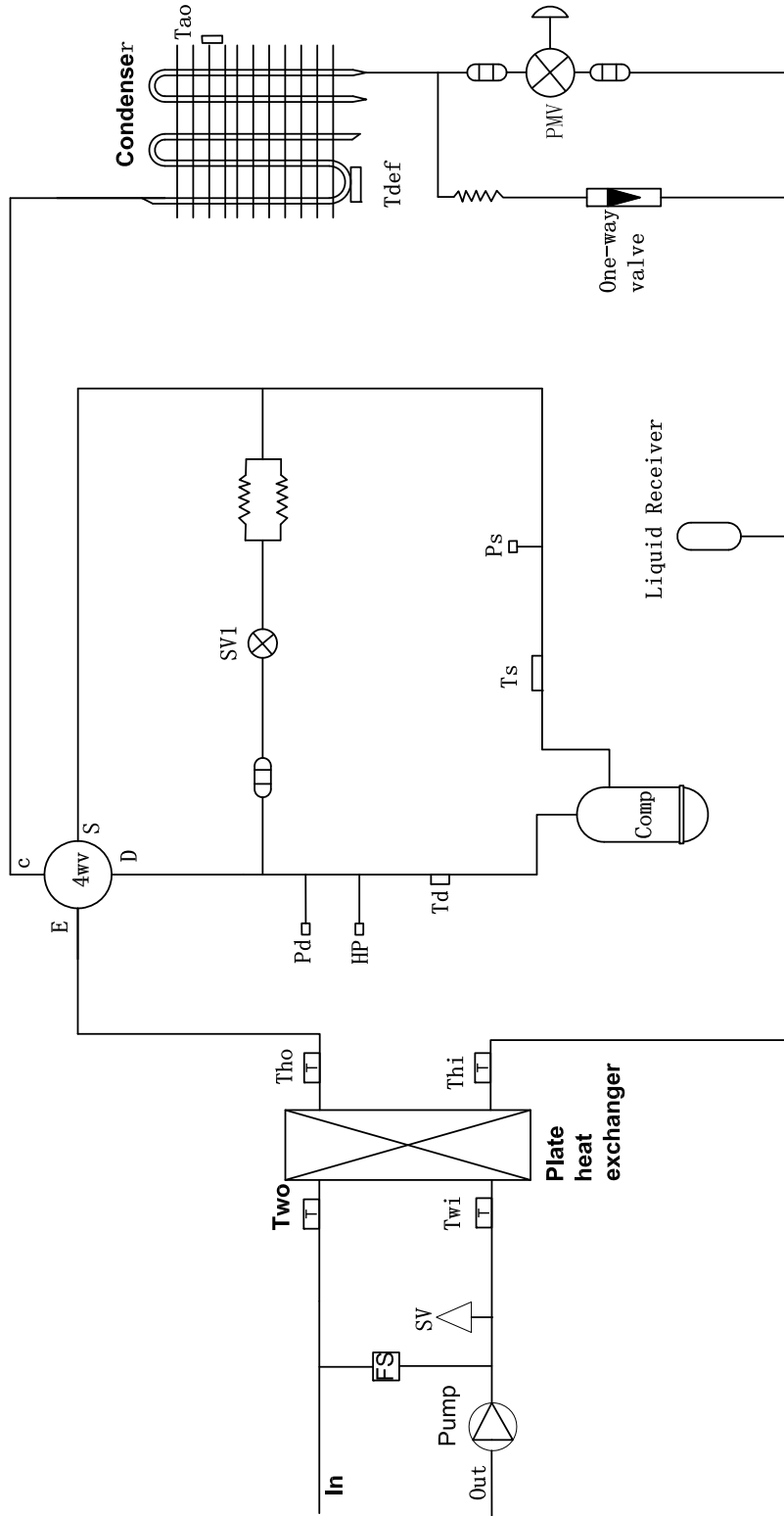

AU082FYCRA(HW)

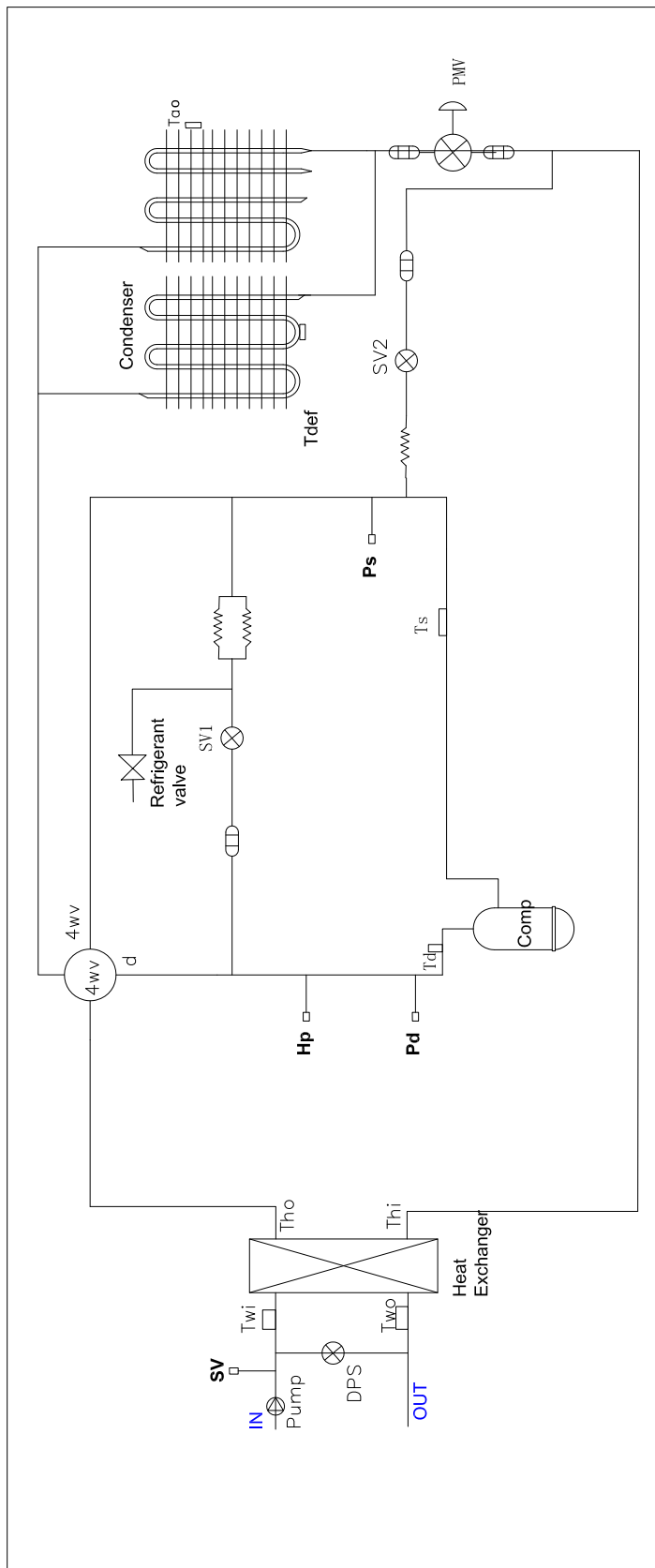

AU112/162FYCRA(HW)

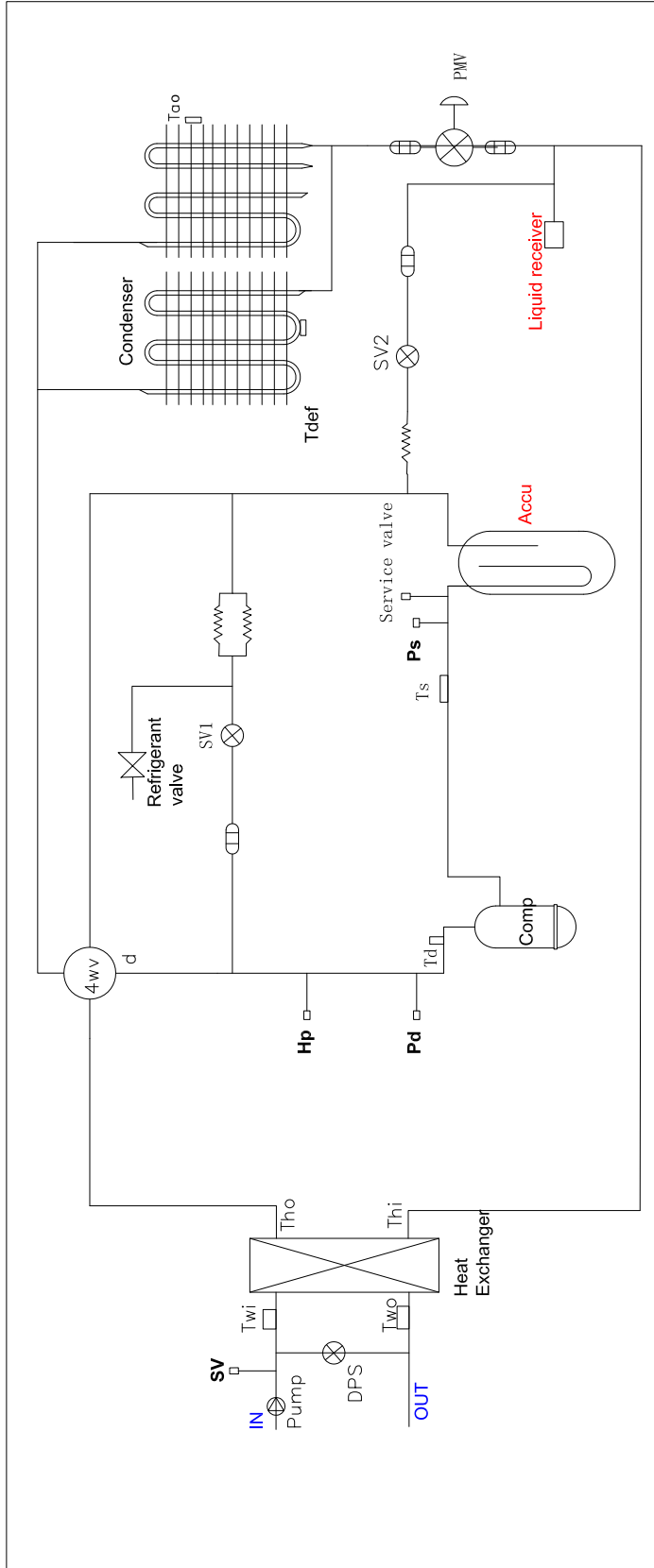

Part name	Model	Sign	Function	Date
Compressor	SVB172FNQMC-L2 AU052FYCRA(HW)	Comp.	Capacity control, meet indoor load request by adjusting the frequency	Motor resistance (at 20°C): 1.96Ω
	SVB200FKMMC AU082FYCRA(HW)			Motor resistance (at 20°C): 1.94Ω
	TVB306FKMMC AU112FYCRA(HW)			Motor resistance (at 20°C): 1.53Ω
	MVB40FKMMC AU162FYCRA(HW)			Motor resistance (at 20°C): 0.72Ω
Pressure sensor	ALL	Pd	High pressure detection	Pressure range:0 to 4.15MPa
		Ps	Low pressure detection	Pressure range:0 to 1.7MPa
Pressure switch	ALL	Hp	High pressure protection	4.15MPa, OFF
Electronic expansion valve	AU052FYCRA(HW)	PMV	In heating, refrigerant flow control	Φ1.5
	AU082FYCRA(HW)			Φ1.8
	AU112/162FYCRA(HW)			Φ2.5
4-way valve	ALL	4WV	Change over between cooling and heating	AC220V, electrified in heat; not electrified in cooling or defrosting
Solenoid valve	ALL	SV1	Keep balance of high/low pressure when compressor starts up or stops	AC220V
	AU082/112/162 FYCRA(HW)	SV2	Refrigerant jet protection when discharging temp. is too high	
Liquid receiver	AU052FYCRA(HW)	/	Used to storage the refrigerant	Volume:0.3L
	AU112/162FYCRA(HW)	/		Volume:1.1L
Gas-liquid separator	AU112/162FYCRA(HW)	ACCU	Used to separate the gas and liquid	Φ90*350
Refrigerant valve	ALL	/	Used to charge the refrigerant to unit	Φ7
Service valve	AU112/162FYCRA(HW)	/	Used to detect the pressure	HPb59-1 S12.5
Flow switch	AU052FYCRA(HW)	DPS	Detect Flow rate	0.003MPa OFF 0.0045MPa ON
	AU082FYCRA(HW)			0.012MPa OFF 0.009MPa ON
	AU112/162FYCRA(HW)			0.008MPa, OFF 0.0055MPa ON
Pump	AU052/082FYCRA(HW)	Pump	Transport liquid	Pumping head:8m
	AU112/162FYCRA(HW)			Pumping head:12.5m
Heat exchanger	AU052FYCRA(HW)	/	Used to exchange the heat from refrigerant to water	Design pressure: water side:1.5MPa; Refrigerant side:4.2MPa
	AU082FYCRA(HW)			Design pressure: water side:1.5MPa; Refrigerant side:4.2MPa
	AU112/162FYCRA(HW)			Design pressure: shell side:1.0MPa; Tube pass:4.2MPa
Safety valve	ALL	SV	Reduce system pressure	Operation pressure:0.55MPa

Part name	Model	Sign	Function	Date
Temp. sensor	ALL	Tdef	Check frost condition of outdoor heat exchanger	R(25°C)=10KB (25/50°C)=3700K
		Ts	suction temp. of compressor	
		Tao	Detect ambient temp. set primary setting for fan speed target pressure and PMV open angl	
		Thi	Detect the in refrigerant temp. of heat exchanger	
		Tho	Detect the out refrigerant temp. of heat exchanger	
		Twi	Detect the inlet water temp. of heat exchanger	
		Two	Detect the outlet water temp. of heat exchanger	
		Td	Detect the discharging temp. of compressor	R (80°C)=50KB (25/80°C)=4450K

8. Wiring Diagram

AU052FYCRA(HW)

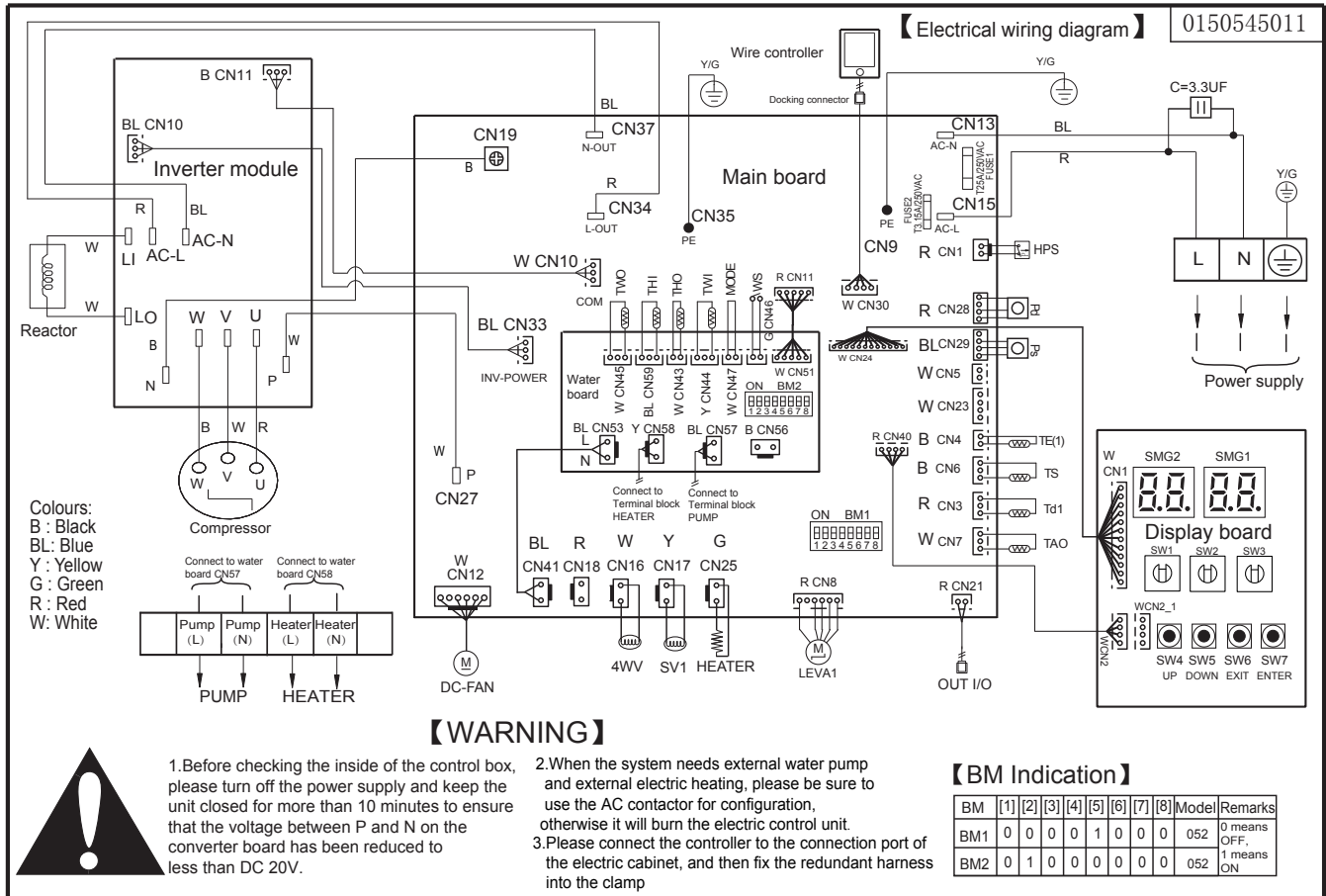

Note: CN47 doesn't work if ATW-A01 box is used/connected

AU082FYCRA(HW)

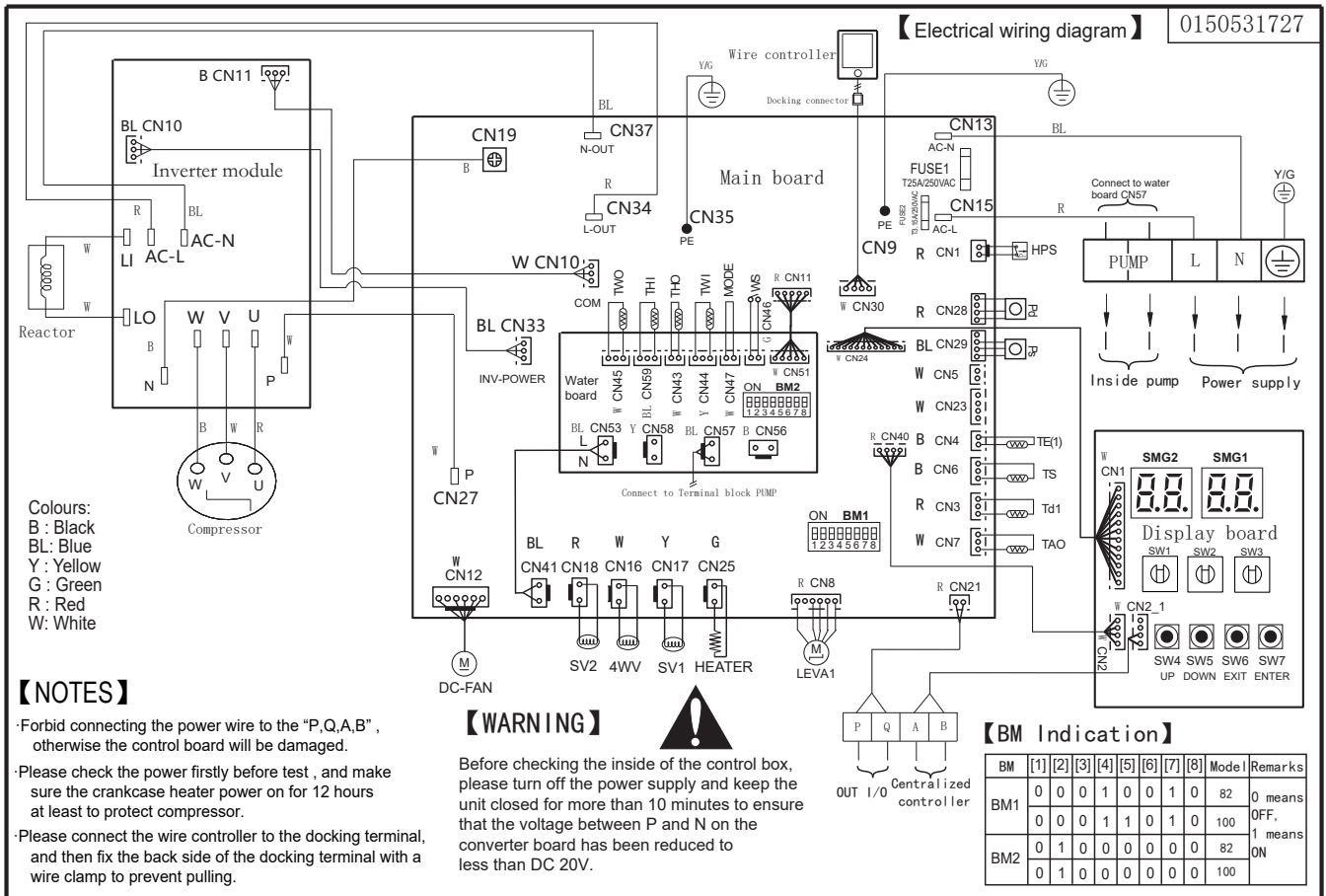

Note: CN47 doesn't work if ATW-A01 box is used/connected

AU112/162FYCRA(HW)

【Electrical wiring diagram】

0150531728

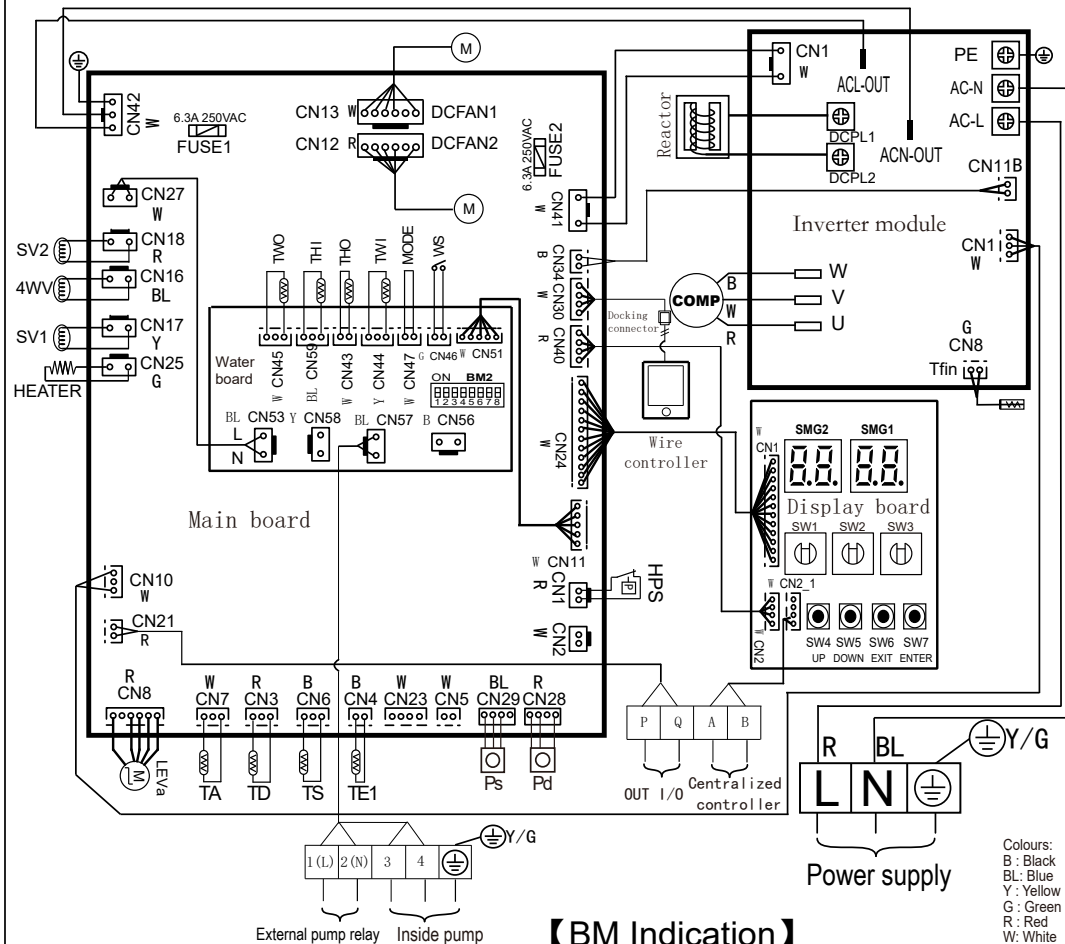

【WARNING】



Before checking the inside of the control box, please turn off the power supply and keep the unit closed for more than 10 minutes to ensure that the voltage between P and N on the converter board has been reduced to less than DC 20V.

【NOTES】

- Forbid connecting the power wire to the "P,Q,A,B", otherwise the control board will be damaged.
- Please check the power firstly before test, and make sure the crankcase heater power on for 12 hours at least to protect compressor.
- Please connect the wire controller to the docking terminal, and then fix the back side of the docking terminal with a wire clamp to prevent pulling.

【BM Indication】

BM	[1]	[2]	[3]	[4]	[5]	[6]	[7]	[8]	Mode I	Remarks
BM1	0	0	1	0	0	0	1	0	112	0 means OFF, 1 means ON
	0	0	1	0	1	0	1	0	162	
BM2	0	1	0	0	0	0	0	0	112	0 means OFF, 1 means ON
	0	1	0	0	0	0	0	0	162	

Symbol	Signification	Symbol	Signification
ACL	Live Wire	HPS	high pressure switch
ACN	Neutral Wire	LPS	low pressure switch
HEATER	Heater	TD	compressor discharge sensor
SV1	unloading valve	TE(1)	defrost temp sensor
SV2	spray valve	Tfin	IPM temperature sensor
4WV	4 way valve	TS	compressor suction sensor
AB	Monitor	TA	ambient temp sensor
DCFAN1	up fan	EEV	electronic expansion valve
DCFAN2	down fan	LD1-3	digital display tubes
LED1-4	lights	SW01,02	thumbwheels

Note: CN47 doesn't work if ATW-A01 box is used/connected

9. Electric Characteristics

Model	Outdoor Unit					Power Supply		Compressor	OFM	
	Hz	Voltage	Phase	Min.	Max.	MCA	MFA	MSC	kW	FLA
AU052FYCRA(HW)	50Hz	220~240V	1Ph	198V	264V	21.3	32	4.2	0.18	0.8
AU082FYCRA(HW)	50Hz	220~240V	1Ph	198V	264V	21.3	32	4.2	0.18	0.8
AU112FYCRA(HW)	50Hz	220~240V	1Ph	198V	264V	24.3	32	8.5	0.18+0.18	0.8+0.8
AU162FYCRA(HW)	50Hz	220~240V	1Ph	198V	264V	31.7	40	14	0.18+0.18	0.8+0.8

Remark:

MCA: Min. Current Amps. (A)

MFA: Max. Fuse Amps. (A)

MSC: Max. Starting Amps. (A)

OFM: Outdoor Fan Motor

FLA: Full Load Amps. (A)

kW: Rated Motor Output (kW)

10. Capacity Tables

10.1 Cooling capacity

AU052FYCRA(HW)						
Air temp.	Capacity(kW) Nom.	Capacity(kW) Min.	Capacity(kW) Max.	EER(EN14511) Nom.	EER Min.	EER Max.
DB	Water flow temperature 20 °C					
45	5.00	1.50	4.55	3.60	2.05	4.05
35	6.00	1.80	6.60	5.04	3.72	5.70
25	7.50	2.25	8.25	7.50	5.21	8.24
15	7.90	2.37	8.69	8.60	6.49	9.80
10	8.22	2.47	9.04	9.92	7.54	10.90
DB	Water flow temperature 18 °C					
45	4.80	1.34	5.28	3.50	1.88	3.52
35	5.00	1.61	5.50	5.00	3.41	4.96
25	5.95	2.01	6.55	5.85	4.78	7.17
15	6.83	2.12	7.51	6.90	5.95	8.52
10	7.20	2.20	7.92	7.85	6.92	9.48
DB	Water flow temperature 10 °C					
45	4.08	1.14	4.49	2.50	1.42	2.91
35	4.80	1.34	5.28	3.57	2.59	4.10
25	5.28	1.48	5.81	4.18	3.62	5.92
15	5.81	1.63	6.39	4.93	4.51	7.04
10	6.10	1.71	6.71	5.61	5.24	7.83
DB	Water flow temperature 7 °C					
45	3.74	1.12	4.12	2.03	1.14	2.41
35	5.00	1.50	5.50	3.20	2.07	3.39
25	4.76	1.43	5.24	3.40	2.90	4.89
15	5.35	1.61	5.89	4.01	3.61	5.82
10	5.76	1.73	6.33	4.56	4.19	6.47

AU082FYCRA(HW)						
Air temp.	Capacity(kW) Nom.	Capacity(kW) Min.	Capacity(kW) Max.	EER(EN14511) Nom.	EER Min.	EER Max.
DB	Water flow temperature 20 °C					
45	6.75	2.03	7.43	3.95	3.81	4.05
35	7.86	2.36	8.65	3.42	3.47	5.70
25	8.69	2.61	9.56	5.13	4.90	8.24
15	9.60	2.88	10.56	7.53	7.19	10.75
10	10.17	3.05	11.19	9.36	9.47	11.45
DB	Water flow temperature 18 °C					
45	5.95	1.79	6.55	3.93	3.79	4.02
35	7.00	2.10	7.70	3.40	3.45	5.66
25	8.24	2.47	9.06	5.10	4.87	8.18
15	9.11	2.73	10.03	7.47	7.14	10.68
10	9.33	2.80	10.27	9.85	9.41	10.98
DB	Water flow temperature 15 °C					
45	5.92	1.66	6.46	2.21	2.15	3.09
35	6.73	1.89	7.34	2.95	2.92	4.19
25	7.66	2.15	8.35	4.30	4.12	6.03
15	8.48	2.37	9.24	6.28	6.01	8.39
10	8.71	2.44	9.50	8.49	8.08	10.20
DB	Water flow temperature 10 °C					
45	5.16	1.44	5.67	1.97	1.91	2.69
35	6.06	1.70	6.67	2.63	2.60	3.64
25	6.67	1.87	7.34	3.82	3.66	5.25
15	7.34	2.05	8.07	5.59	5.35	7.30
10	7.71	2.16	8.48	7.55	7.19	8.88
DB	Water flow temperature 7 °C					
45	4.24	1.27	4.66	1.95	1.78	2.49
35	5.50	1.65	6.05	2.35	2.47	3.47
25	5.39	1.62	5.93	3.81	3.47	4.86
15	6.06	1.82	6.67	5.49	5.01	7.02
10	6.52	1.96	7.17	7.21	6.35	8.41
DB	Water flow temperature 5 °C					
45	4.14	1.24	4.97	1.75	1.58	2.10
35	4.79	1.44	5.75	2.15	2.20	2.93
25	5.35	1.61	6.42	3.41	3.09	4.09
15	5.94	1.78	7.12	4.91	4.46	5.98
10	6.28	1.88	7.54	6.94	5.65	7.74

AU112FYCRA(HW)						
Air temp.	Capacity(kW) Nom.	Capacity(kW) Min.	Capacity(kW) Max.	EER(EN14511) Nom.	EER Min.	EER Max.
DB	Water flow temperature 20 °C					
45	12.78	3.83	13.42	3.66	3.25	4.51
35	13.91	4.17	14.60	4.87	4.25	6.56
25	15.64	4.69	16.42	6.55	5.78	9.84
15	17.19	5.16	18.05	9.13	7.33	10.71
10	17.70	5.31	18.59	11.41	11.38	11.75
DB	Water flow temperature 18 °C					
45	12.41	3.72	13.03	3.45	3.06	4.25
35	13.50	4.05	14.18	4.60	4.01	6.19
25	15.18	4.55	15.94	6.18	5.45	9.29
15	16.69	5.01	17.52	8.61	6.91	10.40
10	16.75	5.03	17.59	11.08	10.74	11.93
DB	Water flow temperature 15 °C					
45	11.87	3.56	13.05	2.83	2.51	3.49
35	13.22	4.63	14.54	3.81	3.29	5.07
25	14.43	5.05	15.88	5.06	4.47	7.62
15	15.21	5.32	16.73	7.06	5.67	8.52
10	15.97	5.59	17.57	9.08	8.80	9.78
DB	Water flow temperature 10 °C					
45	10.24	3.17	11.77	2.49	2.21	3.07
35	12.91	4.00	14.85	3.35	2.90	4.46
25	13.96	4.33	16.05	4.46	3.94	6.70
15	15.31	4.75	17.61	6.21	4.99	7.50
10	15.91	4.93	18.29	7.99	7.75	8.61
DB	Water flow temperature 7 °C					
45	9.77	2.93	10.74	2.14	1.96	2.46
35	11.50	3.45	11.60	3.00	3.03	3.40
25	12.90	3.87	14.19	3.88	3.47	4.69
15	14.14	4.24	15.56	5.24	4.54	6.74
10	15.25	4.58	16.78	7.64	6.62	8.45
DB	Water flow temperature 5 °C					
45	9.39	2.82	10.32	2.07	1.88	2.26
35	10.76	3.23	11.83	2.84	2.91	3.12
25	12.11	3.63	13.32	3.77	3.34	4.32
15	13.25	3.97	14.57	5.05	4.36	6.20
10	14.03	4.21	15.43	6.08	6.36	7.77

AU162FYCRA(HW)						
Air temp.	Capacity(kW) Nom.	Capacity(kW) Min.	Capacity(kW) Max.	EER(EN14511) Nom.	EER Min.	EER Max.
DB	Water flow temperature 20 °C					
45	15.05	4.64	15.80	3.15	3.15	4.34
35	16.80	5.18	17.64	4.62	3.97	6.34
25	19.05	5.88	20.00	5.88	5.09	9.56
15	20.95	6.46	21.99	8.29	6.46	11.35
10	21.13	6.52	23.25	11.37	10.53	12.01
DB	Water flow temperature 18 °C					
45	14.33	4.30	15.05	3.00	3.00	4.14
35	16.00	4.80	16.80	4.40	3.78	6.04
25	18.14	5.44	19.05	5.60	4.85	9.10
15	19.95	5.98	20.95	7.89	6.15	10.81
10	20.13	6.04	22.14	10.83	10.03	11.43
DB	Water flow temperature 15 °C					
45	12.05	3.61	13.25	2.74	2.74	3.65
35	15.30	4.59	16.06	3.62	3.44	5.26
25	15.53	4.66	18.63	5.01	4.45	7.81
15	17.05	5.12	20.46	6.81	5.68	11.47
10	17.53	5.26	21.03	10.50	9.63	11.20
DB	Water flow temperature 10 °C					
45	11.44	3.43	12.59	2.33	2.31	2.85
35	14.84	4.45	16.32	3.00	2.89	4.02
25	14.13	4.24	15.54	4.04	3.77	5.75
15	15.52	4.66	17.07	5.41	4.88	8.78
10	15.95	4.79	17.55	9.78	9.47	10.58
DB	Water flow temperature 7 °C					
45	11.18	3.36	12.30	2.35	2.32	2.69
35	14.50	4.35	16.53	2.95	2.89	3.74
25	13.71	4.11	15.08	3.93	3.79	5.17
15	15.05	4.52	16.56	5.19	4.97	7.45
10	15.47	4.64	17.02	7.58	7.24	9.59
DB	Water flow temperature 5 °C					
45	10.16	3.05	11.18	2.24	2.20	2.46
35	13.24	3.97	14.56	2.80	2.73	3.36
25	13.43	4.03	14.77	3.65	3.63	4.51
15	14.75	4.43	16.23	4.78	4.78	6.13
10	15.16	4.55	16.68	5.23	4.85	8.05

10.2 Heating capacity

AU052FYCRA(HW)							
Air temp.		Capacity(kW) Nom.	Capacity(kW) Min.	Capacity(kW) Max.	COP(EN14511) Nom.	COP Min.	COP Max.
DB	WB	Water flow temperature 25 °C					
35	24	8.94	3.51	13.10	7.26	5.45	9.30
27	19	7.99	2.93	12.36	6.92	5.19	8.78
20	19	7.19	2.34	11.62	6.40	4.80	8.14
10	9	6.00	1.95	9.32	5.62	4.21	6.44
7	6	5.50	1.82	8.60	5.25	3.94	5.92
2	1	5.23	1.43	6.35	4.57	3.43	4.72
0	-1	5.17	1.35	5.82	4.20	3.15	4.64
-3	-4	5.08	1.28	5.44	4.05	2.90	4.42
-7	-8	4.84	1.19	4.77	3.75	2.52	4.11
-15	-16	3.48	1.08	4.14	2.63	1.77	3.88
-20	-21	2.44	0.79	2.53	1.71	1.15	3.70
DB	WB	Water flow temperature 35 °C					
35	24	8.13	2.77	9.35	6.99	5.24	7.42
27	19	7.26	2.07	8.35	6.65	4.99	6.97
20	19	6.54	1.57	7.52	6.16	4.62	6.42
10	9	5.45	1.31	6.27	5.40	4.05	5.68
7	6	5.00	1.20	5.75	5.05	3.79	5.41
2	1	4.75	1.14	5.46	4.39	3.30	5.18
0	-1	4.70	1.13	5.41	4.04	3.03	5.09
-3	-4	4.43	1.06	5.10	3.45	2.79	4.87
-7	-8	4.22	1.06	4.85	3.19	2.57	4.55
-15	-16	3.04	0.76	3.49	2.23	1.80	4.28
-20	-21	2.13	0.53	2.45	1.45	1.17	4.26
DB	WB	Water flow temperature 45 °C					
35	24	6.73	2.49	7.74	5.33	4.26	6.58
27	19	6.29	1.86	7.24	5.07	4.06	5.78
20	19	5.94	1.41	6.83	4.70	3.76	5.13
10	9	5.30	1.18	6.10	4.12	3.30	4.54
7	6	5.00	1.08	5.75	3.85	3.08	4.33
2	1	4.80	1.03	5.52	3.35	2.68	4.14
0	-1	4.70	1.02	5.41	3.08	2.47	4.07
-3	-4	4.37	0.96	5.02	2.95	2.27	3.89
-7	-8	4.20	0.95	4.83	2.73	2.09	3.64
-15	-16	2.86	0.68	3.28	1.91	1.46	3.21
-20	-21	1.86	0.48	2.13	1.24	0.95	3.19
DB	WB	Water flow temperature 55 °C					
35	24	6.02	2.06	6.62	4.08	2.65	5.60
27	19	5.78	1.66	6.36	3.89	2.53	4.75
20	19	5.62	1.26	6.18	3.60	2.34	3.85
10	9	5.20	1.05	5.72	3.16	2.05	3.41
7	6	5.00	0.96	5.50	2.95	1.92	3.25
2	1	4.85	0.91	5.34	2.57	1.67	3.11
0	-1	4.70	0.90	5.17	2.36	1.53	3.05
-3	-4	4.39	0.85	4.83	2.32	1.41	2.92
-7	-8	4.18	0.85	4.60	2.15	1.30	2.73
-15	-16	2.72	0.61	2.99	1.51	1.16	2.41
-20	-21	1.63	0.43	1.79	1.01	0.81	2.40

AU082FYCRA(HW)							
Air temp.		Capacity(kW) Nom.	Capacity(kW) Min.	Capacity(kW) Max.	COP(EN14511) Nom.	COP Min.	COP Max.
DB	WB	Water flow temperature 25 °C					
35	24	13.06	4.81	14.14	7.05	6.75	7.61
27	19	12.26	4.01	13.34	6.61	6.03	7.19
20	19	11.46	3.21	12.54	6.20	5.35	6.67
10	9	9.20	2.66	10.06	4.90	4.25	5.27
7	6	8.47	2.49	9.29	4.73	4.04	4.85
2	1	6.23	1.95	6.85	3.53	3.07	3.86
0	-1	5.81	1.85	6.28	3.48	2.97	3.80
-3	-4	5.40	1.75	5.88	3.33	2.80	3.61
-7	-8	4.74	1.63	5.15	3.14	2.51	3.36
-15	-16	4.12	1.48	4.47	2.97	2.40	3.18
-20	-21	2.54	1.08	2.73	2.96	2.27	3.03
DB	WB	Water flow temperature 35 °C					
35	24	12.46	4.21	13.54	6.75	6.45	7.31
27	19	11.66	3.41	12.74	6.31	5.73	6.89
20	19	10.86	2.61	11.94	5.90	5.05	6.37
10	9	8.60	2.06	9.46	4.60	3.95	4.97
7	6	7.80	1.87	8.69	4.40	3.74	4.55
2	1	5.63	1.35	6.25	3.23	2.77	3.56
0	-1	5.21	1.25	5.68	3.18	2.67	3.50
-3	-4	4.80	1.15	5.28	3.03	2.50	3.31
-7	-8	4.14	1.03	4.55	2.84	2.21	3.06
-15	-16	3.52	0.88	3.87	2.67	2.10	2.88
-20	-21	1.94	0.48	2.13	2.66	1.97	2.73
DB	WB	Water flow temperature 45 °C					
35	24	11.53	3.58	12.87	5.98	5.86	6.58
27	19	10.98	2.74	12.14	5.31	5.03	5.78
20	19	10.61	2.50	11.46	4.73	4.35	5.09
10	9	8.35	1.98	9.02	3.75	3.45	3.98
7	6	7.50	1.80	8.65	3.20	3.18	3.64
2	1	5.36	1.30	5.89	2.78	2.36	2.85
0	-1	5.00	1.20	5.50	2.64	2.25	2.80
-3	-4	4.63	1.10	5.09	2.55	2.07	2.65
-7	-8	4.00	0.99	4.40	2.43	1.90	2.45
-15	-16	3.48	0.84	3.83	2.30	1.85	2.16
-20	-21	1.32	0.46	1.45	2.18	1.80	2.04
DB	WB	Water flow temperature 55 °C					
35	24	10.89	3.10	11.97	5.19	4.65	5.12
27	19	10.05	2.54	11.24	4.56	3.97	4.53
20	19	9.47	2.30	10.41	3.54	3.26	3.82
10	9	7.58	1.82	8.34	4.07	2.58	2.98
7	6	7.01	1.65	7.71	2.54	2.38	2.73
2	1	5.08	1.19	5.59	2.21	1.77	2.14
0	-1	4.71	1.11	5.18	2.04	1.69	2.10
-3	-4	4.42	1.02	4.87	1.94	1.55	1.99
-7	-8	3.77	0.91	4.14	1.82	1.43	1.84
-15	-16	0.87	0.78	0.95	2.08	1.38	1.62
-20	-21	0.51	0.43	0.56	1.83	1.35	1.53

AU112FYCRA(HW)							
Air temp.		Capacity(kW) Nom.	Capacity(kW) Min.	Capacity(kW) Max.	COP(EN14511) Nom.	COP Min.	COP Max.
DB	WB	Water flow temperature 25 C					
35	24	18.30	5.49	19.58	8.09	7.28	8.22
27	19	17.50	5.25	18.73	7.36	6.62	7.47
20	19	16.30	4.89	17.44	6.69	6.02	6.80
10	9	13.90	4.17	14.88	5.11	4.59	5.19
7	6	12.00	3.60	12.84	4.62	4.17	4.70
2	1	9.74	2.92	10.42	3.69	3.32	3.75
0	-1	9.49	2.85	10.15	3.56	3.20	3.62
-3	-4	8.82	2.65	9.44	3.39	3.05	3.45
-7	-8	7.93	2.38	8.49	2.99	2.70	3.04
-15	-16	7.43	2.23	7.95	2.71	2.44	2.74
-20	-21	4.22	1.26	4.51	2.47	2.24	2.49
DB	WB	Water flow temperature 35 C					
35	24	17.4	5.23	18.30	7.36	7.14	7.56
27	19	16.3	4.89	17.12	6.69	6.49	6.98
20	19	15.30	4.59	16.07	6.08	5.47	6.18
10	9	12.90	3.87	14.55	4.64	4.17	4.72
7	6	11.00	3.30	14.06	4.20	3.79	4.28
2	1	8.74	2.62	9.18	3.36	3.02	3.41
0	-1	8.49	2.55	8.91	3.24	2.91	3.29
-3	-4	7.82	2.35	8.21	3.08	2.77	3.13
-7	-8	6.93	2.08	7.28	2.72	2.45	2.76
-15	-16	6.43	1.93	6.75	2.46	2.21	2.49
-20	-21	3.22	0.96	3.38	2.25	2.04	2.27
DB	WB	Water flow temperature 45 C					
35	24	16.8	5.04	18.48	5.39	4.55	5.42
27	19	15.68	4.70	17.25	4.56	3.87	4.83
20	19	14.42	4.33	15.86	4.37	2.78	4.44
10	9	12.19	3.66	14.62	3.69	3.20	3.75
7	6	10.50	3.15	13.65	3.20	3.06	3.54
2	1	7.21	2.16	7.93	3.00	2.58	3.07
0	-1	6.85	2.06	7.54	2.78	2.41	2.83
-3	-4	6.32	1.89	6.95	2.66	2.30	2.69
-7	-8	5.64	1.69	6.20	2.41	2.18	2.56
-15	-16	5.13	1.54	5.65	2.31	2.09	2.46
-20	-21	2.57	0.77	2.82	2.16	1.97	2.30
DB	WB	Water flow temperature 55 C					
35	24	15.45	4.64	17.00	4.17	3.89	4.51
27	19	14.56	4.37	16.02	3.43	3.31	3.46
20	19	13.42	4.03	14.76	2.80	2.77	2.87
10	9	11.12	3.33	12.23	2.39	2.37	2.44
7	6	9.99	3.00	10.99	2.27	2.26	2.31
2	1	8.40	2.52	9.24	2.00	1.98	2.03
0	-1	7.98	2.39	8.78	1.89	1.87	1.92
-3	-4	7.22	2.17	7.94	1.80	1.78	1.83
-7	-8	6.18	1.85	6.80	1.64	1.62	1.67
-15	-16	2.78	0.84	3.06	1.57	1.52	1.54
-20	-21	1.10	0.44	1.21	1.38	1.36	1.41

AU162FYCRA(HW)							
Air temp.		Capacity(kW) Nom.	Capacity(kW) Min.	Capacity(kW) Max.	COP(EN14511) Nom.	COP Min.	COP Max.
DB	WB	Water flow temperature 25 C					
35	24	26.30	6.31	28.93	7.32	6.74	7.84
27	19	24.90	5.97	27.39	6.90	6.35	7.40
20	19	23.61	5.67	25.97	6.51	5.99	6.98
10	9	18.84	4.52	20.72	5.05	4.65	5.33
7	6	17.44	4.19	19.18	4.57	4.27	4.83
2	1	11.08	2.66	12.19	3.43	3.14	3.68
0	-1	10.14	2.43	11.15	3.06	2.76	3.50
-3	-4	9.90	2.38	10.89	3.04	2.75	3.34
-7	-8	9.33	2.24	10.26	2.87	2.46	2.98
-15	-16	8.65	2.08	9.52	2.71	2.51	2.81
-20	-21	5.19	1.25	5.71	1.97	1.82	2.14
DB	WB	Water flow temperature 35 C					
35	24	24.13	5.55	26.30	6.65	6.12	7.13
27	19	22.84	5.25	24.90	6.27	5.78	6.72
20	19	21.66	4.98	23.61	5.92	5.45	6.34
10	9	17.28	3.97	18.84	4.59	4.23	4.84
7	6	16.00	3.68	17.01	4.15	3.89	4.39
2	1	10.17	2.34	11.08	3.12	2.86	3.35
0	-1	9.30	2.14	10.14	2.78	2.51	3.18
-3	-4	9.08	2.09	9.90	2.76	2.50	3.04
-7	-8	8.56	1.97	9.33	2.61	2.23	2.71
-15	-16	7.94	1.98	8.65	2.46	2.28	2.55
-20	-21	4.76	1.19	5.19	1.79	1.66	1.94
DB	WB	Water flow temperature 45 C					
35	24	21.83	5.02	23.79	4.58	4.93	5.63
27	19	20.94	4.82	22.82	4.32	4.65	5.31
20	19	19.87	4.37	21.85	4.08	4.39	5.01
10	9	16.70	3.67	18.36	3.44	3.41	3.83
7	6	15.00	3.30	16.46	3.25	3.13	3.47
2	1	9.77	2.15	10.74	2.68	2.30	2.64
0	-1	9.04	1.99	9.94	2.52	2.02	2.51
-3	-4	8.82	1.94	9.70	2.42	2.01	2.40
-7	-8	8.40	1.85	9.24	2.29	1.80	2.14
-15	-16	7.40	1.63	8.14	1.82	1.83	2.02
-20	-21	3.15	0.91	3.47	1.72	1.33	1.53
DB	WB	Water flow temperature 55 C					
35	24	20.43	4.70	22.27	3.54	3.70	4.22
27	19	19.14	4.40	20.86	3.34	3.49	3.98
20	19	18.31	4.03	20.15	3.15	3.29	3.76
10	9	17.60	3.87	19.36	2.66	2.55	2.87
7	6	14.01	3.08	15.41	2.49	2.35	2.60
2	1	9.30	2.05	10.23	1.97	1.72	1.98
0	-1	8.83	1.94	9.71	1.86	1.52	1.89
-3	-4	8.06	1.77	8.87	1.77	1.51	1.80
-7	-8	7.58	1.67	8.34	1.65	1.35	1.60
-15	-16	3.50	1.47	3.85	1.57	1.38	1.51
-20	-21	1.48	0.67	1.63	1.49	1.00	1.15

11. Operation Limits Delivery-Leaving

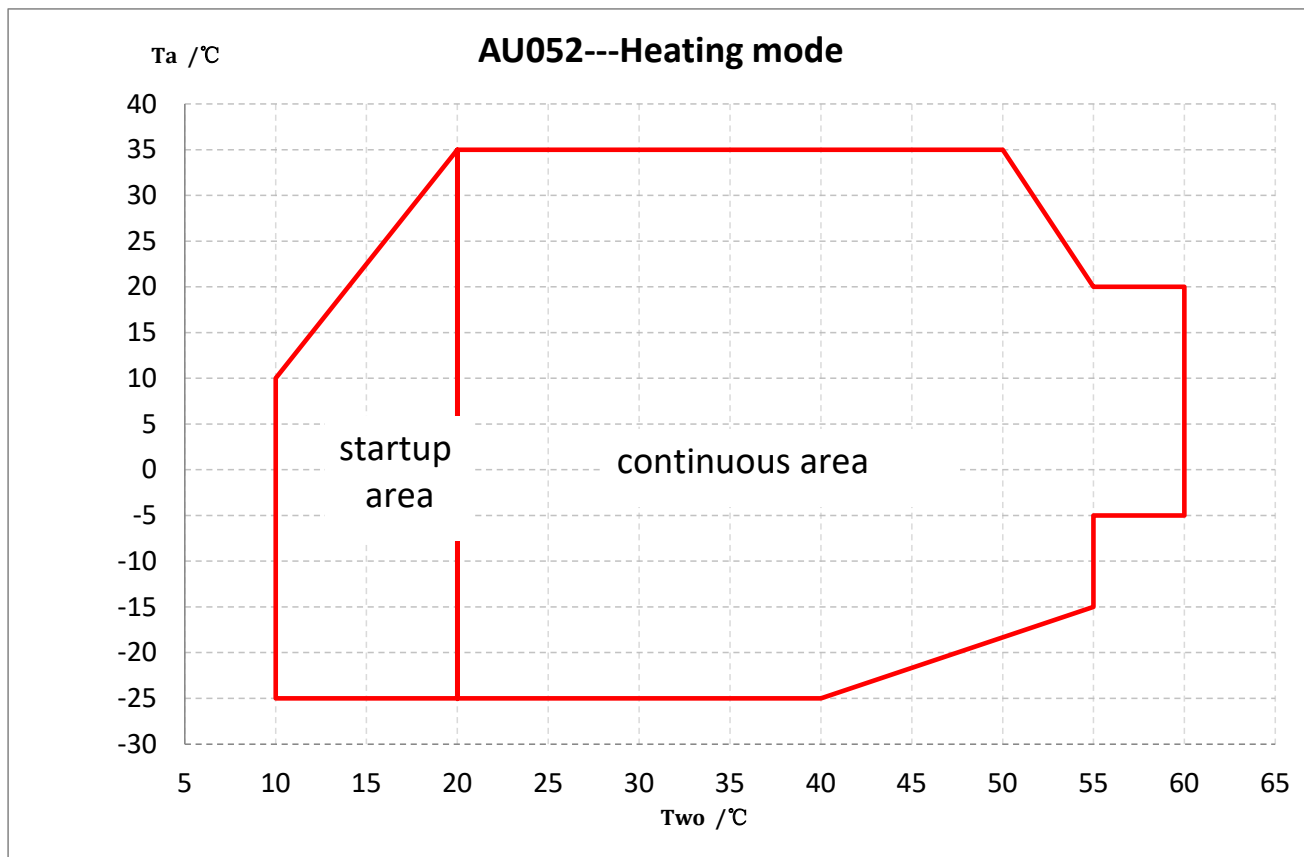

Ta: Ambient temperature

Two: Outlet water temperature

AU052---heating														
Water temperature	20	10	10	20	20	40	55	55	60	60	55	50	20	20
Ambient temperature	-25	-25	10	35	-25	-25	-15	-5	-5	20	20	35	35	-25

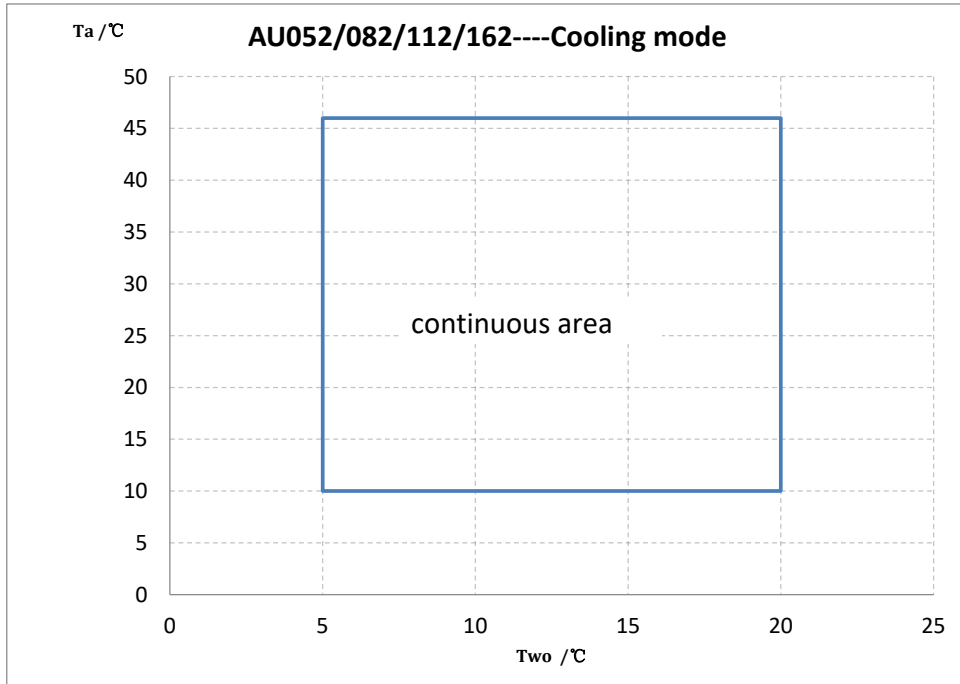

Ta: Ambient temperature

Two: Outlet water temperature

AU052/082/112/162---cooling					
Water temperature	5	20	20	5	5
Ambient temperature	10	10	46	46	10

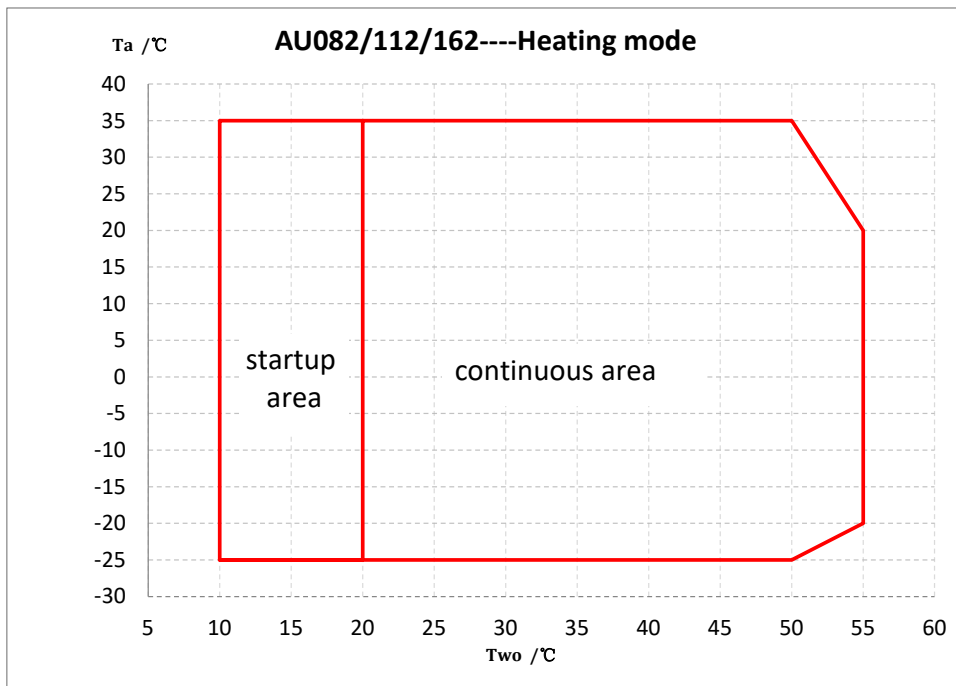

AU052---heating									
Water temperature	10	50	55	55	50	10	10	20	20
Ambient temperature	-25	-25	-20	20	35	35	-25	-25	35

a) Ethylene Glycol Solutions

Water and ethylene glycol solutions used as a thermal vector in the place of water reduce the performance of the unit. Multiply the performance figures by the values given in the following table.

Freezing point (C)						
	0	-5	-10	-15	-20	-25
Percentage of ethylene glycol in weight						
	0	12%	20%	28%	35%	40%
cPf	1	0.98	0.97	0.965	0.96	0.955
cQ	1	1.02	1.04	1.075	1.11	1.14
cdp	1	1.07	1.11	1.18	1.22	1.24

cPf: correction factor of heating/cooling capacity

cQ: correction factor of flow rate

cdp: correction factor of pressure drop

Note:

1. During winter leaving the unit unused, please drain water out completely from unit if no anti-freeze were charged into pipeline, or keep power on (at standby or off status) and ensure that water is contained inside of unit.
2. When ambient temperature lower 5, running cooling mode must be charged antifreeze. Refers to upper parameters for the charged volume.

b) Fouling Factors

The performance data given refer to conditions with clean evaporator plates (fouling factor=1). For different fouling factors, multiply the figures in the performance tables by the coefficient given in the following table.

Fouling factors	Evaporator		
(m ² °C/W)	f1	fk1	fx1
4.4×10 ⁻⁵	-	-	-
0.86×10 ⁻⁴	0.96	0.99	0.99
1.72×10 ⁻⁴	0.93	0.98	0.98

f1: correction factor of capacity

fk1: power input correction factor of compressor

fx1: correction factor of total power input

12. Water Pressure Drop

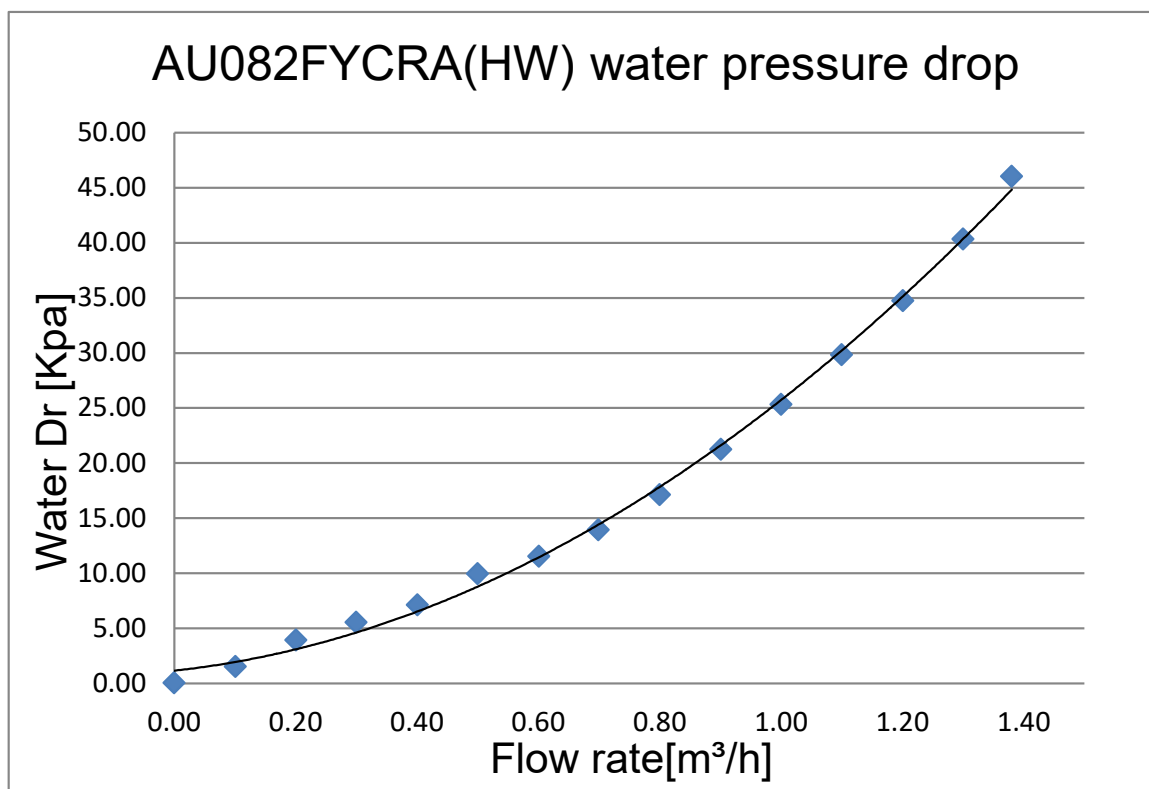
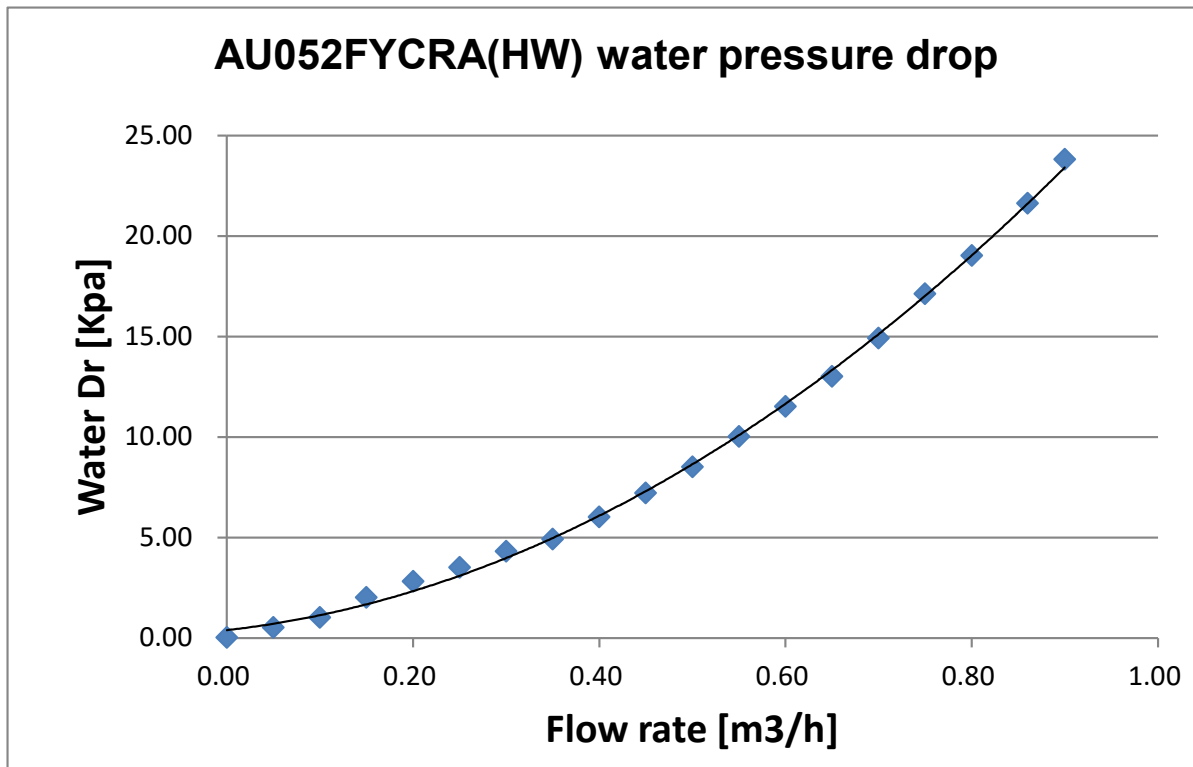

AU112FYCRA(HW) water pressure drop

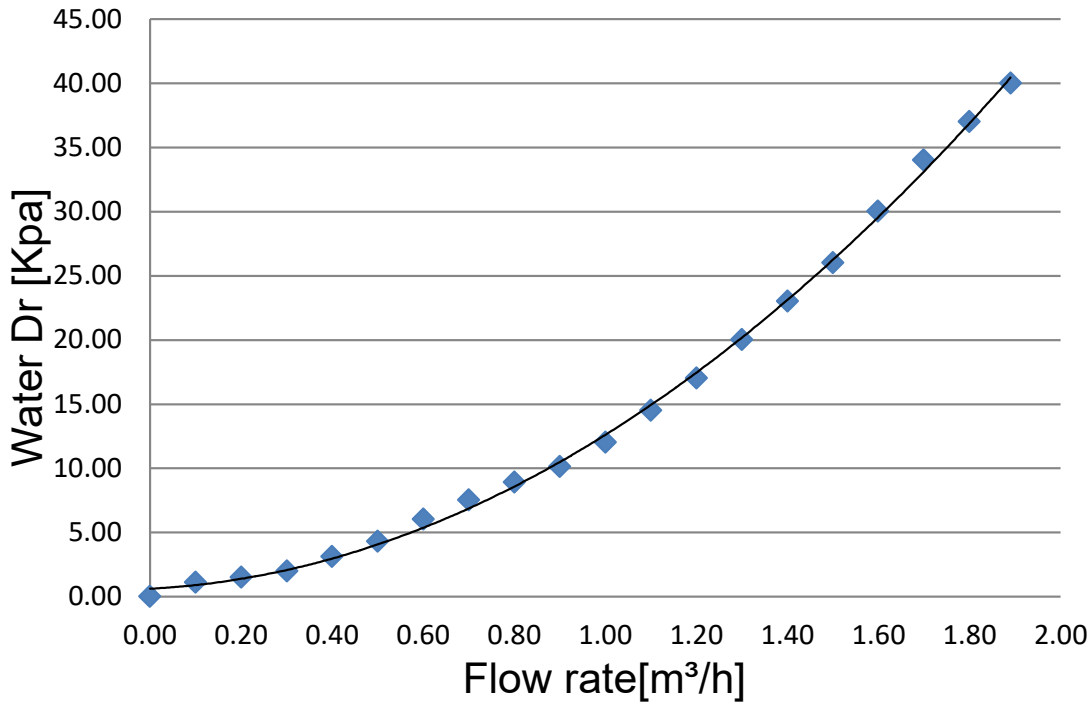

AU162FYCRA(HW) water pressure drop

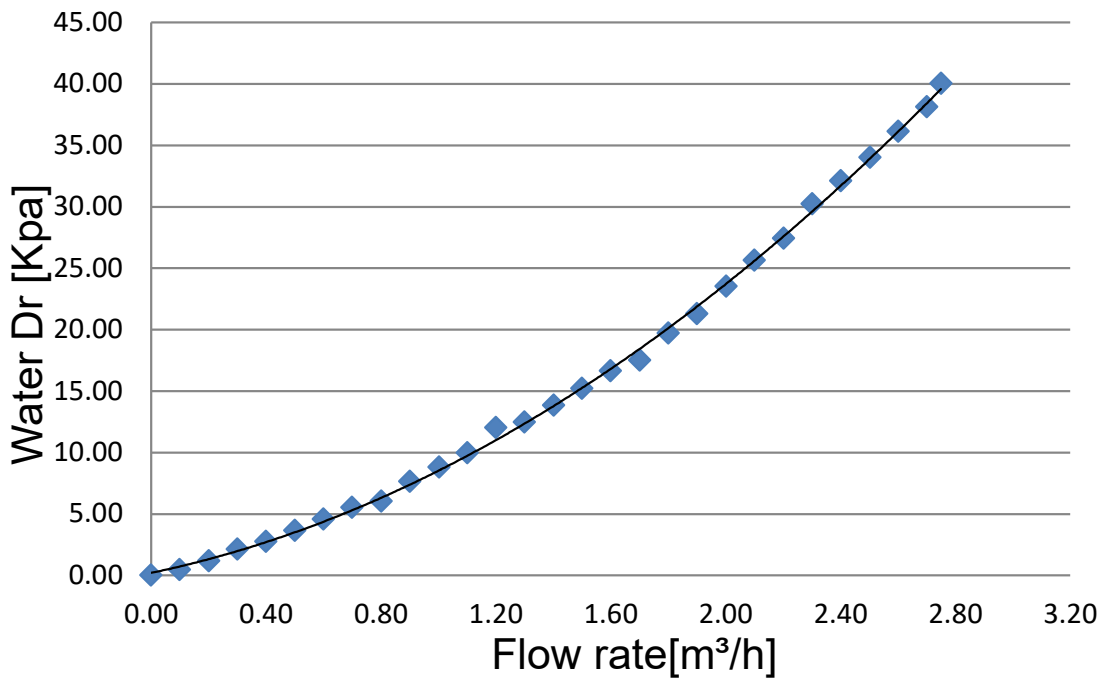

13. Sound Level

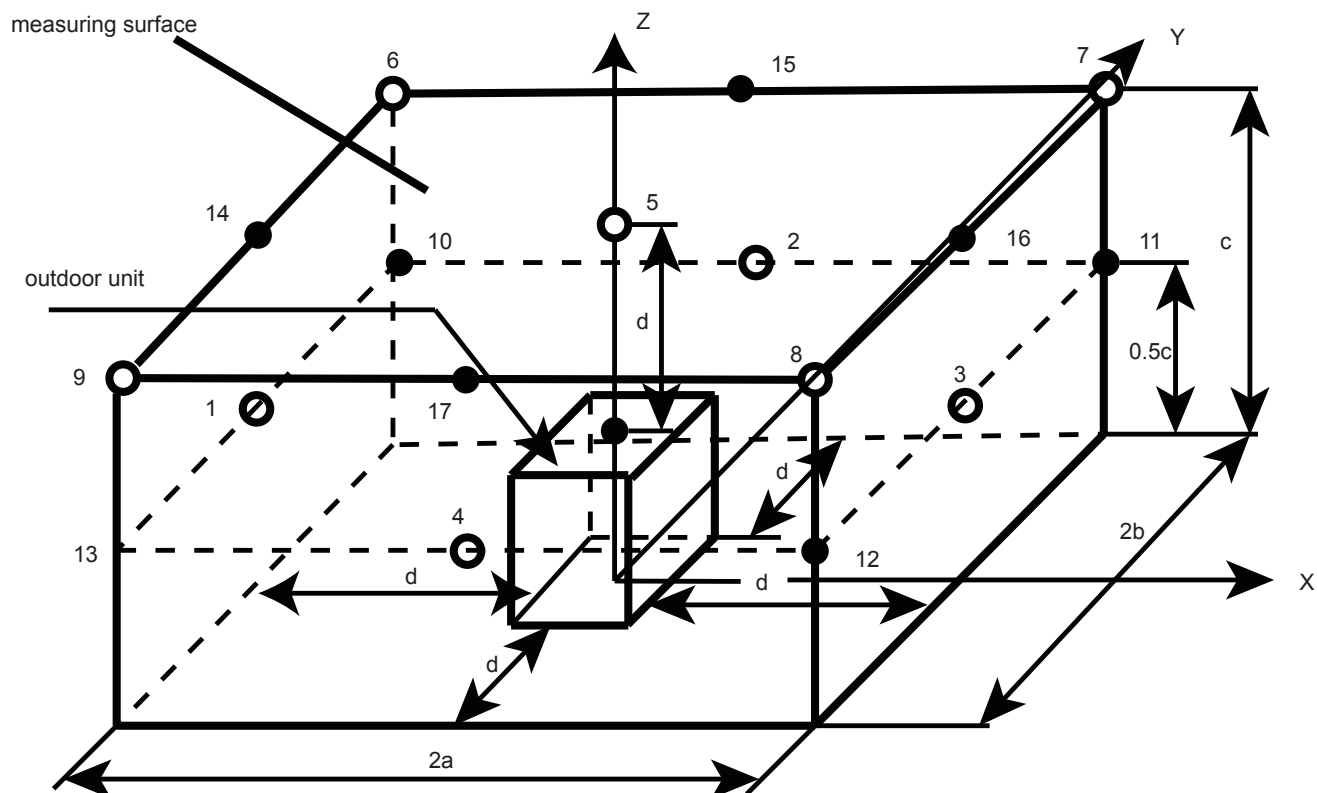

Model	Noise level (dB)
AU052FCYRA(HW)	61
AU082FCYRA(HW)	61
AU112FCYRA(HW)	63
AU162FCYRA(HW)	68

Note:

It is tested 1 meter(d) away from the machine in a semi-anechoic room (sound power).

14. Installation

EUROPEAN REGULATIONS CONFORMITY FOR THE MODELS

CE

All the products are in conformity with the following European provision:
 -Low voltage Directive
 -Electromagnetic Compatibility

ROHS

The products are fulfilled with the requirements in the directive 2011/65/EU of the European parliament and of council on the Restriction of the use of Certain Hazardous Substances in Electrical and Electronic Equipment(EU RoHS Directive)

WEEE

In accordance with the directive 2012/19/EU of the European parliament, herewith we inform the consumer about the dis-posal requirements of the electrical and electronic products.

DISPOSAL REQUIREMENTS:



Your air conditioning product is marked with this symbol. This means that electrical and electronic products shall not be mixed with unsorted household waste. Do not try to dismantle the system yourself: the dismantling of the air conditioning system, treatment of the refrigerant, of oil and of other part must be done by a qualified installer in accordance with relevant local and national legislation. Air conditioners must be treated at a specialized treatment facility for reuse, recycling and recovery. By ensuring this product is disposed of correctly, you will help to prevent potential negative consequences for the environment and human health. Please contact the installer or local authority for more information.

Battery must be removed from the remote controller and dis-posed of separately in accordance with relevant local and national legislation.

⚠ Warning

- If the supply cord is damaged, it must be replaced by the manufacturer, its service agent or similarly qualified persons in order to avoid a hazard.
- This appliance is not intended for use by persons (including children) with reduced physical, sensory or mental capabilities, or lack of experience and knowledge, unless they have been given supervision or instruction concerning use of the appliance by a person responsible for their safety.
- Children should be supervised to ensure that they do not play with the appliance.
- This appliance can be used by children aged from 8 years and above and persons with reduced physical, sensory or mental capabilities or lack of experience and knowledge if they have been given supervision or instruction concerning use of the appliance in a safe way and understand the hazards involved. Children shall not play with the appliance. Cleaning and user maintenance shall not be made by children without supervision.
- The appliances are not intended to be operated by means of an external timer or separate remote-control system.
- Keep the appliance and its cord out of reach of children less than 8 years.
- Disconnect the appliance from its power source during maintenance service and when replacing parts.
- Air conditioner working temperature: cooling -10~46 degree, heating -15~24 degree.

IMPORTANT INFORMATION REGARDING THE REFRIGERANT USED

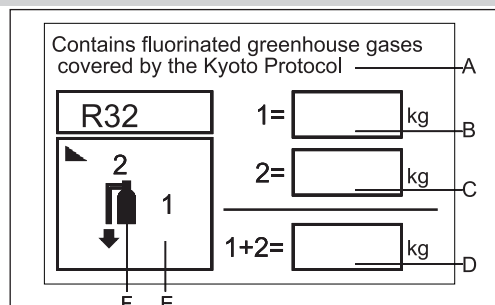

This product contains fluorinated greenhouse gases covered by the Kyoto Protocol. Do not vent into the atmosphere.

Refrigerant type: R32

GWP* value: 675

GWP = global warming potential

Please fill in with indelible ink,

1 the factory refrigerant charge of the product
 2 the additional refrigerant amount charged in the field and 1+2 the total refrigerant charge on the refrigerant charge label supplied with the product. The filled out label must be adhered in the proximity of the product charging port (e.g. onto the inside of the stop value cover).

A contains fluorinated greenhouse gases covered by the Kyoto Protocol

B factory refrigerant charge of the product: see unit name plate





C additional refrigerant amount charged in the field

D total refrigerant charge

E outdoor unit

F refrigerant cylinder and manifold for charging

14.1 Safety

	Read the precautions in this manual carefully before operating the unit.		This appliance is filled with R32.
	Read the operator's manual .		Service indicator, read technical manual.

After reading this handbook, hand it over to those who will be using the unit.

The user of the unit should keep this manual at hand and make it available to those who will be performing repairs or relocating the unit. Also, make it available to the new user when the user changes hands.

⚠WARNING

- Ask your dealer or qualified personnel to carry out installation work. Do not attempt to install the air conditioner yourself. Improper Installation may result in water leakage, electric shocks, fire or explosion.
- All the cables shall have got the European authentication certificate. During installation, when the connecting cables break off, it must be assured that the grounding wire is the last one to be broken off.
- If refrigerant gas leaks during installation, ventilate the area immediately. Toxic gas may be produced if the refrigerant comes into contact with fire, and explosion may happen.
- Make sure ground connection is correct and reliable. Do not earth the unit to a utility pipe, lightning conductor or telephone earth lead. Imperfect earthing may result in electric shocks.
- The breaker of the air conditioner should be all-pole switch and explosion-proof. The distance between its two contacts should not be no less than 3mm. Such means for disconnection must be incorporated in the wiring.
- The electrical sockets should be placed 1m above from the air conditioner, nor under the air conditioner. Be sure not to use open flame, high static electrical or high temperature equipments etc. nearby the air conditioner.
- Do not use means to accelerate the defrosting process or to clean, other than those recommended by the manufacturer.
- The appliance must be stored in a room without continuously operating ignition sources, the radius of the storage area should be no less than 2.5 m (for example: open flames, an operating gas appliance or an operating electric heater).
- Do not pierce or burn.
- Be aware that refrigerants may not contain an odour.
- The appliance must be installed, operated and stored in a room with a floor area larger than the Minimum Room Area specified in the table on the following pages, The room should be well ventilated.
- Comply with national gas regulations.
- This appliance can be used by children aged 8 years and above and persons with reduced physical, sensory or mental capabilities or lack of experience and knowledge if they have been given supervision or instruction concerning use of the appliance in a safe way and understand the hazards involved. Children shall not play with the appliance. Cleaning and user maintenance shall not be made by children without supervision.
- The air conditioner can not be discarded or scrapped Randomly If you need please contact customer service personnel of Haier to scrap in order to obtain the correct disposal methods.
- Reusable mechanical connectors and flared joints are not allowed indoor.

⚠CAUTION

- Do not install the air conditioner at any place where there is danger of flammable gas leakage. In the event of a gas leakage, build-up of gas near the air conditioner may cause a fire to break out.
- Take adequate steps to prevent the outdoor unit being used as a shelter by small animals. Small animals making contact with electrical parts can cause malfunctions, smoke or fire.
- Please instruct the customer to keep the area around the unit clean
- The temperature of refrigerant circuit will be high, please keep the inter-unit wire away from copper pipes that not thermally insulated.
- Only qualified personnel can handle, fill, purge and dispose of the refrigerant.

⚠WARNING

The installation, maintenance, service and repair operations of this product shall be carried out by professional personnel, who have been trained and certified by national training organizations that are accredited to teach the relevant national competency standards that may be set in legislation.
Improper installation may cause water leakage, electrical shock, fire, or explosion.

Install the air conditioner according to the instructions given in this manual.
Incomplete installation may cause water leakage, electrical shock, fire, or explosion.

Be sure to use the supplied or specified installation parts.
Use of other parts may cause the unit to come to lose, water leakage, electrical shock, fire, or explosion.

Install the air conditioner on a solid base that can support the unit's weight.
An inadequate base or incomplete installation may cause injury in the event the unit falls off the base.

Electrical work should be carried out in accordance with the installation manual and the national electrical wiring rules or code of practice.
Insufficient capacity or incomplete electrical work may cause electrical shock, fire, or explosion.

Be sure to use a dedicated power circuit. Never use a power supply shared by another appliance.

For wiring, use a cable long enough to cover the entire distance with no connection.
Do not use an extension cord. Do not put other loads on the power supply, use a dedicated power circuit.
(Failure to do so may cause abnormal heat, electrical shock, fire, or explosion.)

After connecting interconnecting and supply wiring be sure to shape the cables so that they do not put undue force on the electrical covers or panels.
Install covers over the wires. Incomplete cover installation may cause terminal overheating, electrical shock, fire, or explosion.

If any refrigerant has leaked out during the installation work, ventilate the room.
(The refrigerant produces a toxic gas if exposed to flames, may cause explosion.)

After all installation is complete, check to make sure that no refrigerant is leaking out.
(The refrigerant produces a toxic gas if exposed to flames, may cause explosion.)

When installing or relocating the system, be sure to keep the refrigerant circuit free from substances other than the specified refrigerant(R32), such as air.
(Any presence of air or other foreign substance in the refrigerant circuit causes an abnormal pressure rise or rupture, resulting in injury.)

During pump-down, stop the compressor before removing the refrigerant piping.
If the compressor is still running and the stop valve is open during pump-down, air will be sucked in when the compressor is run, causing abnormal pressure in the freezer cycle which will lead to breakage and even injury.

Be sure to establish an earth. Do not earth the unit to a utility pipe, arrester, or telephone earth.
Incomplete earth may cause electrical shock, fire, or explosion. A high surge current from lightning or other sources may cause damage to the air conditioner.
The installation of pipe-work shall be kept to a minimum.
Pipe-work shall be protected from physical damage and shall not be installed in an unventilated space, if that space is smaller than the Minimum Room Area specified in the table on the following pages.
Mechanical connections shall be accessible for maintenance purposes.
Information for handling, installation, cleaning, servicing and disposal of refrigerant.
Warning: Keep any required ventilation openings clear of obstruction.
Notice: Servicing shall be performed only as recommended by this manual instruction.

Be sure to install an earth leakage breaker.
Failure to install an earth leakage breaker may result in electric shocks, fire, or explosion.

Loading and Unloading/Transporting Management/Storage Requirements

Loading and Unloading Requirements

- 1) The products shall be carefully handled during loading and unloading.
- 2) Rude and barbarous handling such as kicking, throwing, dropping, bumping, pulling and rolling is not allowed.
- 3) The workers engaged in loading and unloading must be subject to necessary trainings on the potential hazards caused by barbarous handling.
- 4) Dry powder extinguishers or other suitable fire extinguishing apparatus within the period of validity shall be equipped at the loading and unloading site.
- 5) The untrained personnel cannot be engaged in loading and unloading of flammable refrigerants air conditioner.
- 6) Before loading and unloading, anti-static measures shall be taken, and phones cannot be answered during loading and unloading.
- 7) Smoking and open fire are not allowed around the air conditioner.

Transporting Management Requirements

- 1) The maximum transporting volume of finished products shall be determined as per local regulations.
- 2) The vehicles used for transporting shall be operated as per local laws and regulations.
- 3) Dedicated after-sales vehicles shall be used for maintenance, and exposed transporting of refrigerant cylinders and the products to be maintained is not allowed.
- 4) The rain cover or similar shielding material of transporting vehicles shall be provided with certain flame retardancy.
- 5) Leakage warning device of flammable refrigerant shall be installed inside the closed-type compartment.
- 6) Anti-static device shall be equipped inside the compartment of transporting vehicles.
- 7) Dry powder extinguishers or other suitable fire extinguishing apparatus within the period of validity shall be equipped inside the driver's cab.
- 8) Orange-white or red-white reflective stripes shall be pasted on the sides and tail of the transporting vehicles, to remind the vehicles behind of keeping distance.
- 9) The transporting vehicles shall run at a constant speed, and heavy acceleration/deceleration shall be avoided.
- 10) Combustibles or the static articles cannot be transported simultaneously.
- 11) High-temperature area shall be avoided during transporting, and necessary radiating measures shall be taken in case the temperature inside the compartment is too high.

Storage Requirements

- 1) The storage package of equipment used shall be such that no leakage of refrigerant will be caused due to mechanical damage of the equipment inside.
- 2) The appliance must be stored in a room without continuously operating ignition sources, the radius of the storage area should be no less than 2.5 m (for example: open flames, an operating gas appliance or an operating electric heater).
- 3) Do not pierce or burn.
- 4) The maximum quantity of the equipment allowed to be stored together shall be determined as per local regulations.

Type	LFL kg/m ³	hv m	Minimum Room Area						
			Total Mass Charged/kg Minimum Room Area/m						
R32	0.306		1.224	1.836	2.448	3.672	4.896	6.12	7.956
		0.6		29	51	116	206	321	543
		1.0		10	19	42	74	116	196
		1.8		3	6	13	23	36	60
		2.2		2	4	9	15	24	40

Safety Awareness

1. Procedures: operation shall be made as per controlled procedures to minimize the probability of risks.
2. Area: area shall be divided and isolated appropriately, and operation in an enclosed space shall be avoided. Before the refrigeration system is started or before working, ventilation or opening of the area shall be guaranteed.
3. Site inspection: the refrigerant shall be checked.
4. Fire control: the fire extinguisher shall be placed nearby, and fire source or high temperature is not allowed; the sign of "No smoking" shall be arranged.

Unpacking Inspection

1. Indoor unit: nitrogen is sealed during the delivery of indoor units (inside the evaporator), and the red sign at the top of the green plastic seal cap on the evaporator air pipes of the indoor unit shall be checked first after unpacking. In case the sign is raised, the nitrogen sealed still exists. Afterwards, the black plastic seal cap at the joint of evaporator liquid pipes of the indoor unit shall be pressed, to check whether nitrogen still exists. In case no nitrogen is sprayed out, the indoor unit is subject to leakage, and installation is not allowed.
2. Outdoor unit: the leak detection equipment shall be extended into the packing box of the outdoor unit, to check whether the refrigerant is leaking. If the refrigerant leakage is identified, installation is not allowed, and the outdoor unit shall be delivered to the maintenance department.

Inspection on Installation Environment

1. Inspection on the surrounding environment of place of installation: the outdoor unit of flammable refrigerants air conditioner cannot be installed inside an enclosed room reserved.
2. Power supply, switches or other high-temperature articles such as the fire source and oil heater shall be avoided below the indoor unit.
3. The power supply shall be provided with earthing wire and be reliably earthed.
4. While punching the wall with an electric drill, whether embedded water/electricity/gas pipelines are designed at the hole preset by the user shall be verified in advance. It is recommended that the through-wall holes reserved shall be used as much as possible

Safety Principles of Installation

1. Favorable ventilation shall be maintained at the place of installation (doors and windows are opened).
2. Open fire or high-temperature heat source (including welding, smoking and oven) higher than 548 is not allowed within the scope of flammable refrigerant.
3. Anti-static measures shall be taken, such as the wearing of cotton clothes and cotton gloves.
4. The place of installation shall be convenient for installation or maintenance. Barriers shall be avoided around the air inlet/outlet of the indoor/outdoor unit, and the electrical appliance, power switches, sockets, valuables and high-temperature products within the scope of both sidelines of the indoor unit shall be avoided, and cannot be adjacent to heat source and flammable and combustible environment.
5. In case the product is damaged, it must be delivered to the maintenance point. Welding of refrigerant pipelines at the user's site is not allowed.



Caution, risk of fire



No Smoking



Cotton clothes



Anti-static gloves



BEWARE
ELECTROSTATICS



Goggles

Electrical Safety Requirements

1. The surrounding conditions (ambient temperature, direct sunlight and rainwater) shall be noticed during electrical wiring, with effective protective measures being taken.
2. Copper wire cable in line with local standards shall be used as the power line and connector wire.
3. Outdoor unit shall be reliably earthed.
4. The dedicated branch circuit must be used, and leakage protector with sufficient capacity must be installed.

Qualification Requirements of Installer

Relevant qualification certificate must be obtained as per national laws and regulations.

Outdoor Unit Installation

Fixing and connection

Note:

- a) Fire source shall be avoided within 3m around the place of installation.
- b) The leak detection equipment of refrigerant shall be placed at a low position in the outdoor, and shall be opened.



Fixing

The support of the outdoor unit shall be fixed onto the wall surface, and then the outdoor unit shall be fixed onto the support horizontally. In case the outdoor unit is wall-mounted or roof-mounted, the support shall be firmly fixed, to avoid the damage of strong wind.

Post-installation Inspection Items and Test Run

Post-installation Inspection Items

Items to Be Checked	Consequence of Improper Installation
Whether the installation is firm or not	The unit may fall, vibrate or make a noise
Whether the inspection on air leakage is completed	The refrigerating capacity (heating capacity) may be insufficient
Whether the unit is fully insulated	Condensation or drip may occur
Whether the drainage is smooth or not	Condensation or drip may occur
Whether the power voltage is identical to that marked on the nameplate	Failure may occur or the parts may be burned
Whether the circuit and pipeline are installed correctly	Failure may occur or the parts may be burned
Whether the unit is safely earthed	Electric leakage may occur
Whether the type of wire is in line with relevant regulations	Failure may occur or the parts may be burned
Whether barriers are identified at the air inlet/outlet of the outdoor unit	The refrigerating capacity (heating capacity) may be insufficient

Maintenance Instructions

Maintenance Precautions

Precautions

- For all the faults requiring welding the refrigeration pipelines or components inside the refrigeration system of R32 refrigerant air conditioners, maintenance at the user's site is never allowed.
- For the faults requiring radical disassembly and bending operation of the heat exchanger, such as the replacement of the outdoor unit chassis and integral disassembly of the condenser, inspection and maintenance at the user's site are never allowed.
- For the faults requiring replacement of the compressor or parts & components of refrigeration system, maintenance at the user's site is not allowed.
- For other faults not involved in the refrigerant container, internal refrigeration pipelines and refrigeration elements, the maintenance at the user's site is allowed, including the cleaning and dredging of the refrigeration system requiring no disassembly of refrigeration elements and no welding.
- In case replacement of gas/liquid pipes is required during maintenance, the joint of evaporator gas/liquid pipes of the indoor unit shall be cut off with a cutting knife. Connection is only allowed after re-flaring (the same to the outdoor unit).

Qualification Requirements of Maintenance Personnel

1. All the operators or the maintenance personnel involved in refrigerating circuits shall be provided with the effective certificate issued by an industry-accepted assessment institute, to ensure that they are qualified for safety disposal of refrigerant as required in the assessment regulations.
2. The equipment can only be maintained and repaired as per the method recommended by the manufacturer. In case the assistance from personnel of other disciplines is required, the assistance shall be supervised by the personnel with qualification certificate involved in flammable refrigerant.

Inspection on Maintenance Environment

- Before operation, the refrigerant leaked in the room is not allowed.
- The area of the room in which maintenance is made shall be in line with this manual.
- Continuous ventilation shall be maintained during maintenance.
- Open fire or high-temperature heat source higher than 548 degree which can easily give birth to open fire is not allowed inside the room within the maintenance area.
- During maintenance, the phones and the radioactive electronics of all the operators inside the room must be powered off.
- One dry powder or carbon dioxide extinguisher shall be equipped inside the maintenance area, and the extinguisher must be under available state.

Maintenance Site Requirements

- The maintenance site shall be provided with favorable ventilation and must be flat. Arrangement of the maintenance site inside the basement is not allowed.
- Welding zone and non-welding zone shall be divided at the maintenance site, and shall be clearly marked. A certain safety distance must be guaranteed between the two zones.
- Ventilators shall be installed at the maintenance site, and exhaust fans, fans, ceiling fans, floor fans and dedicated exhaust duct can be arranged, to meet the requirements of ventilation volume and uniform exhaust, and to avoid accumulation of refrigerant gas.
- Leak detection equipment for flammable refrigerant shall be equipped, with relevant management system being established. Whether the leak detection equipment is under available state shall be confirmed before maintenance.
- Sufficient dedicated vacuum pumps of flammable refrigerant and refrigerant charging equipment shall be equipped, with relevant management system for maintenance equipment being established. It shall be guaranteed that the maintenance equipment can only be used for vacuumizing and charging of one type of flammable refrigerant, and mixed usage is not allowed.
- The master power switch shall be arranged outside the maintenance site, with protective (anti-explosive) device being equipped.
- Nitrogen cylinders, acetylene cylinders and oxygen cylinders shall be placed separately. The distance between the gas cylinders above and the working area involved in open fire shall be at least 6m. The anti-backfire valve shall be installed for the acetylene cylinders. The color of the acetylene cylinders and oxygen cylinders installed shall meet the international requirements.
- The warning sign of " No Fire" ,"No Smoking", or"Anti static"shall be arranged inside the maintenance area.
- Fire control device suitable for electric appliance such as the dry powder extinguisher or carbon dioxide extinguisher shall be equipped, and shall always be under the available state.
- The ventilator and other electrical equipment at the maintenance site shall be relatively fixed, with standardized pipe routing. Temporary wires and sockets at the maintenance site are not allowed.

Leak Detection Methods

- The environment in which the refrigerant leakage is checked shall be free from potential ignition source. Leak detection with halogen probes (or any other detector with open fire) shall be avoided.
- For the system containing flammable refrigerant, leak detection may be realized with electronic leak detection equipment. During leak detection, the environment in which the leak detection equipment is calibrated shall be free from refrigerant. It shall be guaranteed that the leak detection equipment will not become potential ignition source, and is applicable to the refrigerant to be detected. Leak detection equipment shall be set at a percentage of the LFL of the refrigerant and shall be calibrated to the refrigerant employed, and the appropriate percentage of gas (25 % maximum) is confirmed.
- The fluid used for leak detection shall be applicable to most of the refrigerant. The use of chlorine-containing solvent shall be avoided, to avoid chemical reaction between chlorine and refrigerant and corrosion to copper pipelines.
- In case leakage is suspected, the open fire at the site shall be evacuated or be put out.
- In case welding is required at the leakage position, all the refrigerants shall be recovered, or be isolated at a position far from the leak point with a stop valve. Before and during welding, the whole system shall be purified with OFN.

Safety Principles

- The power supply should be cut off before the maintenance.
- During product maintenance, favorable ventilation shall be guaranteed at the maintenance site, and the close of all the doors/windows is not allowed.
- Operation with open fire is not allowed, including welding and smoking. The use of phones is also not allowed. The user shall be informed that cooking with open fire is not allowed.
- During maintenance in a dry season, when the relative humidity is less than 40%, anti-static measures shall be taken, including the wearing of cotton clothes and cotton gloves.
- In case the leakage of flammable refrigerant is identified during maintenance, forced ventilation measures shall be taken immediately, and the source of leak shall be plugged.
- In case the product damaged must be maintained by disassembling the refrigeration system, the product must be delivered to the maintenance point. Welding of refrigerant pipelines at the user's site is not allowed.
- During maintenance, in case re-treatment is required due to lack of fittings, the air conditioner shall be reset.
- The refrigeration system must be safely earthed in the whole course of maintenance.
- For the door-to-door service with refrigerant cylinders, the refrigerant charged inside the cylinder cannot exceed the specified value. The cylinder placed in vehicles or at the installation/maintenance site shall be fixed perpendicularly and be kept away from heat sources, ignition source, source of radiation and electric appliance.

Maintenance Requirements

- Before the refrigeration system is operated, the circulating system shall be cleaned with nitrogen. Afterwards, the outdoor unit shall be vacuumized, the duration of which cannot be less than 30 minutes. Finally, 1.5~2.0MPa OFN shall be used for nitrogen flushing (30 seconds~1 minute), to confirm the position requiring treatment. Maintenance of the refrigeration system is only allowed after the residual gas of flammable refrigerant is removed.
- During the use of refrigerant charging tools, cross contamination of different refrigerants shall be avoided. The total length (including the refrigerant pipelines) shall be shortened as much as possible, to reduce the residual of refrigerant inside.
- The cylinders of refrigerant shall be kept upright, and be fixed.
- After maintenance of the refrigeration system, the system shall be sealed with a safe manner.
- The maintenance in progress shall not damage or lower the original class of safety protection of the system.

Maintenance of Electrical Components

- Partial of the electrical component under maintenance shall be subject to inspection on refrigerant leakage with dedicated leak detection equipment.
- After the maintenance, the components with safety protection functions cannot be disassembled or removed.
- During the maintenance of sealing elements, before opening the seal cover, the air conditioner shall be powered off first. When power supply is required, continuous leak detection shall be carried out at the most dangerous position, to avoid potential risks.
- During maintenance of electrical components, the replacement of enclosures shall not affect the level of protection.
- After maintenance, it shall be guaranteed that the sealing functions will not be damaged or the sealing materials will not lose the function of preventing the entry of flammable gas due to aging. The substitute components shall meet the recommended requirements of the air conditioner manufacturer.

Maintenance of Intrinsically Safe Elements

- The intrinsically safe element refers to the components working continuously inside flammable gas without any risks.
- Before any maintenance, leak detection and inspection on earthing reliability of the air conditioner must be carried out, to ensure no leakage and reliable earthing.
- In case the allowable voltage and current limit may be surpassed during the service of the air conditioner, any inductance or capacitance cannot be added in the circuit.
- Only the elements appointed by the air conditioner manufacturer can be used as the parts and components replaced, or otherwise a fire or explosion may be triggered in case of refrigerant leakage.
- For the maintenance not involved in system pipelines, the system pipelines shall be well protected, to ensure that no leakage will be caused due to maintenance.
- After maintenance and before test run, the air conditioner must be subject to leak detection and inspection on earthing reliability with leak detection equipment or leak detecting solution. It shall be guaranteed that the startup inspection is carried out without leakage and under reliable earthing.

Removal and Vacuumizing

The maintenance or other operations of the refrigeration circuit shall be made as per conventional procedures. Moreover, the flammability of refrigerant shall also be mainly considered. The following procedures shall be followed:

- Refrigerant cleaning;
- Pipeline purification with inert gas;
- Vacuumizing;
- Pipeline purification again with inert gas;
- Pipeline cutting or welding. The refrigerant shall be recovered to a proper cylinder. The system shall be purged with OFN, to ensure safety. The step above may need to be repeated for several times. Compressed air or oxygen cannot be used for purging.

In the course of purging, OFN shall be charged inside the refrigeration system under vacuum state, to reach the operating pressure. Afterwards, the OFN shall be discharged to the atmosphere. Finally, the system shall be vacuumized. The step above shall be repeated until all the refrigerants in the system are cleared. The OFN charged for the last time shall be discharged to the atmosphere. Afterwards, the system can be welded. The operation above is necessary in case of pipeline welding.

It shall be guaranteed that no alight fire source is around the outlet of the vacuum pump and the ventilation is favorable.

Welding

- Favorable ventilation must be guaranteed in the maintenance area. After the maintenance machine is subject to the vacuumizing above, the system refrigerant can be discharged on the outdoor unit side.
- Before the outdoor unit is welded, it must be guaranteed that no refrigerant is inside the outdoor unit and the system refrigerant has been discharged and cleared.
- The refrigeration pipelines cannot be cut with a welding gun under any circumstance. The refrigeration pipelines must be disassembled with a pipe cutter, and the disassembly must be carried out around a ventilation opening.

Refrigerant Charging Procedures

The following requirements are added as the supplementation of conventional procedures:

- During the use of refrigerant charging tools, cross contamination of different refrigerants shall be avoided. The total length (including the refrigerant pipelines) shall be shortened as much as possible, to reduce the residual of refrigerant inside;
- The cylinders of refrigerant shall be kept upright;
- Before refrigerant charging, the refrigeration system shall be earthed;
- A label must be pasted on the refrigeration system after refrigerant charging;
- Excessive charging is not allowed; the refrigerant shall be charged slowly;
- In case system leakage is identified, refrigerant charging is not allowed unless the leak point is repaired;
- During refrigerant charging, the charging amount shall be measured with an electronic scale or a spring scale. The connecting hose between the refrigerant cylinder and the charging equipment shall be relaxed appropriately, to avoid impact on the measuring accuracy due to stress.

Requirements on storage site of refrigerant

- The cylinder of refrigerant shall be placed in a -10~50 environment with favorable ventilation, and warning labels shall be pasted;
- The maintenance tool in contact with the refrigerant shall be stored and used separately, and the maintenance tool of different refrigerants cannot be mixed.

Scrapping and Recovery

Scrapping

Before scrapping, the technician shall be completely familiar with the equipment and all its features. The safe recovery of refrigerant is recommended. In case the refrigerant recovered needs to be reused, before which the sample of refrigerant and oil shall be analyzed.

(1) The equipment and operation shall be well known;

(2) Power supply shall be switched off;

(3) The followings shall be guaranteed before scrapping:

The mechanical equipment shall be convenient for operation on the cylinder of refrigerant (if necessary);

All personal protective equipment is available and being used correctly;

The whole course of recovery shall be guided by qualified personnel;

The recovery equipment and cylinders shall be in line with corresponding standards.

(4) The refrigeration system shall be vacuumized if possible;

(5) In case the vacuum state cannot be reached, vacuumizing shall be carried out from numerous positions, to pump the refrigerant in each part of the system out;

(6) It shall be guaranteed that the capacity of cylinders is sufficient before recovery;

(7) The recovery equipment shall be started and operated as per the operation instructions of the manufacturer;

(8) The cylinder cannot be charged too full. (The refrigerant charged cannot exceed 80% of the capacity of cylinders)

(9) The maximum operating pressure of cylinders cannot be surpassed even only lasting for a short term;

(10) After refrigerant recovery is completed, the cylinder and equipment must be evacuated rapidly, and all the stop valves on the equipment must be closed;

(11) Before purification and tests, the refrigerant recovered cannot be charged into another refrigeration system.

Note:

The air conditioner shall be marked (with dates and signature) after being scrapped and the refrigerant is discharged. It shall be guaranteed that the sign on the air conditioner can reflect the flammable refrigerant charged inside.

During maintenance or scrapping, the refrigerant inside the refrigeration system needs to be cleared. It is recommended that the refrigerant be cleared thoroughly.

The refrigerant can only be charged into a dedicated cylinder, the capacity of which shall match with the refrigerant amount charged in the whole refrigeration system. All cylinders to be used are designated for the recovered refrigerant and labeled for that refrigerant (Dedicated Cylinder for Refrigerant Recovery). The cylinders shall be equipped with pressure relief valves and stop valves under favorable state. The empty cylinder shall be vacuumized before usage and be kept under normal temperature.

The recovery equipment shall always be under favorable working state, and be equipped with operation instructions, to facilitate information search. The recovery equipment shall be applicable to the recovery of flammable refrigerant. Moreover, weighing apparatus under available state with measurement certificates shall be equipped. In addition, removable attachment joints free from leakage shall be used as the hose, and shall always be under favorable state. Whether the recovery equipment is under favorable state and is properly maintained and whether all the electrical components are sealed shall be checked before usage, to avoid fire or explosion in case of refrigerant leakage. If you have any question, please consult the manufacturer.

The refrigerant recovered shall be delivered back to the manufacturer in appropriate cylinders, with transporting instructions being attached. Mixing of refrigerant in recovery equipment (especially the cylinders) is not allowed.

During transporting, the space in which the flammable refrigerant air conditioners are loaded cannot be sealed. Anti-static measures shall be taken for the transporting vehicles. Meanwhile, during the transporting, loading and unloading of air conditioners, necessary protective measures shall be taken, to protect the air conditioner from being damaged.

During removal of the compressor or clearing of the compressor oil, it shall be guaranteed that the compressor is vacuumized to a proper level, to ensure no residual flammable refrigerant is left inside the lubricating oil. The vacuumizing shall be completed before the compressor is delivered back to the manufacturer. The vacuumizing can only be accelerated by heating the compressor housing through electrical heating. Safety shall be guaranteed when the oil is discharged from the system. Disassembled with a pipe cutter, and the disassembly must be carried out around a ventilation opening

Carefully read the following information in order to operate the air conditioner correctly. Below are listed three kinds of Safety Precautions and Suggestions.

⚠WARNING Incorrect operations may result in severe consequences of death or serious injuries.

⚠CAUTION Incorrect operations may result in injuries or machine damages; in some cases may cause serious consequences.

INSTRUCTIONS: These information can ensure the correct operation of the machine.

The following safety symbols are used throughout this manual:

⊘ : Indicates an action that must be avoided.







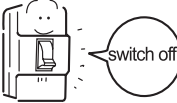

⚠ : Indicates that important instructions must be followed.

⚡ : Indicates a part which must be grounded.

⚡ : Beware of electric shock (This symbol is displayed on the main unit label.)

After completing installation, test the unit to check for installation errors. Give the user adequate instructions concerning the use and cleaning of the unit according to the Operation Manual.

Be sure to conform with the following important Safety Precautions.

⚠WARNING	
<ul style="list-style-type: none"> If any abnormal phenomena is found (e. g. smell of firing), please open the window and well ventilated the room immediately, then cut off the power supply immediately, and contact the dealer to find out the handling method. 	<ul style="list-style-type: none"> Don't dismantle the outlet of the outdoor unit. The exposure of fan is very dangerous which may harm human beings. 
<ul style="list-style-type: none"> In such case, to continue using the conditioner will damage the conditioner, and may cause electrical shock, fire, or explosion hazard. 	<ul style="list-style-type: none"> When need maintenance and repairment, call dealer to handle it. Incorrect maintenance and repairment may cause water leak, electrical shock, fire, and explosion hazard. 
<ul style="list-style-type: none"> After a long time use of air-conditioner, the base should be checked for any damages. If the damaged base is not repaired, the unit may fall down and cause accidents. 	<ul style="list-style-type: none"> Air-conditioner can't be installed in the environment with inflammable gases because the inflammable gases near air-conditioner may cause fire and explosion hazard.
<ul style="list-style-type: none"> No goods or nobody is permitted to placed on or stand on outdoor unit. The falling of goods and people may cause accidents. 	<ul style="list-style-type: none"> Please let the dealer be responsible for installing the conditioner. Incorrect installation may cause water leak, electrical shock, fire, and explosion hazard.
<ul style="list-style-type: none"> Don't operate the air-conditioner with damp hands. Otherwise it will be shocked. 	<ul style="list-style-type: none"> Call the dealer to take measures to prevent the refrigerant from leaking. If conditioner is installed in a small room, be sure to take every measure in order to prevent suffocation and explosion accident even in case of refrigerant leakage.
<ul style="list-style-type: none"> Only use correctly-typed fuse. May not use wire or any other materials replacing fuse, otherwise it may cause faults or fire accidents. 	<ul style="list-style-type: none"> When conditioner is installed or reinstalled, the dealer should be responsible for them. Incorrect installation may cause water leaking, electrical shock, fire, and explosion hazard.
<ul style="list-style-type: none"> Use drain pipe correctly to ensure efficient drainage. Incorrect pipe use may cause water leaking. 	<ul style="list-style-type: none"> Connect earthing wire. Earthing wire should not be connected to the gas pipe, water pipe, lightning rod or phone line, incorrect earthing may cause shock. 
<ul style="list-style-type: none"> Have the unit professionally installed. Improper installation by an unqualified person may result in water leak, electric shock, fire, or explosion. 	<ul style="list-style-type: none"> Installed explosion-proof electrical-leaking circuit breaker. It easily cause electrical shock without circuit breaker.
<ul style="list-style-type: none"> Be sure to carefully follow each step in this handbook when installing the unit. Improper installation may result in water leak, electric shock, smoke or fire. 	<ul style="list-style-type: none"> Be sure to carefully follow each step in this handbook when installing the unit. Improper installation may result in water leak, electric shock, smoke or fire.

⚠WARNING

<ul style="list-style-type: none"> Place the unit on a stable, level surface that withstands the weight of the unit to prevent the unit from tipping over or falling causing injury as a result. 	<ul style="list-style-type: none"> Be sure to carefully follow each step in this handbook when installing the unit. Improper installation may result in water leak, electric shock, smoke or fire.
<ul style="list-style-type: none"> Only use specified cables for wiring. Securely connect each cable, and make sure that the cables are not straining the terminals. Cables not connected securely and properly may generate heat and cause fire and explosion. 	<ul style="list-style-type: none"> Have all electrical work performed by a licensed electrician according to the local regulations and the instructions given in this manual. Secure a circuit designated exclusively to the unit. Improper installation or a lack of circuit capacity may cause the unit to malfunction or present a risk of electric shock, smoke, and fire.
<ul style="list-style-type: none"> Take necessary safety measures against typhoons and earthquakes to prevent the unit from falling over. 	<ul style="list-style-type: none"> Securely attach the terminal cover(panel) on the unit. If installed improperly, dust and/or water may enter the unit and present a risk of electric shock, smoke, fire, or explosion.
<ul style="list-style-type: none"> Do not make any changes or modifications to the unit. In case of problems, consult the dealer. If repairs are not made properly, the unit may leak water and present a risk of electric shock, or it may produce smoke or cause fire and explosion. 	<ul style="list-style-type: none"> Only use refrigerant R32 as indicated on the unit when installing or relocating the unit. The use of any other refrigerant or an introduction of air into the unit circuit may cause the unit to run an abnormal cycle and abnormal cycle and cause the unit to burst.
<ul style="list-style-type: none"> Do not touch the fins on the heat exchanger with bare hands, for they are sharp and dangerous. 	<ul style="list-style-type: none"> When installing the unit in a small room, safeguard against hypoxia that results from leaked refrigerant reaching the threshold level. Consult the dealer for necessary measures to take.
<ul style="list-style-type: none"> In the event of a refrigerant gas leak, provide adequate ventilation to the room. If leaked refrigerant gas is exposed to a heat source, noxious gases, fire or explosion will be caused. 	<ul style="list-style-type: none"> When relocating the air conditioner, consult the dealer or a specialist. Improper installation may result in water leak, electric shock, or fire.
<ul style="list-style-type: none"> Do not try to defeat the safety features of the devices, and do not change the settings. Defeating the safety features on the unit such as the pressure switch and temperature switch or using parts other than the dealer or specialist may result in fire or explosion. 	<ul style="list-style-type: none"> After completing the service work, check for a refrigerant gas leak. If leaked gas refrigerant is exposed to a heat source such as fan heater, stove, and electric grill, noxious gases may form.
<ul style="list-style-type: none"> Only use specified parts. Have the unit professionally installed. Improper installation may cause water leak, electric shock, smoke, fire, explosion. 	<ul style="list-style-type: none"> After completing the service work, check for a refrigerant gas leak. If leaked gas refrigerant is exposed to a heat source such as fan heater, stove, and electric grill, noxious gases may form.

Precautions for Handling Units for Use with R32

⚠CAUTION	
<p>Do not use the existing refrigerant piping</p> <ul style="list-style-type: none"> • The old refrigerant and refrigerator oil in the existing piping contain a large amount of chlorine, which will cause the refrigerator oil in the new unit to deteriorate. • R32 is a high-pressure refrigerant, and the use of the existing piping may result in bursting. 	<p>Use a vacuum pump with a reverse-flow check valve.</p> <ul style="list-style-type: none"> • If other types of valves are used, the vacuum pump oil will flow back into the refrigerant cycle and cause the refrigerator oil to deteriorate.
<p>Keep the inner and outer surfaces of the pipes clean and free of contaminants such as sulfur, oxides, dust/dirt shaving particles, oils, and moisture.</p> <ul style="list-style-type: none"> • Contaminants inside the refrigerant piping will cause the refrigerant oil to deteriorate. 	<p>Do not use the following tools that have been used with the conventional refrigerants. Prepare tools that are for exclusive use with R32. (Gauge manifold, charging hose, gas leak detector, reverse-flow check valve, refrigerant charge base, vacuum gauge, and refrigerant recovery equipment.)</p> <ul style="list-style-type: none"> • If refrigerant and/or refrigerant oil left on these tools are mixed in with R32, or if water is mixed with R32, it will cause the refrigerant to deteriorate. • Since R32 does not contain chlorine, gas-leak detectors for conventional refrigerators will not work.
<p>Store the piping to be used during installation indoors, and keep both ends of the piping sealed until immediately before brazing. (Keep elbows and other joints wrapped in plastic.)</p> <ul style="list-style-type: none"> • If dust, dirt, or water enters the refrigerant cycle, it may cause the oil in the unit to deteriorate or may cause the compressor to malfunction. 	<p>Do not use a charging cylinder.</p> <ul style="list-style-type: none"> • The use of charging cylinder will change the composition of the refrigerant and lead to power loss.
<p>Use a small amount of ester oil, ether oil, or alkylbenzene to coat flares and flange connections.</p> <ul style="list-style-type: none"> • A large amount of mineral oil will cause the refrigerating machine oil to deteriorate. 	<p>Exercise special care when handling the tools.</p> <ul style="list-style-type: none"> • An introduction of foreign objects such as dust, dirt or water into the refrigerant cycle will cause the refrigerating machine oil to deteriorate.
<p>Use liquid refrigerant to charge the system.</p> <ul style="list-style-type: none"> • Charge the unit with gas refrigerant will cause the refrigerant in the cylinder to change its composition and will lead to a drop in performance 	<p>Only use R32 refrigerant.</p> <ul style="list-style-type: none"> • The use of refrigerants containing chlorine (i.e. R22) will cause the refrigerant to deteriorate.

Before Installing the Unit

⚠CAUTION	
<p>Do not install the unit in a place where there is a possibility of flammable gas leak.</p> <ul style="list-style-type: none"> • Leaked gas accumulated around the unit may start a fire or explosion. 	<p>When installing the unit in a hospital, take necessary measures against noise.</p> <ul style="list-style-type: none"> • High-frequency medical equipment may interfere with the normal operation of the air conditioning unit or the air conditioning unit may interfere with the normal operation of the medical equipment
<p>Do not use the unit to preserve food, animals, plants, artifacts, or for other special purposes.</p> <ul style="list-style-type: none"> • The unit is not designed to provide adequate conditions to preserve the quality of these items. 	<p>Do not place the unit on or over things that may not get wet.</p> <ul style="list-style-type: none"> • When humidity level exceeds 80% or when the drainage system is clogged, indoor units may drip water. • Installation of a centralized drainage system for the outdoor unit may also need to be considered to prevent water drips from the outdoor units.
<p>Do not use the unit in an unusual environment</p> <ul style="list-style-type: none"> • The use of the unit in the presence of a large amount of oil, steam, acid, alkaline solvents or special types of sprays may lead to a remarkable drop in performance and/or malfunction and presents a risk of electric shock, smoke, fire, or explosion. • The presence of organic solvents, corroded gas (such as ammonia, sulfur compounds, and acid may cause gas or water leak.) 	

Before Installing (Relocating) the Unit or Performing Electric Work

⚠CAUTION	
<p>Ground the unit.</p> <ul style="list-style-type: none"> Do not connect the grounding on the unit to gas pipes, water pipes, lightning rods, or the grounding terminals of telephones. Improper grounding presents a risk of electric shock, smoke, fire, explosion, or the noise caused by improper grounding may cause the unit to malfunction. 	<p>Do not spray water on the air conditioners or immerse the air conditioners in water.</p> <ul style="list-style-type: none"> Water on the unit presents a risk of electric shock.
<p>Make sure the wires are not subject to tension.</p> <ul style="list-style-type: none"> If the wires are too taut, they may break or generate heat and/or smoke and cause fire or explosion. 	<p>Periodically check the platform on which is placed for damage to prevent the unit from falling.</p> <ul style="list-style-type: none"> If the unit is left on a damaged platform, it may topple over, causing injury.
<p>Install a breaker for current leakage at the power source to avoid the risk of electric shock.</p> <ul style="list-style-type: none"> Without a breaker for current leakage, there is a risk of electric shock, smoke or fire. 	<p>When installing draining pipes, follow the instructions in the manual, and make sure that they properly drain water so as to avoid dew condensation.</p> <ul style="list-style-type: none"> If not installed properly, they may cause water leaks and damage the furnishings.
<p>Use breakers and fuses (electrical current breaker, remote switch<switch+Type-B fuse>, molded case circuit breaker) with a proper current capacity.</p> <ul style="list-style-type: none"> The use of large-capacity fuses, steel wire, or copper wire may damage the unit or cause smoke or fire. 	<p>Properly dispose of the packing materials.</p> <ul style="list-style-type: none"> Things such as nails may be included in the package. Dispose of them properly to prevent injury. Plastic bags present a choking hazard to children. Tear up the plastic bags before disposing of them to prevent accidents.

Before the Test Run

⚠CAUTION	
<p>Do not operate switches with wet hands to avoid electric shock.</p> <p>Do not touch the refrigerant pipes with bare hands during and immediately after operation.</p> <ul style="list-style-type: none"> Depending on the state of the refrigerant in the system, certain parts of the unit such as the pipes and compressor may become very cold or hot and may subject the person to frost bites or burning. 	<p>Do not turn off the power immediately after stopping the unit.</p> <ul style="list-style-type: none"> Allow for at least five minutes before turning off the unit, otherwise the unit may leak water or experience other problems.
<p>Do not operate the unit without panels and safety guards in their proper places.</p> <ul style="list-style-type: none"> They are there to keep the users from injury for accidentally touching rotating, high-temperature or high-voltage parts. 	<p>Do not operate the unit without air filters.</p> <ul style="list-style-type: none"> Dust particles in the air may clog the system and cause malfunction.

14.2 Introduction

General information

Important note: Please, check, according to the model name, which is your heat pump type, how it is abbreviated and referred to in this instruction manual. This Installation and Operation Manual is only related to AU052FYCRA(HW) AU082/112/162FYCRA(HW) outdoor Units.

A range of air/water reversible heat pumps with inverter technology. The mono-phase versions are available with AU052FYCRA(HW) AU082/112/162FYCRA(HW) models to fulfil central heating and cooling requirements for homes, offices, shops, etc...;

These appliances are distinguished for their high energy efficiency and contained sound levels. They can be used as a single generator to assist the system, but also inside an integrated system (for example, with a heat pump - boiler - solar heating). They are engineering solutions that can be perfectly integrated with each other, which allow to attain maximum benefit from the various energy production systems on the basis of the respective efficiency parameters.

For the entire system to operate correctly, HAIER offers an "intelligent" system Manager capable of identifying the most economical energy source at a given time and therefore choose the right appliance to activate.

All series models are equipped with a system low energy consumption circulation pump, The maximum flow temperature set-point with central heating is 60°C, which enables application of radiator systems as well as fan coil or radiant systems. The entire range complies with the requirements of ErP Directive (2009/125/EC) and ELD (2010/30/EC). Various hydraulic, electric and electronic kits are available, which enable flexible use in all circumstances 5kW mono-phase inverter air/water heat pumps for winter and summer air conditioning. Plate heat exchanger is applied for AU052FYCRA(HW).

All series models are equipped with a system side plate heat exchanger and low energy consumption circulation pump, which facilitate installation. The maximum flow temperature set-point with central heating is 55°C, which enables use of radiator systems as well as fan coil or radiant systems. The entire range complies with the requirements of ErP Directive (2009/125/EC) and ELD (2010/30/EC). Various hydraulic, electric and electronic kits are available, which enable flexible use in all circumstances 8kW, 11kW and 16kW mono-phase inverter air/water heat pumps for winter and summer air conditioning. The tube in 8kW and the shell-tube in 11 and 16 kW..

Combination and options





Digital I/O PCB kit (option), type is ATW-A01

An optional I/O PCB can be connected to the 3 indoor unit and allows:



- Remote alarm output
- Heating/cooling ON/OFF output bivalent operation (permission signal for the auxiliary boiler)
- Refer to the operation manual and to the installation manual of the digital I/O PCB for more information.
- Refer to the wiring diagram or connection diagram for connecting this PCB to the unit.

Accessories

AU052FYCRA(HW)

No.	Drawing	Name of parts	Quantity
1		Drainage elbow	4
2		Rubber cushion	4
3		Wired-Controller	1
4		Water filter	1

AU052FYCRB(HW)

No.	Drawing	Name of parts	Quantity
1		Drainage elbow	4
2		Rubber cushion	4

AU082/112/162FYCRA(HW)

No.	Drawing	Name of parts	Quantity
1		Drainage elbow	3
2		Rubber cushion	4

Move and scrap the air conditioning

- When moving, to disassemble and re-install the air conditioning, please contact your dealer for technical support.
- In the composition material of air conditioning, the content of lead, mercury, hexavalent chromium, polybrominated biphenyls and polybrominated diphenyl ethers are not more than 0.1% (mass fraction) and cadmium is not more than 0.01% (mass fraction).
- Please recycle the refrigerant before scrapping, moving, setting and repairing the air conditioning; for the air conditioning scrapping, should be dealt with by the qualified enterprises.

14.3 Transportation and lifting

Lifting

In front of the unit shipped from unpacking location as close as possible.

⚠CAUTION

- Do not place anything on the device.
- Two ropes shall be used for lifting the outdoor unit.

Hoisting method

Hoisting to ensure that the level of outdoor machine, slowly lifting.

1. Removal of outer packing is strictly prohibited
2. As shown by two ropes hoist with outdoor machine packaging.

⚠CAUTION

- In order to ensure safety, maintain the level of lifting, slowly lifting.
- Do not lift the elevator to the packing and outer packing of the equipment.
- External protection should be used when lifting, such as cloth or cardboard.

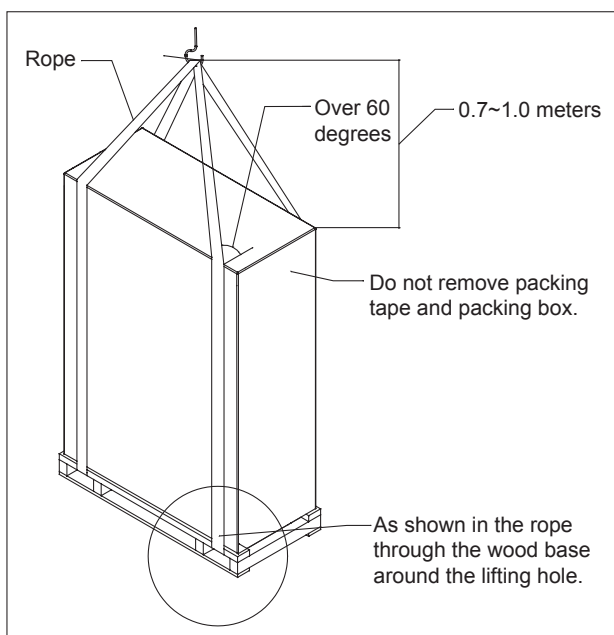

AU052FYCRA(HW)

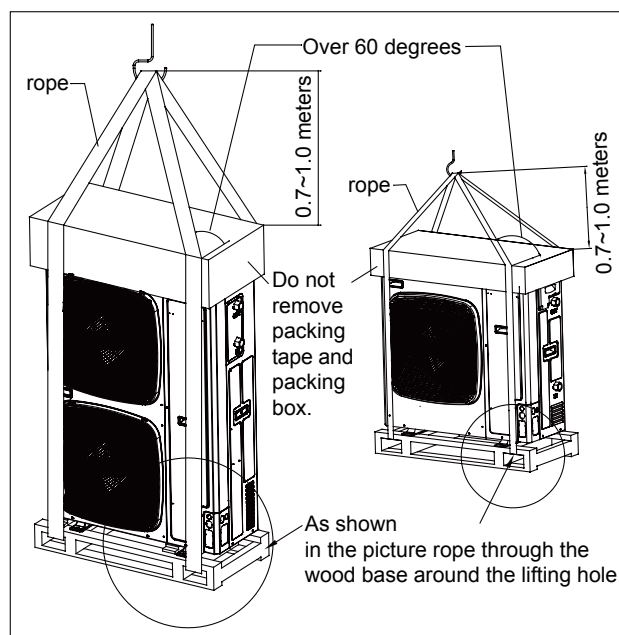

AU082/112/162FYCRA(HW)

Manual handling

⚠ CAUTION

•In the installation and commissioning, the outdoor machine do not put any irrelevant material, to ensure that there is no debris inside the machine, or there may be a fire or accident.

Pay attention to the following points when handling the equipment manually:

- 1.No demolition wood base.
- 2.In order to prevent the dumping of the outdoor machine, the center of gravity of the unit should be noted as shown in the figure.
- 3.Two or more people to carry out the outdoor machine.

AU052FYCRA(HW) AU052FYCRB(HW)

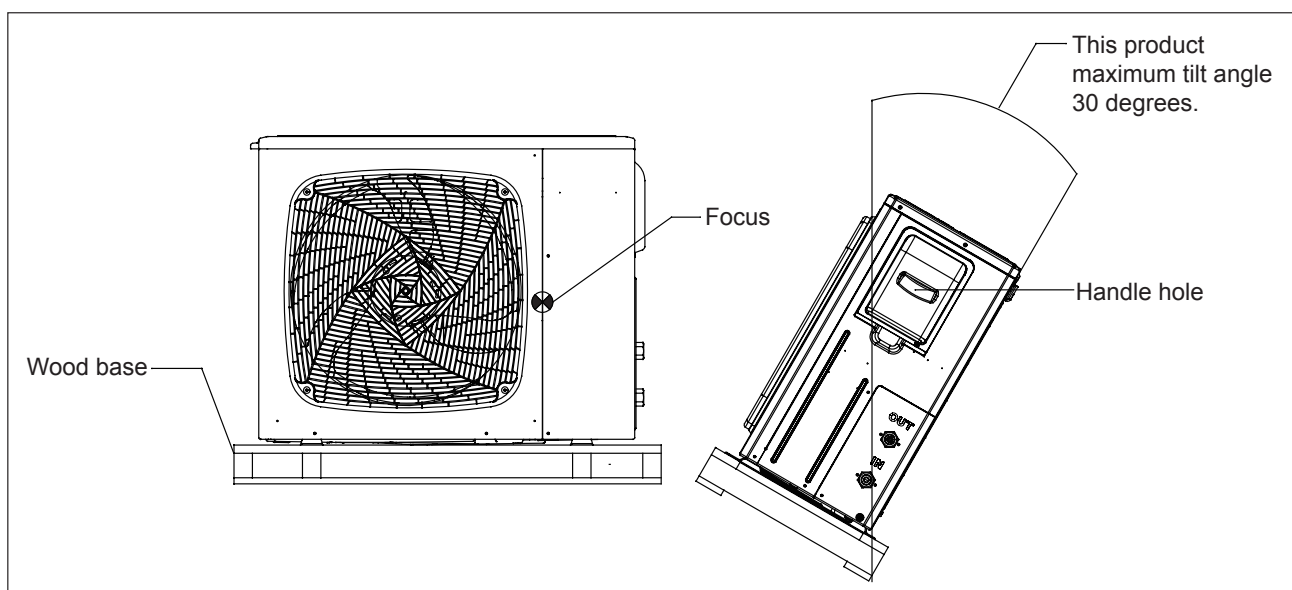

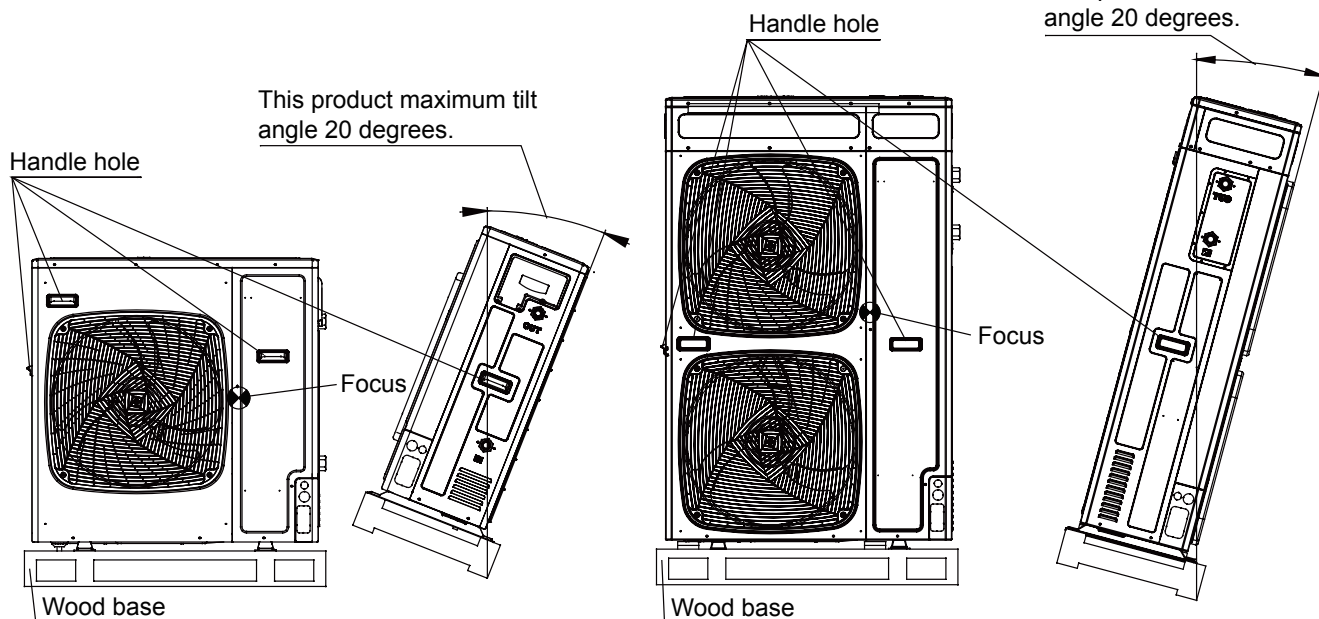

AU082/112/162FYCRA(HW)

This product maximum tilt angle 20 degrees.

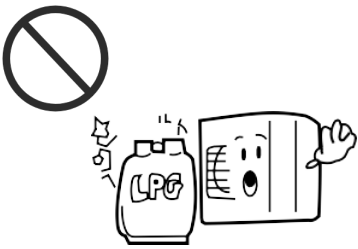
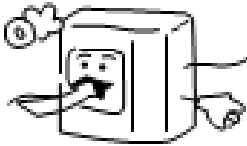
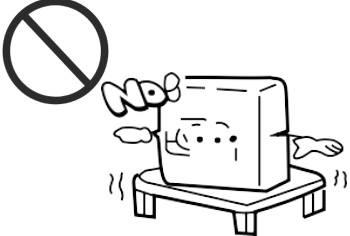

14.4 Installation instruction

(1) Installation place selection

<p>Air-conditioner can't be installed in the place with inflammable gas. Or it will cause fire hazard.</p> 	<p>The unit should be installed at the place with good ventilation. No obstacle at the air inlet/outlet. And no strong wind blows the unit.</p>  <p>The installation space refers to the latter info.</p>	<p>The unit should be installed at the strong enough place. Or it will cause vibration and noise.</p> 
<p>The unit should be installed at the place where the cold/hot air or noise will not interfere the neighbours.</p> 	<ul style="list-style-type: none"> •The place where the water can flow fluently. •The place where no other heat source will affect the unit. •Pay attention to the snow against clogging the outdoor. •In installation, install the anti-vibration rubber between the unit and the bracket. 	<ul style="list-style-type: none"> •The unit is better not be installed at the below places, or it will cause damage. •The place where there is corrosive gas (spa area etc). •The place blowing salty air (seaside etc). •Exsits the strong coal smoke. •The place with high humidity. •The place where there is device emitting Hertzian waves. •The place where voltage changes greatly

Note:

1. In snowy area, install the unit under the bracket or the snow-proof cover against the accumulative snow on the unit.
2. Do not install the unit at the place where the flammable gas will leak.
3. Install the unit at the strong enough place.
4. Install the unit at the flat place.
5. When being installed at the place with strong wind, set the air outlet of the unit and the wind direction vertical.
6. The installation site should be far away from the place where the noise is higher. At the same time for the noise of higher places should ensure that the outdoor machine vibration and wall insulation measures to prevent vibration caused by thin wall or acoustic noise problems.
7. Aluminum foil fin is very sharp, pay attention to prevent scratches.
8. In addition to the maintenance of the roof, or the installation of outdoor machines, other people can not contact the outdoor machine.

(2) Installation and maintenance space

Selection of installation location of outdoor

(1) Single-unit installation (unit: in.(mm))

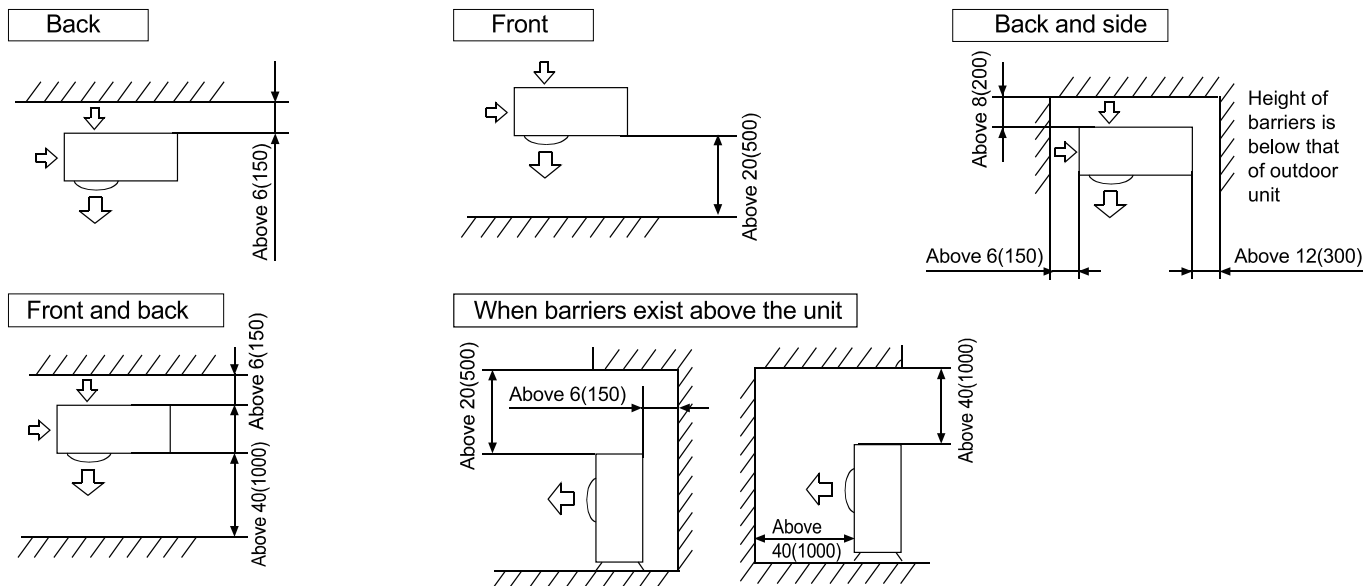

The top and two side surfaces must be exposed to open space, and barriers on at least one side of the front and back shall be lower than the outdoor unit.

(2) Multi-unit installation (unit: in.(mm))

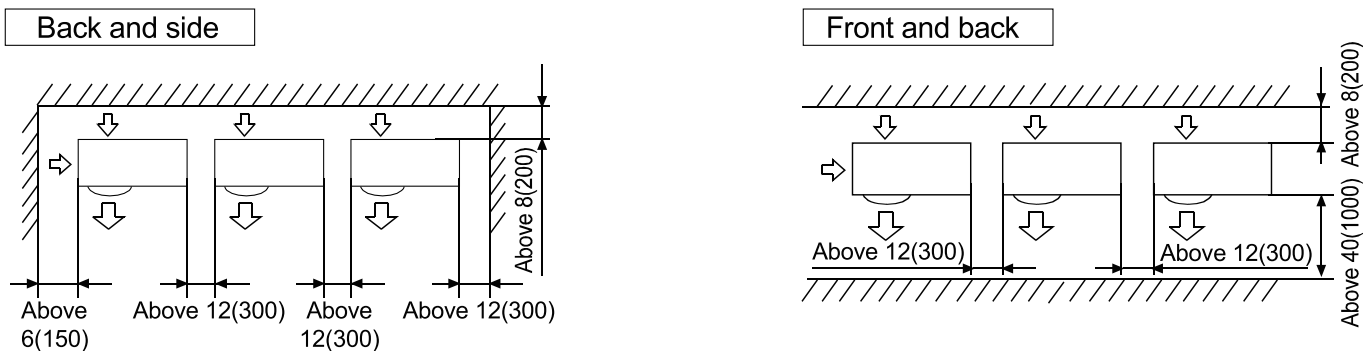

(3) Multi-unit installation in front and back (unit: in.(mm))

Standard

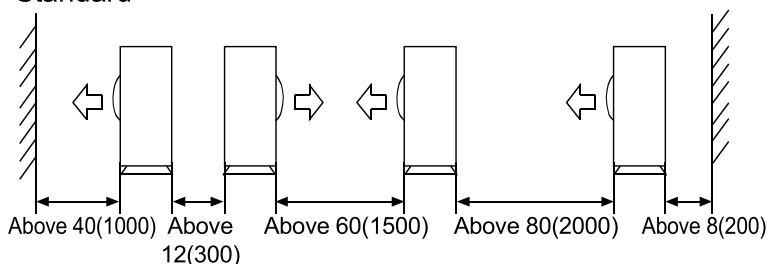

The top and two side surfaces must be exposed to open space, and barriers on at least one side of the front and back shall be lower than the outdoor unit.

- The installation service spaces shown in the illustrations are based on an air intake temperature of 95°F(35°C)(DB) for COOL operation. In regions where the air intake temperature regularly exceeds 95°F(35°C)(DB), or if the heat load of outdoor units is expected to regularly exceed the maximum operating capacity, reserve a larger space than that indicated at the air intake side of units.

- Regarding the required air outlet space, position the units with consideration to the space required for the onsite refrigerant piping work as well. Consult your dealer if the work conditions do not match those in the drawings.

(3)Precautions on installation

NOTICE

If drain holes of the outdoor unit are covered by a mounting base or by floor surface, raise the unit in order to provide a free space of more than 5in.(130mm) under the outdoor unit.

Selection of installation location of outdoor

(1)Single-unit installation (unit: in.(mm))

Foundation work

- Check the strength and level of the installation ground so that the unit will not cause any operating vibration or noise after installation.
- In accordance with the foundation drawing in the figure, fix the unit securely by means of the foundation bolts.
- It is best to screw in the foundation bolts until their length are 0.8in.(20mm) from the foundation surface.
- Fix the outdoor unit to the foundation bolts using nuts with resin washers(1) as shown in the figure.
- If there is no need to install the outdoor machine in the open space of the building or the enclosure, the following two ways can be used to avoid the fan reversal or damage caused by strong wind blowing.

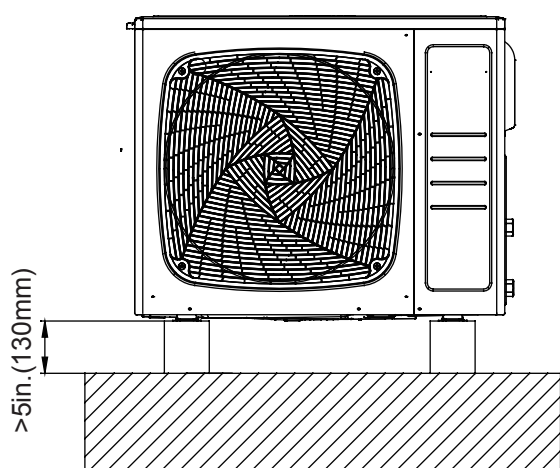

AU052

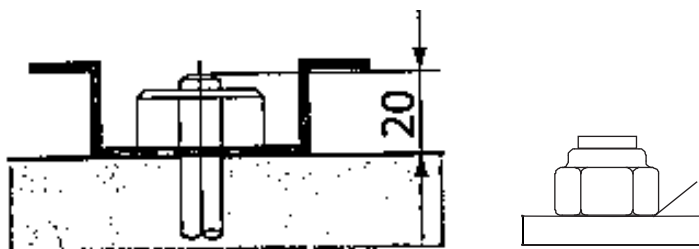
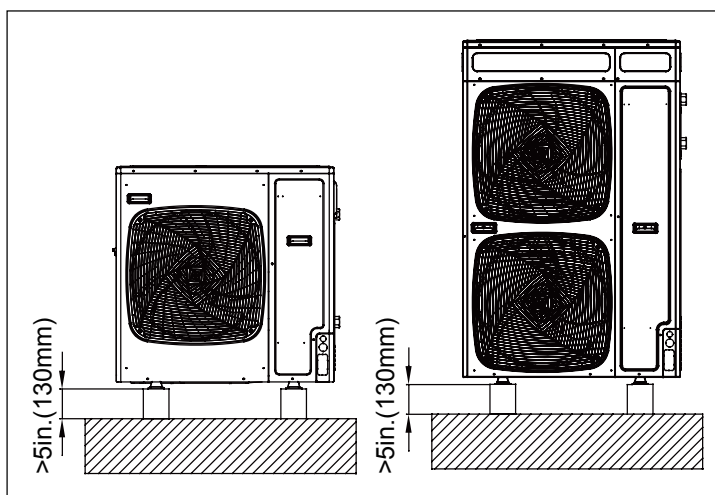

AU052

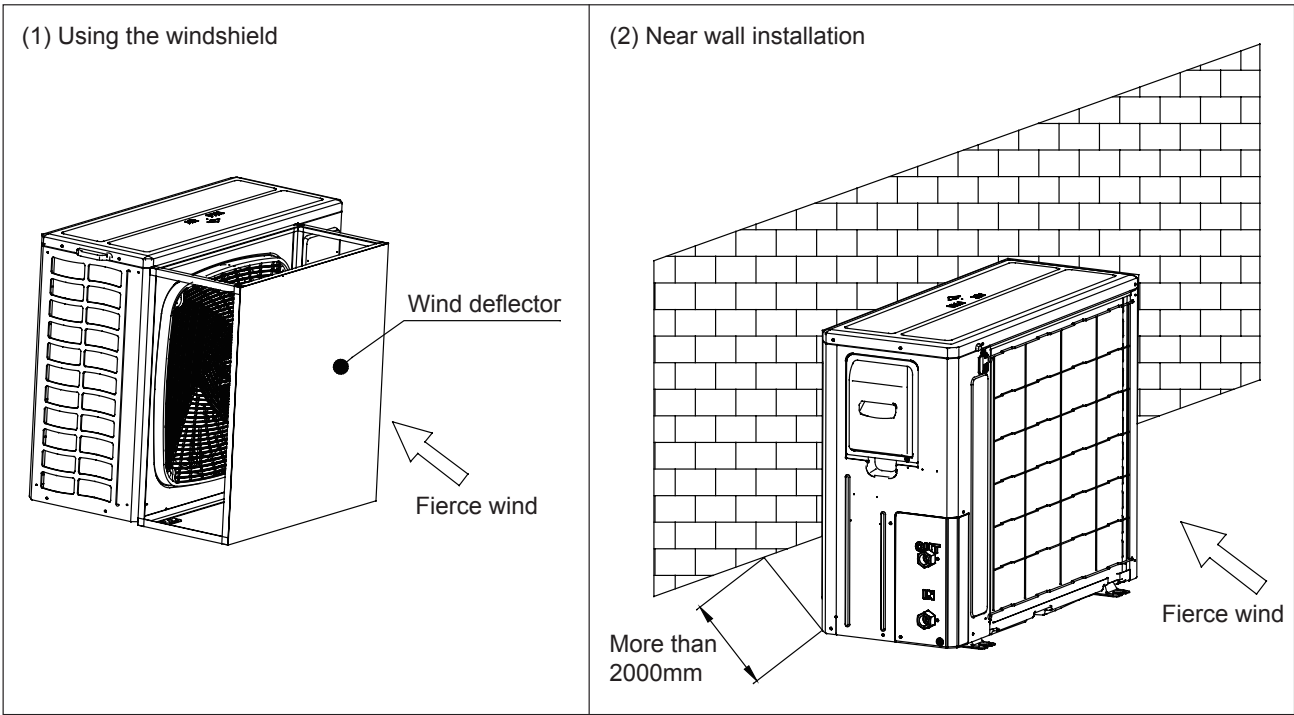

AU082/112/162

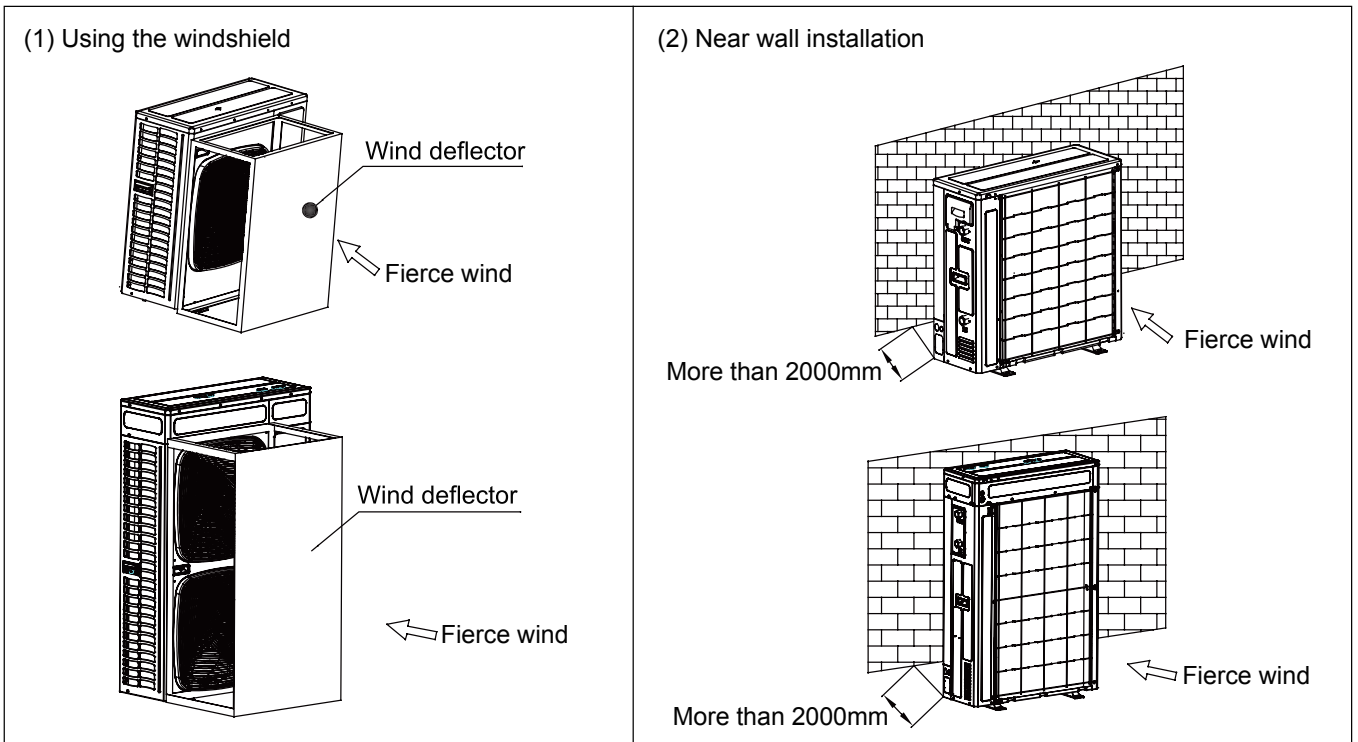

If the coating on the fastening area is stripped off, the nuts rust easily.
Dimensions (bottom view) (unit of measurement: mm)

AU052

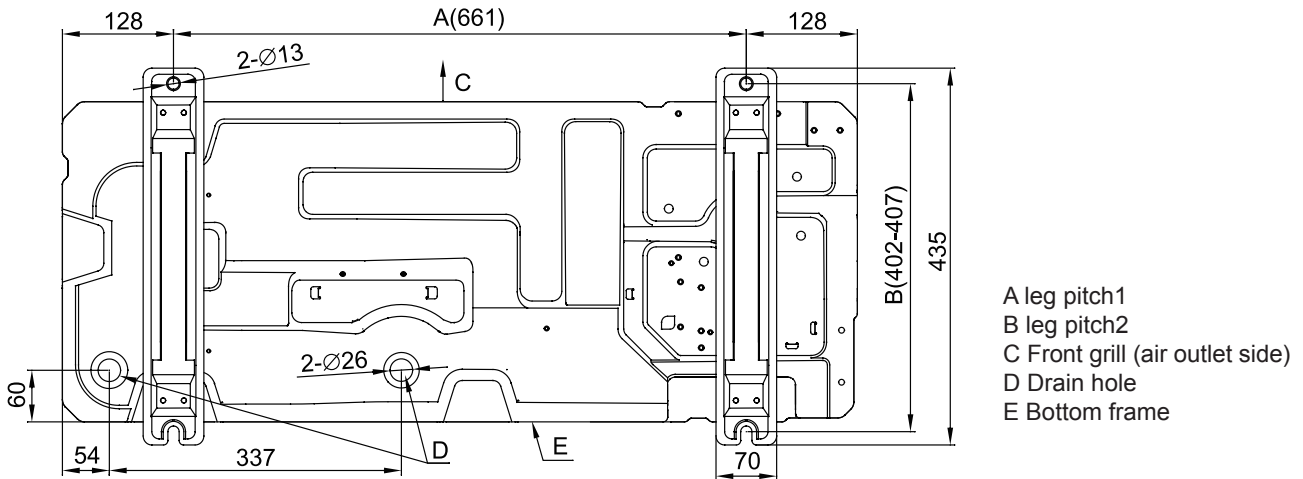

AU082/112/162FYCRA(HW)

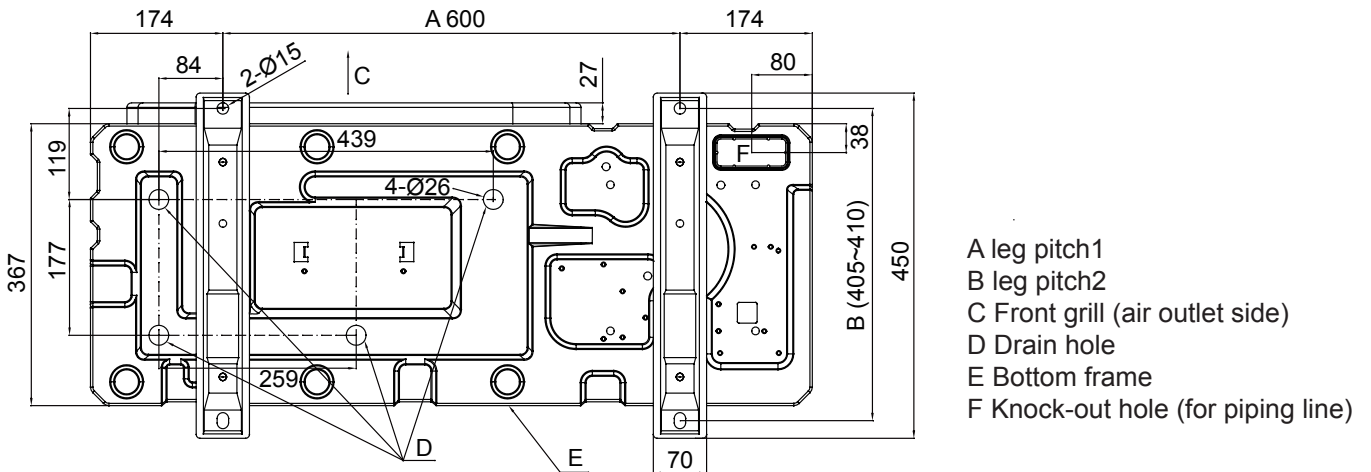

(4) Drain work of the outdoor unit

In case drain work on your outdoor unit is necessary, follow the guidelines below.

- Two drain outlets are provided in the bottom plate of unit (drain plug and drain hose are field supply).
- In cold areas, do not use a drain hose with the unit. Otherwise, drain water may freeze and block the drain. In case the use of a drain hose is unavoidable for one reason or another, it is recommended to install a heater tape in order to protect drain from freezing.
- Make sure the drain works properly.

NOTICE

If drain holes of the outdoor unit are covered by a mounting base or by floor surface, raise the unit in order to provide a free space of more than 100 mm under the outdoor unit.

(5) Requirements and recommendations for the hydraulic circuit

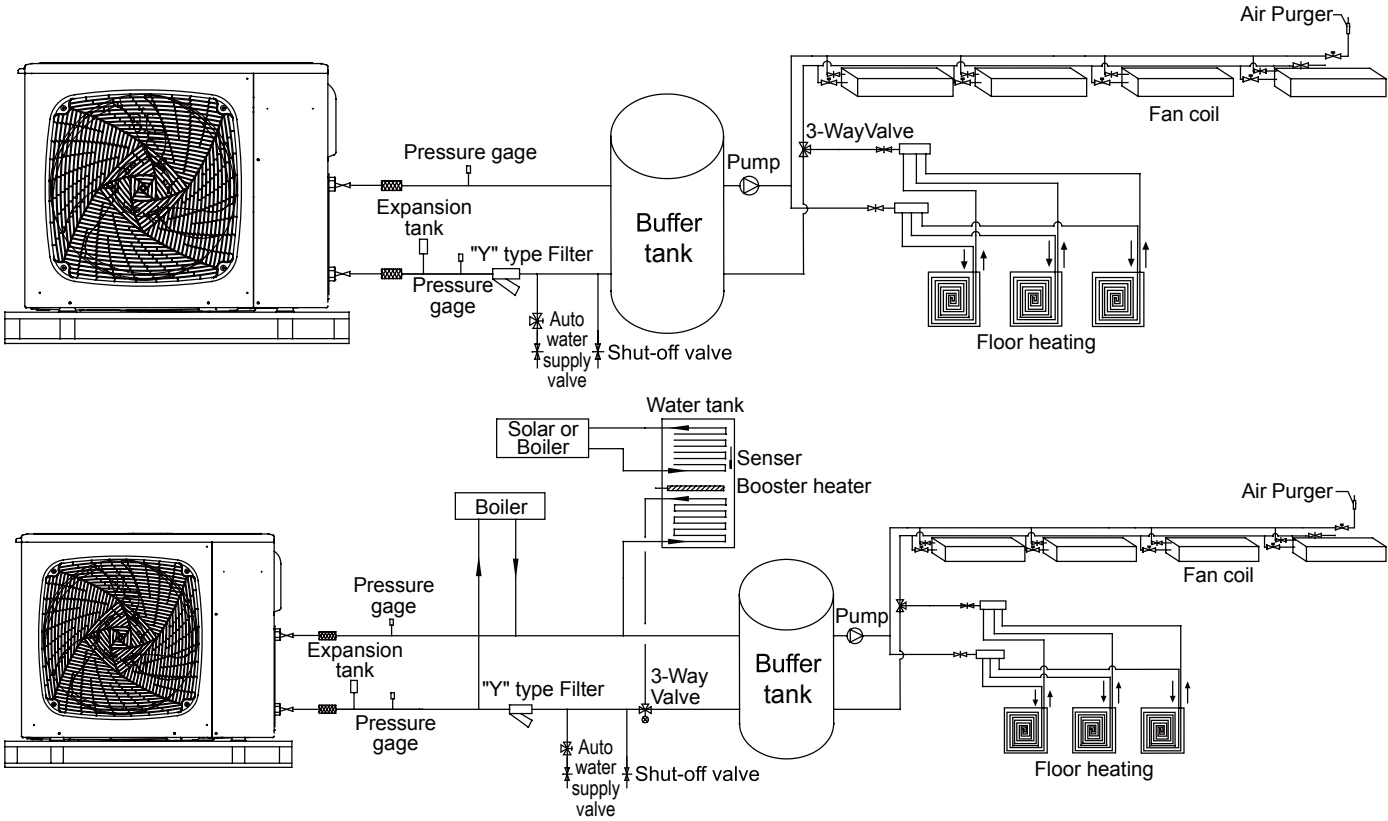

Hydraulic circuit

The maximum piping length depends on the maximum pressure availability in the water outlet pipe. Please check the pump curves.

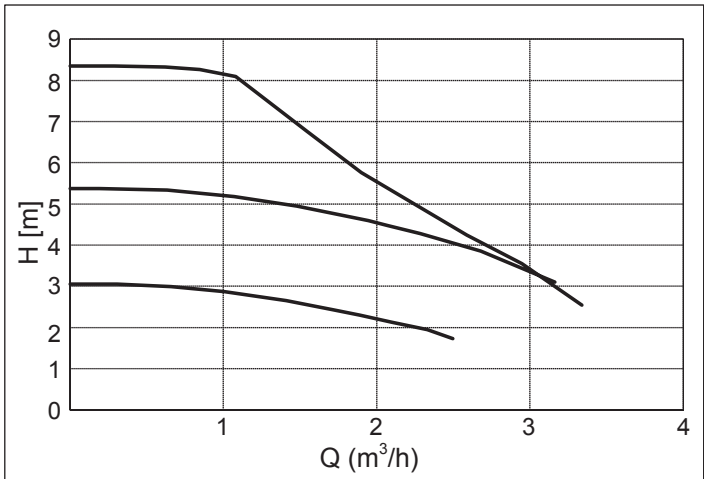

AU052

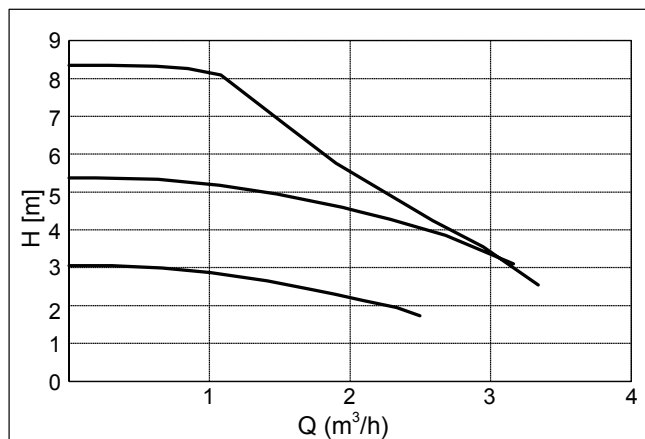

AU082FYCRA(HW)

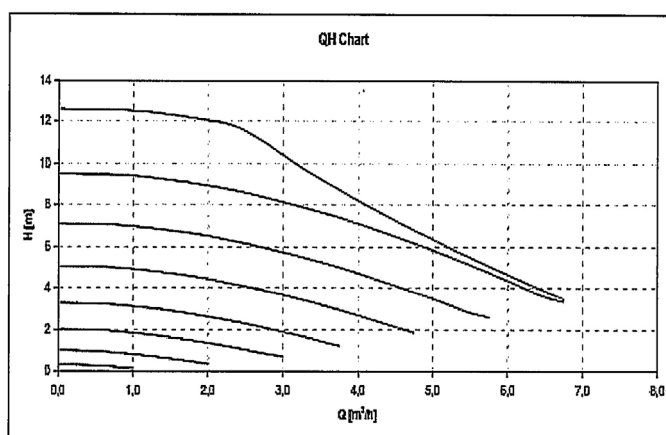

AU112FYCRA(HW)
AU162FYCRA(HW)

Air purging

•The hydraulic system should be equipped with an air purger at the highest location of the system. If this location is not the highest of the water installation, air might be trapped inside the water pipes, which could cause system malfunction. In that case additional air purgers (field supplied) should be installed to ensure no air enters the water circuit. It should be installed as below:

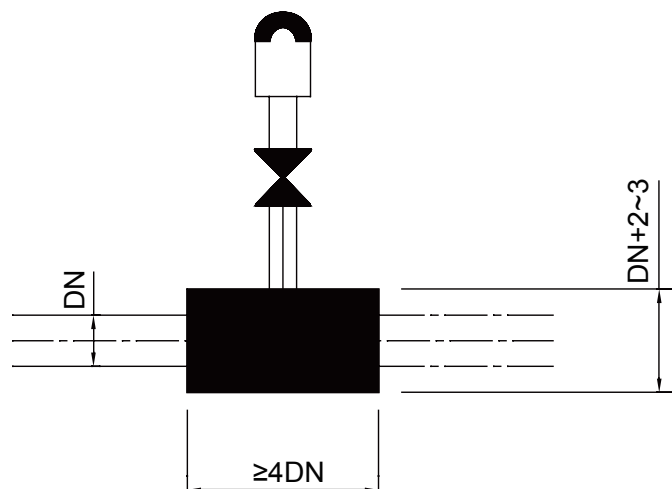

•For heating floor system, the air should be purged by means of an external pump and an open circuit to avoid air bags.

Anti-freezing

•When the unit is stopped during shut-off periods and the ambient temperature is very low, the water inside the pipes and the circulating pump may freeze, thus damaging the pipes and the water pump. In these cases, the installer shall ensure that the water temperature inside the pipes does not fall below the freezing point. In order to prevent this, the unit has a self-protection mechanism which should be activated

•Additionally, in cases where water drainage is difficult, an anti freeze mixture of glycol (ethylene or propylene) should be used (content between 10% to 40%). The performance of the unit working with glycol may decrease in proportion to the percentage of glycol used, since the density of glycol is higher than that of the water.

Minimum flow rate

•Check that the water pump of the space heating circuit works within the pump operating range and that the water flow is over the pump's minimum. If the water flow is below 12 litres/minute (6 litres/minute for AU082 unit), alarm is displayed on the unit.

Filter

•An additional special water filter is highly recommended to be installed on the space heating (field installation), in order to remove possible particles remaining from brazing which cannot be removed by the unit water strainer. Water filter need to be bought and installed by installer. Number of water filter meshes is not less than 40.

Expansion tank

•The internal air pressure of the expansion vessel tank will be adapted to the water volume of the final installation,there is not expansion tank in the ODU,it should be buy and installed by installer.The Volume of the expansion tank is according to the whole system.

DHW Tank

•When selecting a tank for DHW operation, take into consideration the following points:
The storage capacity of the tank has to meet with the daily consumption in order to avoid stagnation of water. Fresh water must circulate inside the DHW tank water circuit at least one time per day during the first days after the installation has been performed. Additionally, flush the system with fresh water when there is no consumption of DHW during long periods of time.

Heat loss

•Try to avoid long runs of water piping between the tank and the ODU installation in order to decrease possible temperature losses.
•When necessary, put insulation on the pipes in order to avoid heat losses. The thickness of insulation is not less than 30mm.

Piping

• The maximum water pressure is 5 bar (nominal opening pressure of the safety valve). Provide adequate reduction pressure device in the water circuit to ensure that the maximum pressure is NOT exceeded.
•Make sure that all field supplied components installed in the piping circuit can withstand the water pressure and the water temperature range in which the unit can operate.
•HAIER units are conceived for exclusive use in a closed water circuit.
•Connector specifications and recommended pipe diameters are as follows

Connector specifications		Recommended pipe diameters	
Model	AU052FYCRA(HW) AU052FYCRB(HW)	Model	AU052FYCRA(HW) AU052FYCRB(HW)
Specifications(inch)	Rc3/4	Pipe diameters(inch)	≥1

Minimum water volume description

The following part shows how to calculate the minimum water volume in the system for product protection (anti-hunting) and temperature drop at defrosting.

1 Protective water volume for product

Ensure that the water volume is equal or greater than those shown below, in order to lower ON/OFF frequency of HAIER unit at no load or extreme light load. When water volume is less than the volume indicated (minimum water volume), compressor operation frequently stops at light load, which should result in shorter life or failure.

Mode	AU052FYCRA(HW) AU052FYCRB(HW)	AU082FYCRA(HW)	AU112FYCRA(HW)	AU162FYCRA(HW)
Minimum water volume(L)	30	40	55	80

Water control

It is necessary to analyse the quality of water by checking pH, electrical conductivity, ammonia ion content, sulphur content, and others. The following is the recommended standard water quality.

For AU052FYCRA(HW) AU052FYCRB(HW)

Content	Item	Concentration mg/L or ppm
Standard Quality pH(25°C)		7.5-9
Electrical conductivity {2}	$\mu\text{S}/\text{cm}$	10-500
Alcalinity	HCO_3^-	70-300
Sulphate	SO_4^{2-}	<70
Alcalinity/Sulphate	$\text{HCO}_3^-/\text{SO}_4^{2-}$	>1
Ammonium	NH_4	<2
Free chlorine	Cl_2	<1
Hydrogen sulfide	H_2S	<0.05
Free carbon dioxide(aggressive)	CO_2	<5
Nitrate	NO_3^-	<100
Iron	Fe	<0.2
Aluminium	Al	<0.2
Manganese	Mn	<0.1
Chloride content	Cl-	≤ 50
Total Hardness	CaCO_3	≤ 70

NOTE

- The mark “” in the table means the factor concerned with the tendency of corrosion or deposits of scales.
- The value showed in “{ }” are for reference only according to the former unit.

Item	Chilled Water System		Tendency	
	Circulating Water (20°C Less than)	Supply Water	Corrosion	Deposits of Scales
Standard Quality pH(25°C)	6.8~8.0	6.8~8.0	•	•
Electrical Conductivity(ms/m) (25°C) (μS/cm) (25°C) {2}	Less than 40 Less than 400	Less than 43 Less than 400	•	•
Chlorine Ion (mg CL ⁻ /l)	Less than 50	Less than 50	•	
Sulphur Acid Ion (mg SO ⁻ /l)	Less than 50	Less than 50	•	
The Amount of Acid Consumption (pH4.8)(mg CaCO ₃ /l)	Less than 50	Less than 50		•
Total Hardness(mg CaCO ₃ /l)	Less than 70	Less than 70		•
Calcium Hardness(mg CaCO ₃ /l)	Less than 50	Less than 50		•
Silica L(mg SO ⁻ /l)	Less than 30	Less than 30		•
Reference Quality Total iron(mg Fe/l)	Less than 1.0	Less than 0.3	•	•
Total Copper(mg Cu/l)	Less than 1.0	Less than 0.1	•	
Sulphur Ion(mg S ₂ -/l)	It shall not be detected		•	
Ammonium Ion(mg NH ₄ -/l)	Less than 1.0	Less than 0.1	•	
Remaining Chlorine(mg Cl/l)	Less than 0.3	Less than 0.3	•	
Floating Carbonic Acid (mg CO ₂ /l)	Less than 4.0	Less than 4.0	•	
Index of Stability	6.8~8.0	-	•	•

NOTE

- The mark “•” in the table means the factor concerned with the tendency of corrosion or deposits of scales.
- The value showed in “{ }” are for reference only according to the former unit.

14.5 Electric wiring and the application

General check

•Make sure that the following conditions related to power supply installation are satisfied: The power capacity of the electrical installation is large enough to support the power demand of the HAIER system.

The power supply voltage is within $\pm 10\%$ of the rated voltage.

The impedance of the power supply line is low enough to avoid any voltage drop of more than 15% of the rated voltage.

•Following the Council Directive 2004/108/EC, relating to electromagnetic compatibility, the table below indicates the Maximum permitted system impedance Z_{max} at the interface point of the user's supply, in accordance with EN61000 3 11.

Model	Power supply	ZMax.(Ω)
AU052FYCRA(HW)	1PH, 220-240V~, 50/60Hz	0.35
AU082FYCRA(HW)		0.35
AU112FYCRA(HW)		0.24
AU162FYCRA(HW)		0.24

⚠WARNING

•Switch off the main power switch of the indoor and outdoor machine for more than 1 minutes before the wiring or regular inspection.

•To prevent the destruction of wires and electrical components by rats or other animals. Serious, it may lead to the occurrence of fire.

•To avoid damage to the wire, avoid contact with refrigerant pipes, steel edges and electrical components. Serious, it may lead to the occurrence of fire.

⚠CAUTION

•Secure the power cord with a wire tie in the machine.

Note:

When the wiring of the outdoor machine is not using the wire, it should be fixed with the rubber ring

⚠CAUTION

•In the case of 3 phase 5 wire type, the power supply of the indoor machine must be connected use L1 line and N line, prohibit the use of L1-L2, L1-L3, Otherwise the electrical part will be damaged.

Inspect

•To ensure that the electrical equipment used on the installation site (main power switch, circuit breaker, wire, conduit and wiring terminals, etc.) have been selected according to current data, to ensure that the device in line with national standards.

•Check the power supply voltage in the range of 10% of the rated voltage and the ground wire is included in the power supply line. Otherwise, electrical parts will be damaged.

•.Check whether the power supply is satisfied. Otherwise, the compressor will not start when the voltage is too low.

•By measuring the insulation resistance between the ground and the electrical device terminals, to ensure that more than 1 MΩ. Otherwise, the system can not be started until the cause of leakage and maintenance.

Connection

•Connect the power cord to the terminal of the indoor unit and the outdoor mechanical and electrical gas box, connect the ground wire to the grounding bolt of the outdoor machine and the indoor mechanical and electrical air box.

•Connect the external and internal communication lines to the 1 and the 2 terminals on the terminal. If the power cord is connected, the printed circuit board will be damaged. And the use of shielded twisted pair wire.

•Do not connect the fastening screws on the front of the cover.

•The power cord must be made of copper wire, and the power supply must be in line with IEC 60245 requirements. If the power cord length exceeds 20m, the need to increase the size.

•The power supply line is fixed with a round connection terminal with an insulating protective sleeve. Not with sheet metal contact and extrusion, in order to avoid the cut line of skin caused by fire.

Communication wiring figure

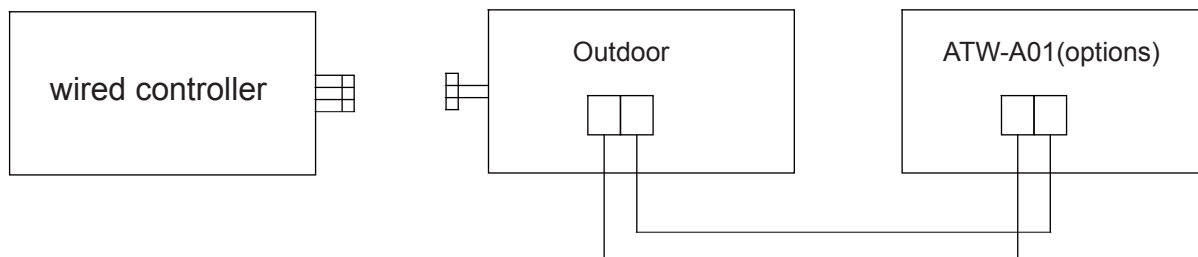

The outdoor and ATW-A01 units are in parallel through 2 non-polar wires.

Power wiring figure

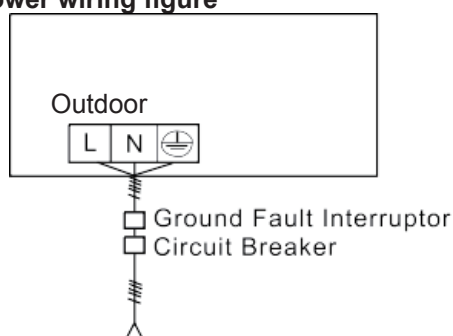

power source: 1PH, 220-240V~, 50/60Hz

ATW-A01 and outdoor use their individual power source

Outdoor power source and power cable

Model \ Item		Power source	Power cable section (mm ²)	Circuit breaker (A)	Rated current of residual circuit breaker (A) Ground fault interruptor (mA) response time (S)	Ground wire	
						Section (mm ²)	Screw
Individual power	AU052FYCRA(HW)	1PH, 220- 240V~, 50/60Hz	6	30	30A 30mA below 0.1S	6	M4
	AU082FYCRA(HW)		6	32	32A 30mA below 0.1S	6	M4
	AU112FYCRA(HW)		6	32	32A 30mA below 0.1S	6	M4
	AU162FYCRA(HW)		8	40	40A 30mA below 0.1S	8	M4

- Power cable must be fixed firmly.
- To avoid electrical shock, make sure to disconnect the power supply 1 minute or more before servicing the electrical parts. Even after 1 minute, always measure the voltage at the terminals of main circuit capacitors or electrical parts and before touching, make sure that those voltages are 50VDC or less.
- To persons in charge of electrical wiring work: Do not operate the unit until the refrigerant piping is complete. (Running it before the piping is ready will break the compressor)
- Each outdoor must be earthed well.
- When power cable exceeds the range, thicken it appropriately.
- The appliance shall be installed in accordance with national wiring regulations.
- All wiring must be performed by an authorized electrician.
- Be sure to install an earth leakage circuit breaker in accordance with applicable legislation. Failure to do so may cause electrical shock.

Communication wire for wired controller

Length of Signal Line (m)	Wiring Dimensions
≤250	0.75mm ² × 3 core shielding line

- The shielding lay of the signal line must be grounded at one end.
- The total length of the signal line shall not be more than 250m.

Outdoor unit electrical wiring diagram

AU052FYCRA(HW) AU052FYCRA(HW)

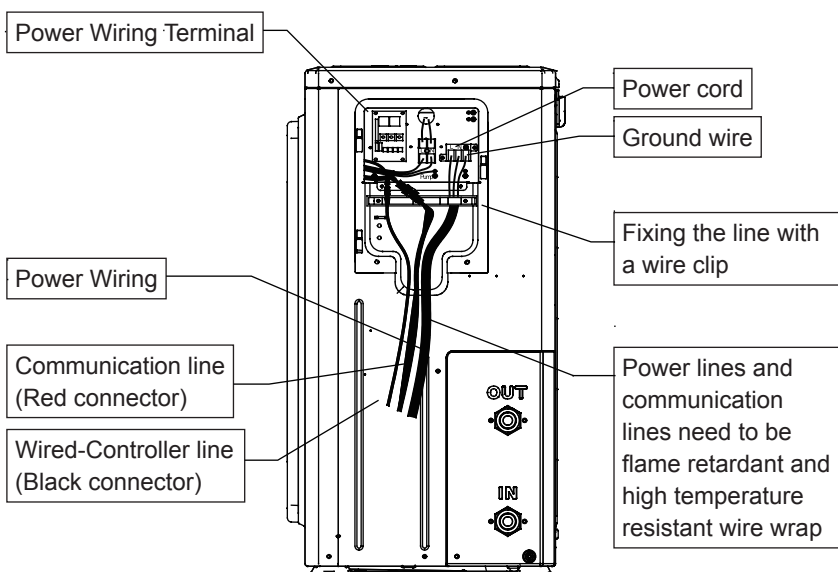
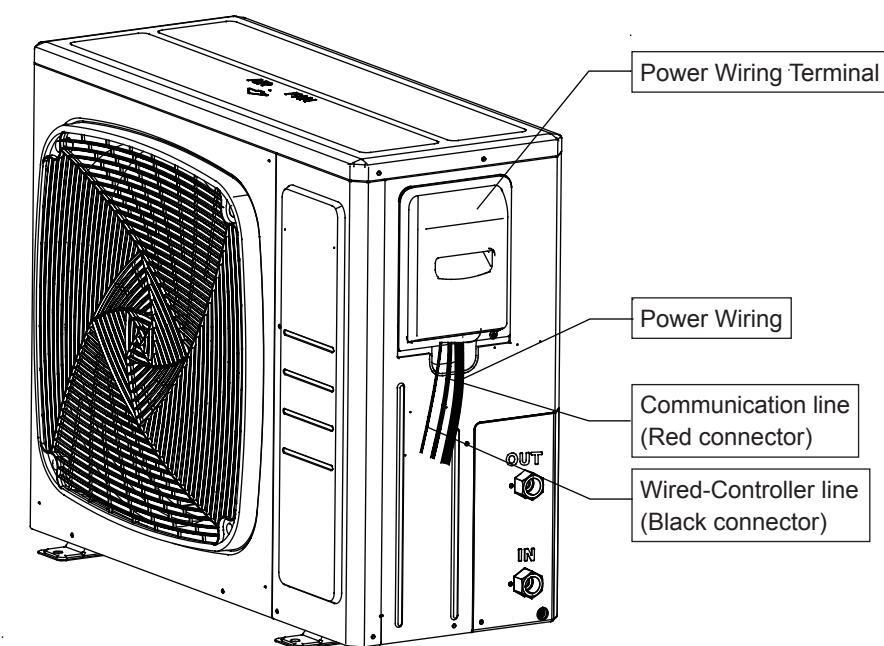

AU082/112/162FYCRA(HW)

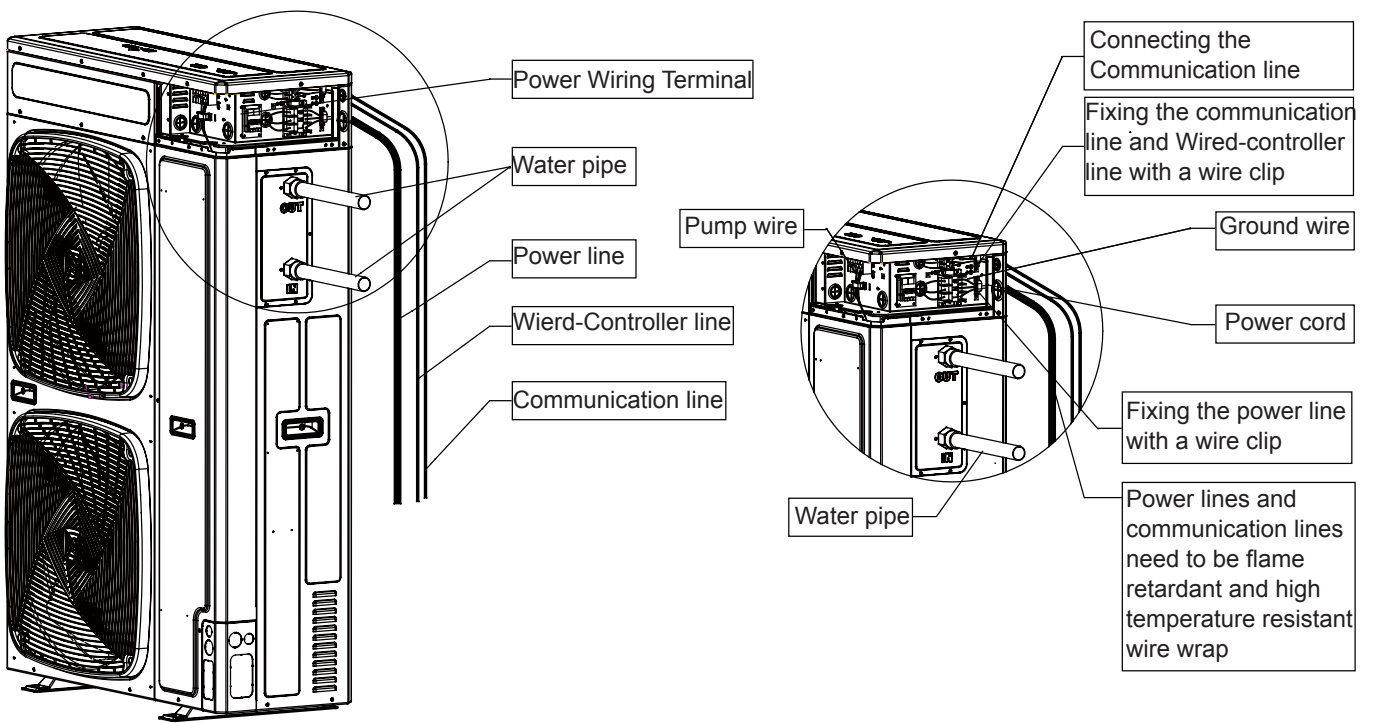
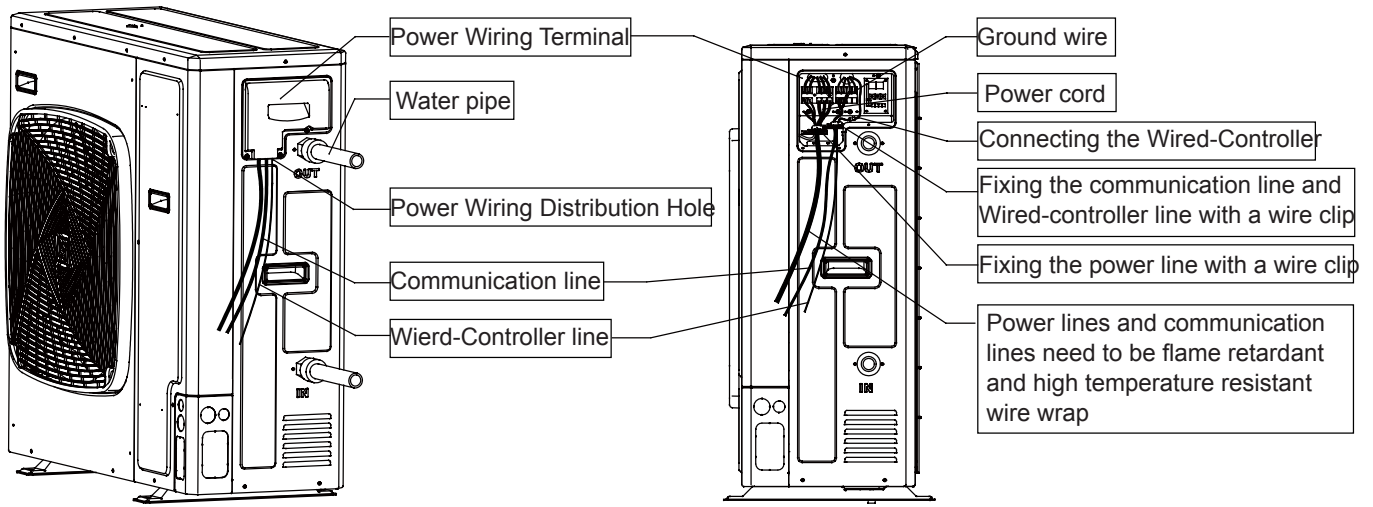

<p>Correct</p>	<p>Error</p>	<p>When using a single terminal without terminal, the terminal can not be directly used without flux. Otherwise, it will cause abnormal heating of terminal crimping part. If a single core wiring is used in the wiring, it can be connected directly in the manner shown in the diagram.</p>
----------------	--------------	--

Auxiliary heater installation instructions

- ① Auxiliary heater source requirements: Auxiliary heater is recommended when the minimum temperature is below -10°C .
Capacity: according to the local actual situation.
Power supply: 230V~,50Hz.
Protection: dry heating protector, over current protector, overheating protector, Electricity leakage protector.
- ② Installation position: as shown in the dotted line box in the installation drawing of water system.
- ③ Wiring instructions: Appropriate AC contactor and power cord should be provided according to the auxiliary heat capacity.

- ④ Control:
When the auxiliary heat starts, the outdoor unit outputs 230V control signal to the relay.
Only when auxiliary heat is installed, it is allowed to be forcibly controlled by the wire controller; Otherwise, the wire controller cannot be used to control the auxiliary heat.

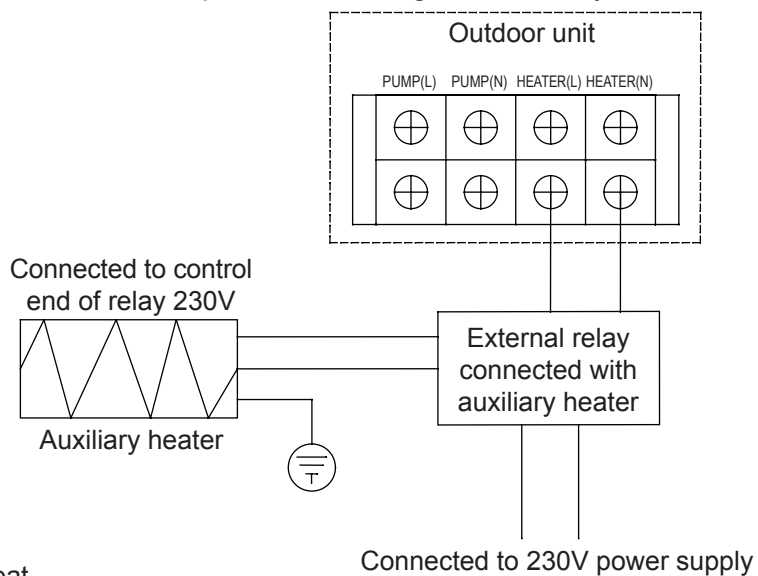

15. PCB Photo

PCB code: 0151800423

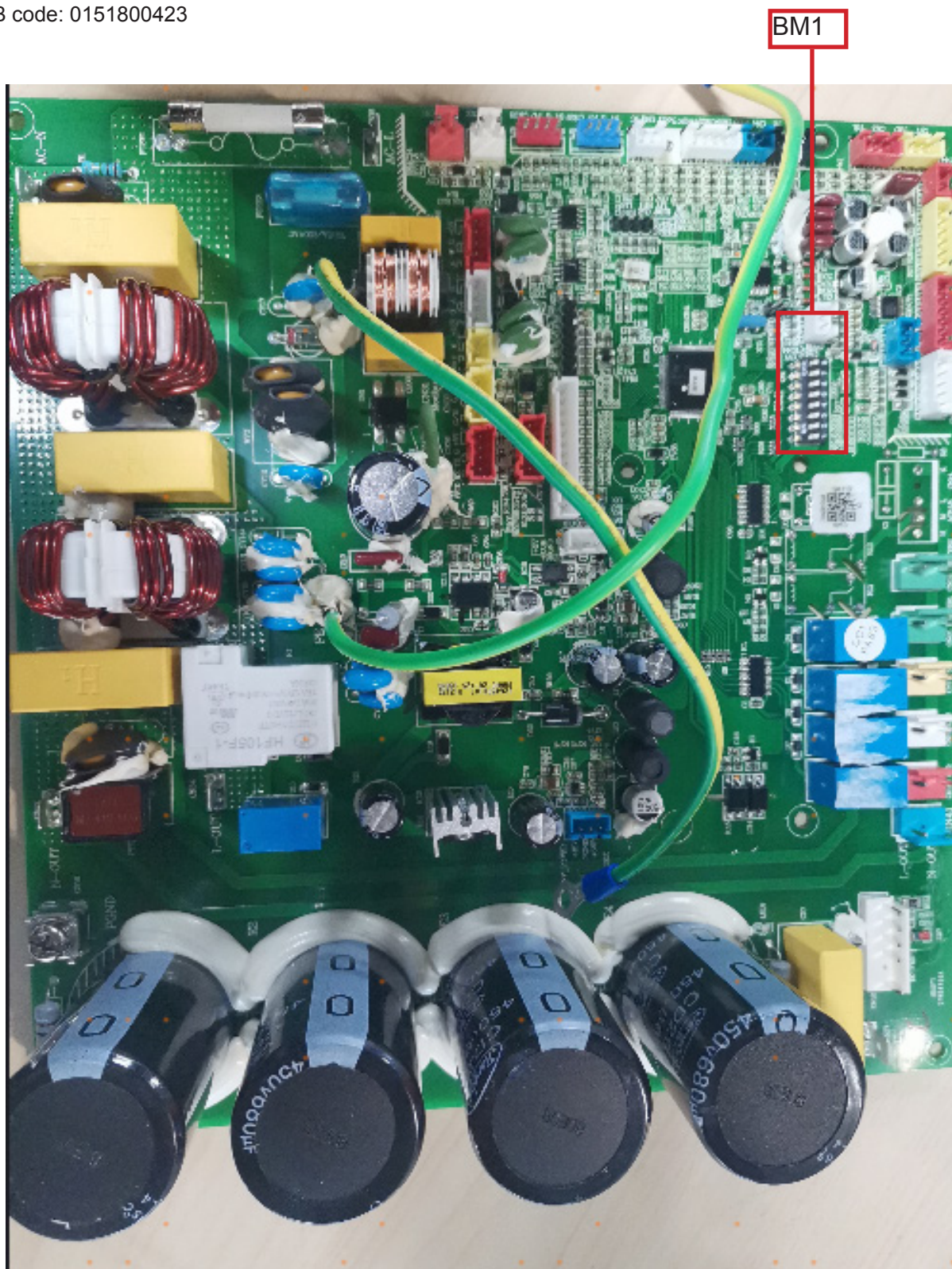

0151800420A



16. Dip Switch Setting

BM1 introduction

BM1_1	Control type selection	OFF	Wired controller control (default)			
		ON	ATW-A01 control			
BM1_2 BM1_3 BM1_4 BM1_5	Outdoor unit Model selection	[2]	[3]	[4]	[5]	Outdoor unit Model selection
		OFF	OFF	OFF	ON	AU052FYCRA(HW)
		OFF	OFF	ON	OFF	AU082FYCRA(HW)
		OFF	ON	OFF	OFF	AU112FYCRA(HW)
		OFF	ON	OFF	ON	AU162FYCRA(HW)
BM1_6	Power selection	OFF	Single phase (default)			
		ON	Three phases			
BM1_7	Reserved	OFF	Reserved (default)			
		ON	Reserved			
BM1_8	ATW-A01 selection	OFF	No ATW-A01 (default)			
		ON	Connect with ATW-A01			

BM2 introduction

BM2_1	Heat exchange unit type	OFF	Air condition heat exchange unit(default)			
		ON	Hot water heat exchange unit			
BM2_2	Control mode selection	OFF	When in 2-way valve linkage mode, need connect the ON/OFF signal of fan coil or floor heating to CN47 on the ODU's main PCB, only CN47 get on signal and start the ODU on the wired controller, then the ODU can start up.			
		ON				
BM2_3	HU electrical heating control mode	OFF	Reserve			
		ON				
BM2_4	Water flow switch fault shielding selection	OFF	Reserve			
		ON				
BM2_5	PC and MODBUS selection	OFF	Reserve			
		ON				
BM2_6 BM2_7	Running mode selection	[6]	[7]	Running mode selection		
		OFF	OFF	Normal mode (default)		
		OFF	ON	Powerful mode-----compressor low speed running		
		ON	OFF	Silent mode---compressor low speed running		
BM2_8	Hot water mode selection	OFF	No hot water (default)			
		ON	Hot water mode			

bridge instruction

CJ1:

Short it before power ON-- PCB check its function (used for factory production. Short it after power ON-- time short function, 60 seconds become to 1 second. CJ2: Reserved

Default switch setting

AU052FYCRA(HW)

	[1]	[2]	[3]	[4]	[5]	[6]	[7]	[8]
BM1	OFF	OFF	OFF	OFF	ON	OFF	ON	OFF
BM2	OFF	ON	OFF	OFF	OFF	OFF	OFF	OFF

AU082FYCRA(HW)

	[1]	[2]	[3]	[4]	[5]	[6]	[7]	[8]
BM1	OFF	OFF	OFF	ON	OFF	OFF	ON	OFF
BM2	OFF	ON	OFF	OFF	OFF	OFF	OFF	OFF

AU112FYCRA(HW)

	[1]	[2]	[3]	[4]	[5]	[6]	[7]	[8]
BM1	OFF	OFF	ON	OFF	OFF	OFF	ON	OFF
BM2	OFF	ON	OFF	OFF	OFF	OFF	OFF	OFF

AU162FYCRA(HW)

	[1]	[2]	[3]	[4]	[5]	[6]	[7]	[8]
BM1	OFF	OFF	ON	OFF	ON	OFF	ON	OFF
BM2	OFF	ON	OFF	OFF	OFF	OFF	OFF	OFF

17. Digital Tube Display

Part code: 0151800405A

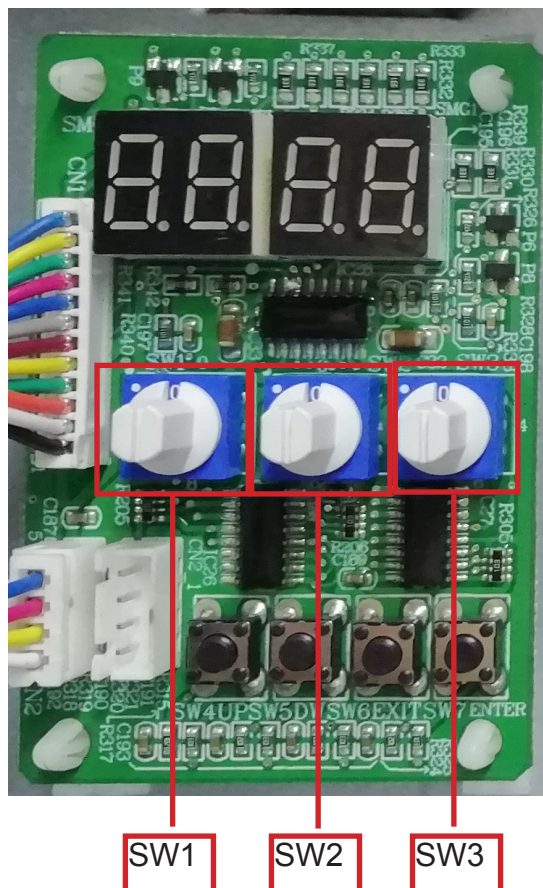

Main function instruction:

By setting the rotary switch, the digital tube will display the unit parameters, the data is inform of decimal integer. During the process of installation, adjustment and maintenance, the whole system's operating parameters can be tested conveniently which can help to check and solve problems quickly and correctly.

SW1	SW2	SW3	Segment digital tube display content LD2~4
0	0	0	Err code: "000" means no err happen
0	2	0	Operating mode: Stop:OFF; Cooling mode: CCC; Heating mode: HHH;
0	3	0	Outdoor fan 1 motor speed(rpm) "345" means 345rpm.
0	4	0	Outdoor fan 2 motor speed(rpm) <ul style="list-style-type: none"> •Motor speed can be set through pressing "ENTER(SW7)" with 3 seconds, in which "111" will be displayed and the speed and speed class will be showed in turn. Speed class can be increased a grade through pressing "UP"once and can be decreased a grade through pressing "DOWN"once; •"000" will be showed through pressing "Exit(SW6)" with 3 seconds and setting mode will be exit.

SW1	SW2	SW3	Segment digital tube display content LD2~4
0	5	0	Actual frequency of compressor(Hz): 90 means 90Hz •Frequency of compressor can be set through pressing “ENTER(SW7)” with 3 seconds, in which “111” will be displayed and the frequency showed. Frequency can be increased one Hz through pressing “UP” once and can be decreased one Hz through pressing “DOWN” once; •“000”will be showed through pressing “Exit(SW6)” with 3 seconds and setting mode will be exit.
0	7	0	Electronic expansion valve step (LEVa1): 90 means 90pls
0	9	0	Electronic expansion valve step (LEVa2): 90 means 90pls
0	B	0	Valve output status: LD2: 4WV: (0-off, 1-on); LD3: SV1: (0-off, 1-on); LD4: SV2: (0-off, 1-on)
0	C	0	High pressure switch and Low pressure switch status: LD2: High pressure switch: HPS: (0-off, 1-on) LD3: Low pressure switch: LPS: (0-off, 1-on) LD4: reserved: “-”
0	D	0	Reserved
0	E	0	Compressor electrical heater output: LD2: CH1: (0-off, 1-on);LD3: BH:(0-off, 1-on); LD4: reserved: “-”
0	F	0	Software version:“1.0”means Ver1.0.
0	0	1	Pd: Pressure of discharge:unit: kg, a decimal fraction
0	2	1	Ps: Pressure of suction: unit: kg, a decimal fraction
0	3	1	Td: discharge temperature : (unit:°C)
0	5	1	Tdef: defrost temperature: (unit:°C)
0	7	1	Toil: oil temperature: (unit:°C)
0	9	1	Tc: condensing temperature (unit:°C)
0	E	1	Ts: suction temperature (unit:°C)
0	1	F	Tao Tao: ambient temperature (unit:°C)
0	2	F	Pd_temp:condensing temperature (unit:°C)
0	4	F	Ps_temp: evaporate temperature (unit:°C)
0	5	F	Tliqsc (unit:°C)
0	6	F	Tsco (unit:°C)
0	8	F	Operating time of compressor: Unit: hour
0	A	F	Operating current of compressor: unit: A, a decimal fraction
0	B	F	Unit current: CT: unit: A, a decimal fraction
0	C	F	Direct current voltage of Invertor comperssor: unit: V
0	E	F	Invertor module temperature of compressor: (unit:°C)
0	0	7	Outlet water temperature Two (°C)
0	0	8	Ref Rerigerate gas pipe temperature Tho (°C)
0	0	9	Refrigerate liquid pipe temperature Thi (°C)
0	0	B	Inlet water temperature Twi (°C)
0	0	C	Hydraulic features:No.1: water flow switch (0-cut off, 1-connected) No.2: Pump status (0-off, 1-on);No.3:Electrical heating (0-off, 1-on) (i.e. “110” means water flow switch is closed, pump is on and Electrical heating is off)
0	0	D	Hydraulic features:No.1: supply water flow switch (0-cut off, 1-connected) No.2: unit on/off signal(0-off, 1-on);No.3: Floor heating valve output status (0-off, 1-on) (i.e. “001” means supply water flow switch is connected,Indoor unit on/off signal is off and Floor heating valve output status is on.)

18. Startup & Running & Maintenance

a) Preparing for first start up

Restarting after shutting down for long periods

The Heat pump must be started up for the first time by the Technical Service. Before starting up the Heat pumps, make sure that:

- All safety conditions have been respected.
- The Heat pump system is adequately fixed to the surface it rests on.
- Functional distances have been respected.
- Hydraulic connections have been carried out as indicated in the manual.
- The water circuit is filled and vented. When draining after heat pump operation, take care as the water may be hot.
- The water circuit valves are open.
- Electrical connections have been carried out correctly.
- Voltage is within a tolerance of 10% of the rated voltage for the unit.
- The unit is correctly earthed.
- All electrical and hydraulic connections are tight and have been completed correctly.

b) Operating characteristics

Set point in cooling mode

(factory set) = 12°C, Hysteresis = 5°C.

The compressor starts with water temperatures above 12°C.

The compressor shuts down with water temperatures of less than 7°C.

Set point in heating mode

(factory set) = 45°C, Hysteresis = 5°C.

The compressor starts with water temperatures below 45°C.

The compressor shuts down with water temperatures above 50°C.

In the event of a temporary power failure, when power returns, the mode set previously will be retained in the memory.

Compressor start up delay

Two functions prevent the compressor from starting up too frequently

- Minimum time since last start-up 300 seconds.

Fan speed control

For correct operation of the unit with different outside temperatures, the microprocessor controls the fan speed based on the pressure reading from the pressure probe, thus enabling heat exchange to be increased and/or decreased, maintaining the condensing or evaporation temperature practically constant.

The fan functions independently of the compressor.

Frost prevention alarm

To prevent the water freezing and damaging the heat exchanger, the microprocessor shuts down the compressor if the temperature measured by the heat exchanger outlet temperature sensor is less than 3°C. The frost prevention temperature set point can be modified by an authorized service center only and only after verifying that the water circuit contains antifreeze. Tripping of this alarm shuts down the compressor but not the pump, which remains active. To reset normal functions, the outlet water temperature must rise to more than +8°C. Reset is manual.

Water flow alarm

The microprocessor provides for management of a water flow alarm controlled by a pressure difference switch fitted as standard on the appliance to be installed on the water delivery piping.

This safety device may trip after the first 60 seconds of pump operation when the water flow is up to speed. Tripping of this alarm shuts down the compressor but not the pump, which remains active. To reset normal functions, the alarm contact must be deactivated for at least 15 seconds.

When electrical current exceeds to setting value and condenser temperature over than 62°C, system will shut down, but not returns to normal operation until the condenser temperature decreased less than 52°C.

c)Routine maintenance

Never perform any cleaning operations before having disconnected the unit from the mains power supply. If the supply cord is damaged, it must be replaced by the manufacturer or its service agent or a similarly qualified manufacturer or its service agent or a similarly qualified.

Regular maintenance is fundamental to maintain the efficiency of the unit both in terms of operation and energy consumption. The Technical Assistance Service maintenance plan must be observed, with an annual service which includes the following operations and checks:

- Filling of the water circuit.
- Presence of air bubbles in the water circuit.
- Efficiency of safety devices.
- Power supply voltage.
- Power input.
- Tightness of electrical and hydraulic connections.
- Condition of the compressor contactor.
- Efficiency of the plate heat exchanger heater.
- Checking of operating pressure, superheating and sub cooling.
- Efficiency of compressor heater.
- Cleaning of finned coil (*).
- Cleaning of fan grills.
- Cleaning of condensate drain pan (if installed).

(*) For "Heat pump" appliances, the checks are to be performed quarterly.

For units installed near the sea, the intervals between maintenance should be halved.

d)Extraordinary maintenance

Never perform any cleaning operations before having disconnected the unit from the mains power supply.

Chemical washing

You are recommended to chemically wash the plate heat exchanger after every 3 years of operation.

Refrigerant gas content

The Heat pumps are filled with R32 refrigerant gas and tested in the factory. In normal conditions, there should be no need for the Technical Assistance Service to intervene to check the refrigerant gas. However, over time, small leaks may develop at the joints leading to loss of refrigerant and draining of the circuit, causing the unit to function poorly. In this case, the leaks of refrigerant must be identified and repaired and the refrigerant circuit refilled.

Proceed as follows:

-Empty and dry the entire refrigerant circuit using a vacuum pump connected to the low and high pressure tap until the vacuum meter reads about 10Pa. Wait a couple of minutes and check that this value does not rise to more than 200Pa.



-Connect the refrigerant gas cylinder or a filling cylinder to the low pressure line pressure gauge connection.

-Fill with the quantity of refrigerant gas indicated on the rating plate of the unit.

-Always check the superheating and sub cooling values. In the nominal operating conditions for the appliance, these should be between 5 and 10°C and between 4 and 8°C respectively.

-After a couple of hours of operation, check that the liquid indicator indicates circuit dry (dry-green).

Important

In the event of partial leaks, the circuit must be completely emptied before being refilled

The R410a refrigerant must only be filled in the liquid state. Operating conditions other than nominal conditions may produce considerably different values.

Seal testing or identification of leaks must only be carried out using R410a refrigerant gas, checking with a suitable leak detector.

Prohibition

1. The refrigerant circuit must not be filled with a refrigerant other than that indicated of specification.
2. The use of a different refrigerant may cause serious damage to the compressor.
3. Oxygen, acetylene or other inflammable or poisonous gases must never be used in the refrigerant circuit as they may cause explosion or poisoning.
4. Oils other than those indicated on manual before must not be used. The use of different oils may cause serious damage to the compressor.

d) Shutting down for long periods

If it is previewed not to use the machine for long periods After deactivating the Heat pump:

-Make sure the model is in the power off model " ", or alternatively disconnect the unit from the power supply.

-Make sure the remote control switch is closed (if present) .

-Close the water valves.

Important

If there is a possibility that the outside temperature may drop below zero, there is the risk of freezing.

The water circuit **MUST BE EMPTIED AND SHUT OFF POWER** (when draining after heat pump operation take care as the water may be hot) or antifreeze must be added in the proportion recommended by the manufacturer.

19. Error Code

Error code	Error code definitionerror	notes
1	In water temp.sensor(Twi)failure	restorable
2	Out water temp.sensor(Two)failure	
3	In refrigerant temp.sensor(Thi)failure	
4	Out refrigerant temp.sensor(Tho) failure	
7	Communication fault with wired controller	
8	Flow Switch abnormal	ResumableIf it occurs 3 times in an hour, lock the failure
10	Flow rate is too low	
13	System leak water	Un-resumable
15	Antifreeze failure	Resumable If it occurs 3 times in an hour, lock the failure
16	The inlet or outlet water temperature of heat exchange unit HU is too high	Resumable
17	DC water pump failure	Resumable
20	Defrosting temp.sensor(Te)failure	
21	Ambient temp.sensor(Ta)failure	
22	Suction temp.sensor(Ts)failure	
23	Discharging temp.sensor(Td)failure	
28	High pressure sensor failure	
29	Low pressure sensor failure	
30	High pressure switch HPS failure	Restorable, 3 times fault an hour lock
34	Discharging temp. too high protection(Td)	
35	4-way valve reversing failure	
38	High pressure too low protection(Pd)	
39	Low pressure too low(Ps)/compres-sion ratio too high protection	
40	High pressure too high protection(Pd)	
43	Discharging temp. too high protection(Td)	
46	Discharging communication fault with IGBT Power Moudule	restorable
64	CT over current	Once confirmed, un-resumable
68	Communication failure with IO board	Resumable
69	Tank Temperature Failure of Hot Water IO board	Resumable
70	Other faults of hot water IO board	Resumable
71	DC FAN failure	Restorable, 3 times fault an hour lock
75	High-low differential pressure too small/no differential pressure	
81	The temperature of Module is too high	Once confirmed, un-resumable
82	Compressor current protection	
83	Outdoor unit model BM setting error	
110	Module hardware excess current	
111	Compressor out of step	
117	Software excess current	

When the screen of wire controller display hereinafter code,the unit is standby.Please check the parameters according to standby reason.

Standby code	Standby reason	Notes
555.1	Outer circumstance temp.Ta>27°C heating standby	Restorable
555.3	Outer circumstance temp.Ta>54°C or Ta<-10°C, refrigeration standby	
555.4	Oil temp. fail to meet the condition of system start	
555.5	Outdoor unit mode don't match with indoor unit mode ,outdoor unit setting single cold single heat mode conflicted with indoor unit mode cause to standby	

20. Troubleshooting

[1,2,3,4 ,20-24,69] Temperature sensor failure

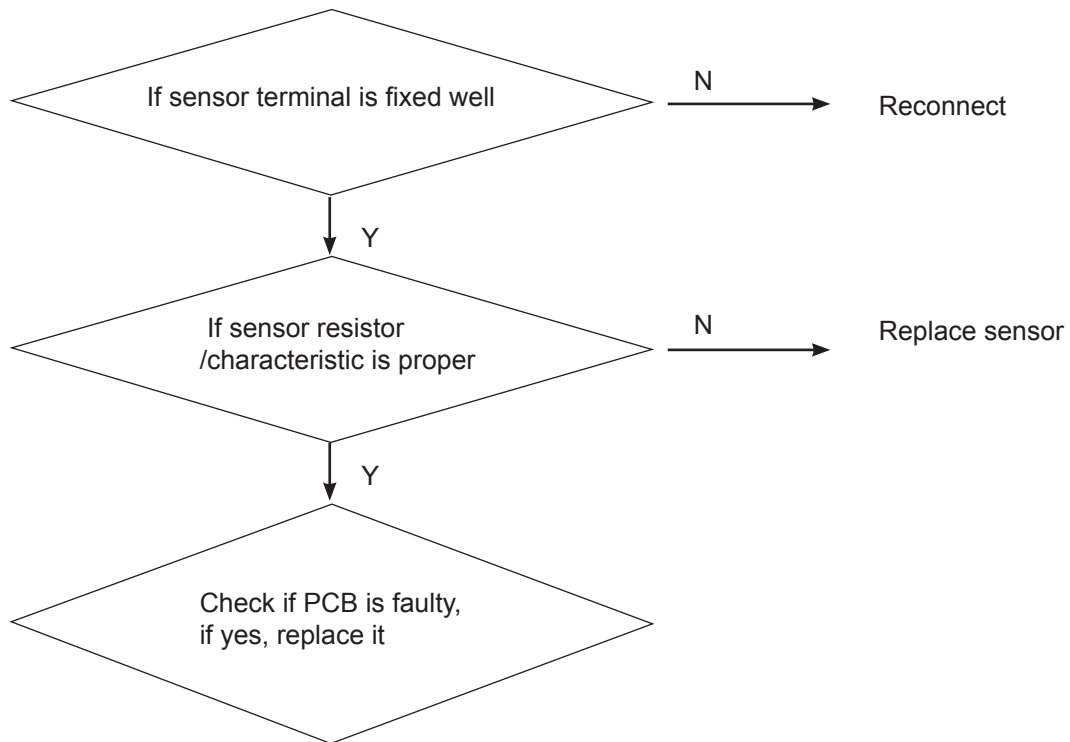

08,10: System water flow protection

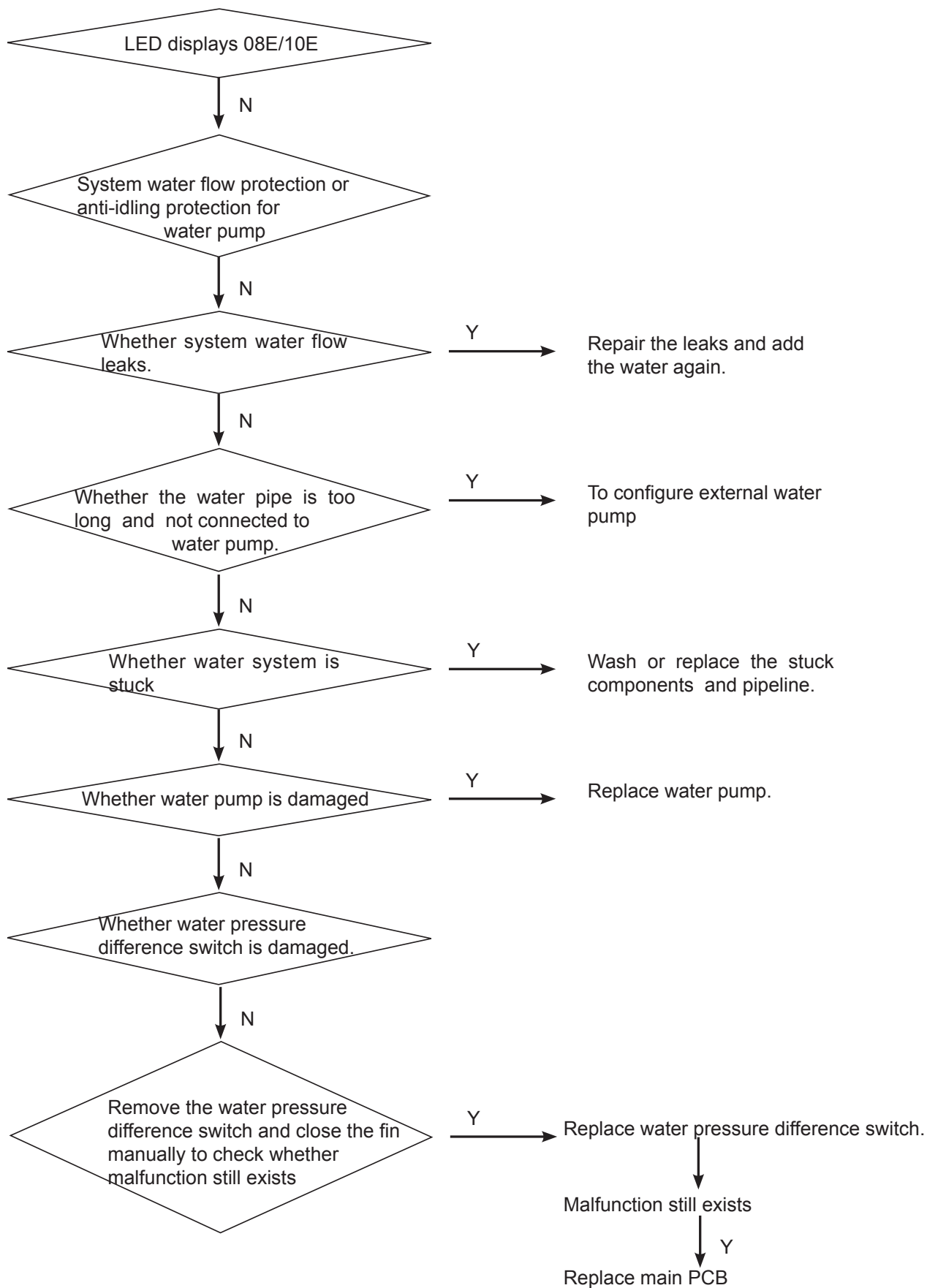

[28, 29] High/low pressure sensor failure

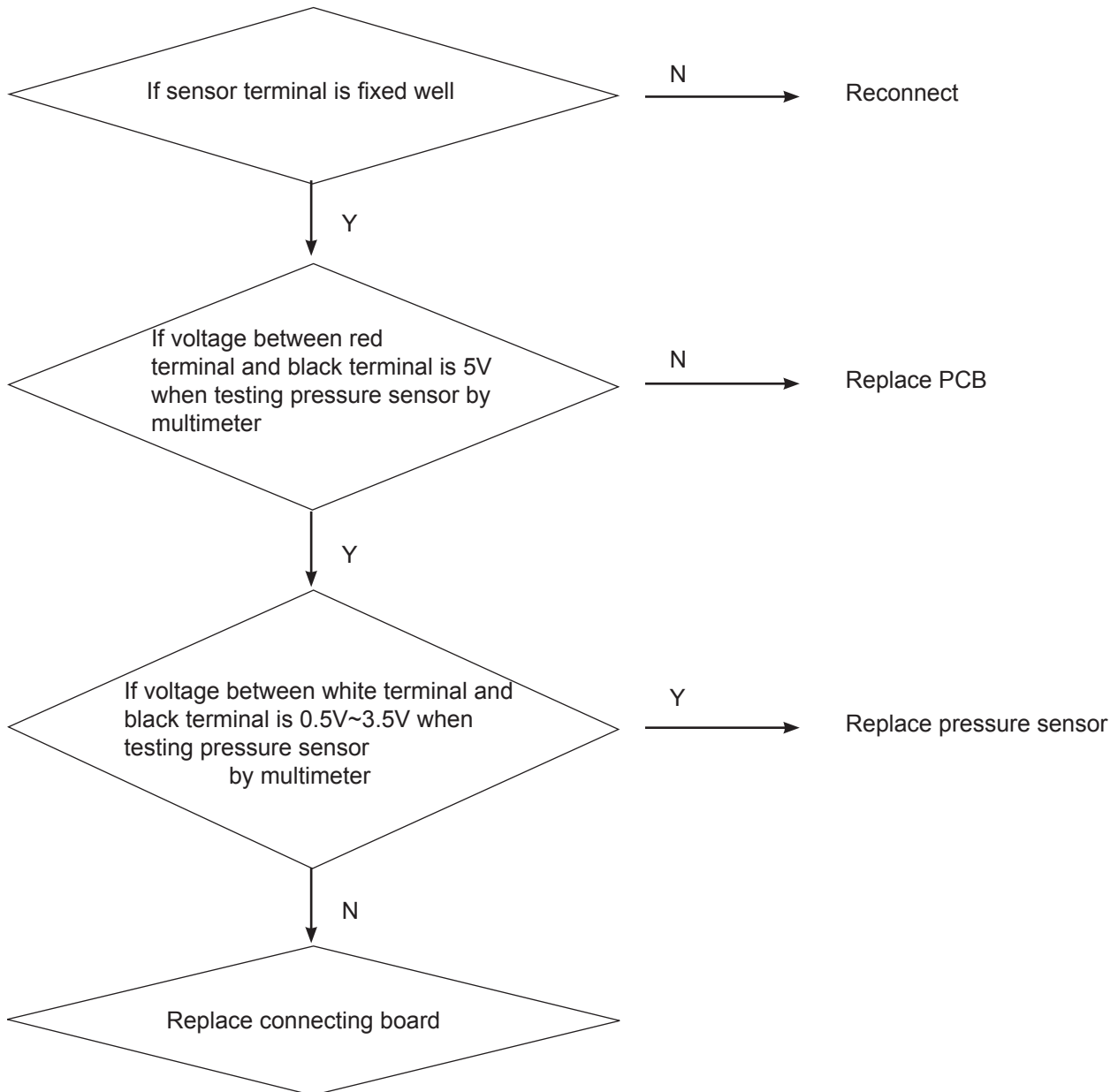

[30] High pressure switch failure

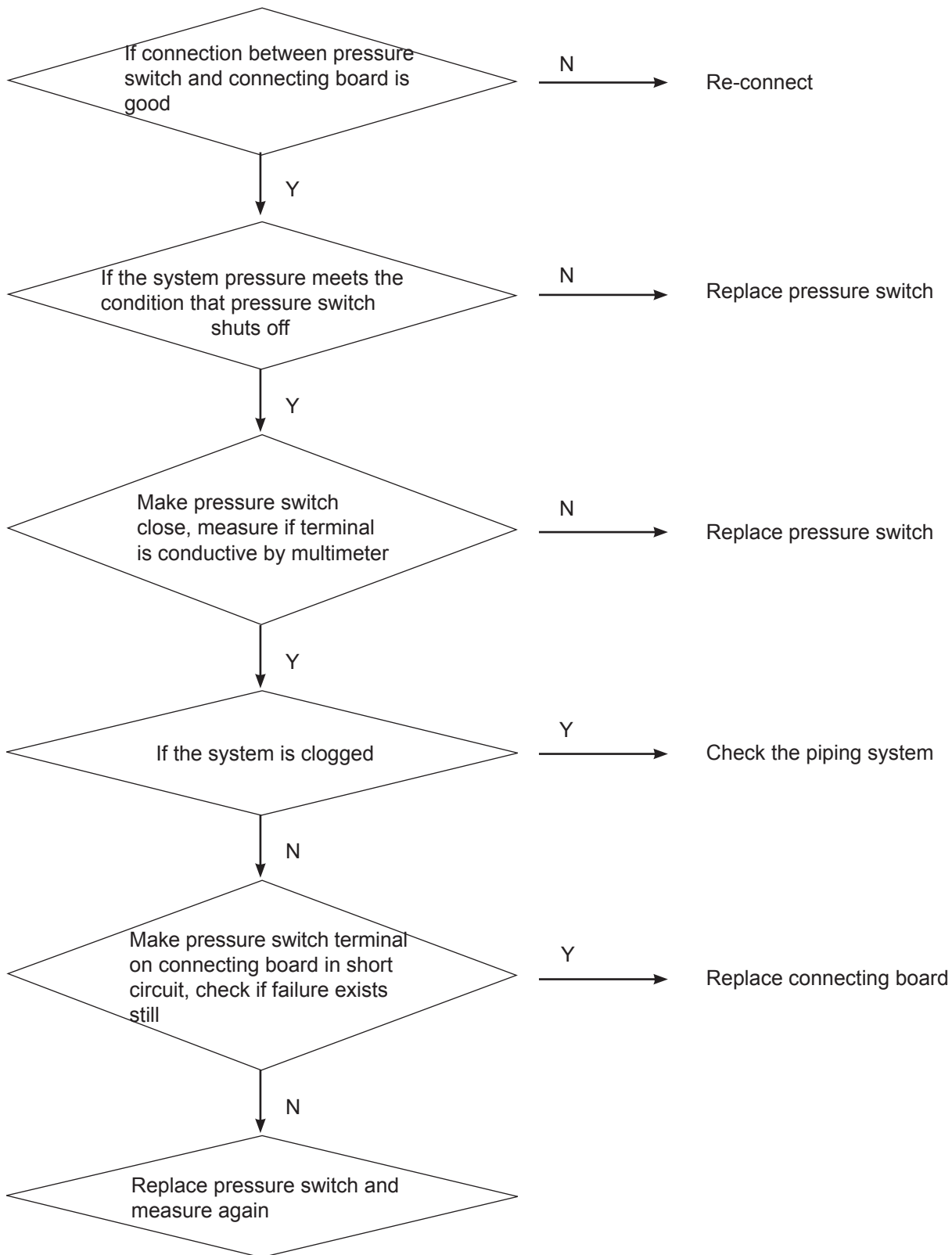

[33] Outdoor EEPROM failure

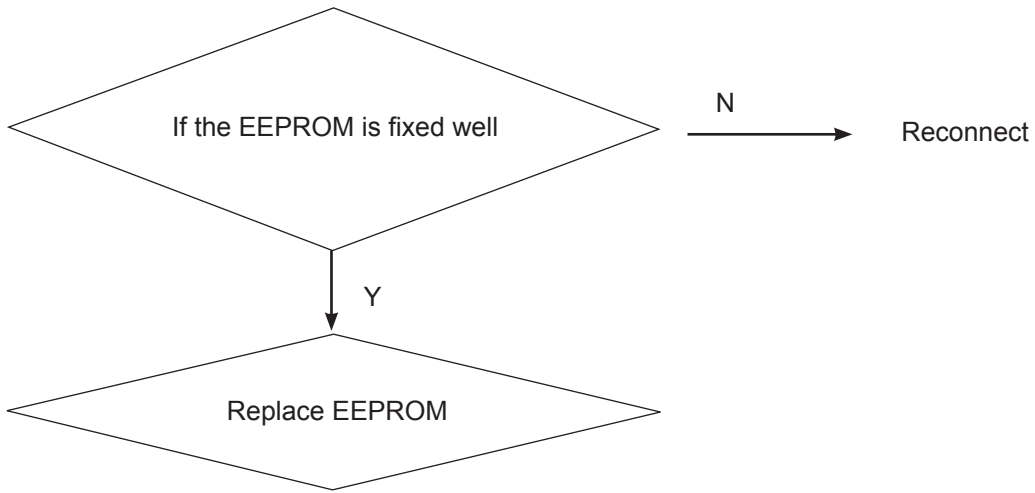

[34] Protection of discharging temp. too high

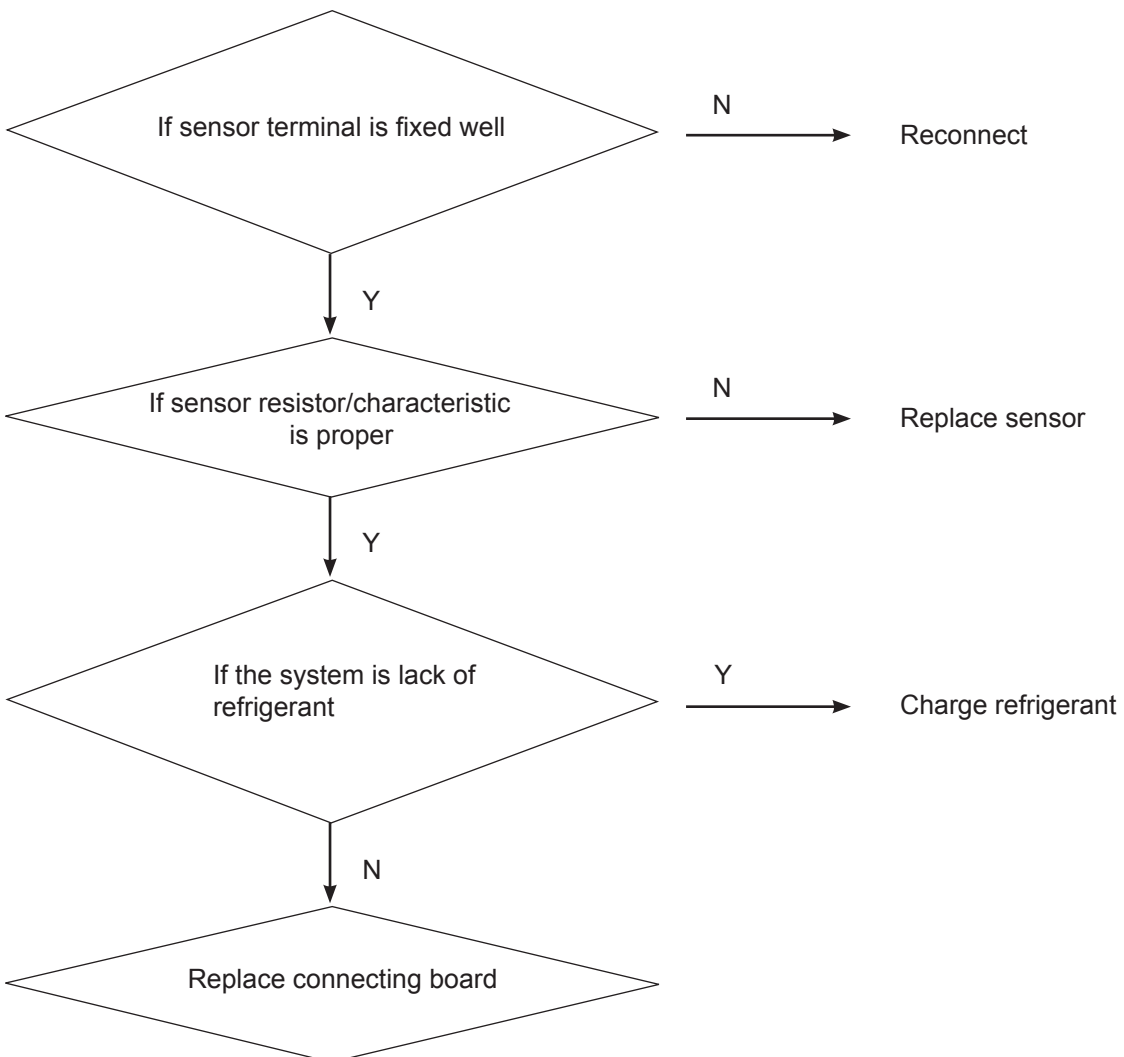

[35] 4-way valve reversing failure, or Temperature sensor Two, Twi, Thi, Tho of Hydraulic module is wrong installed

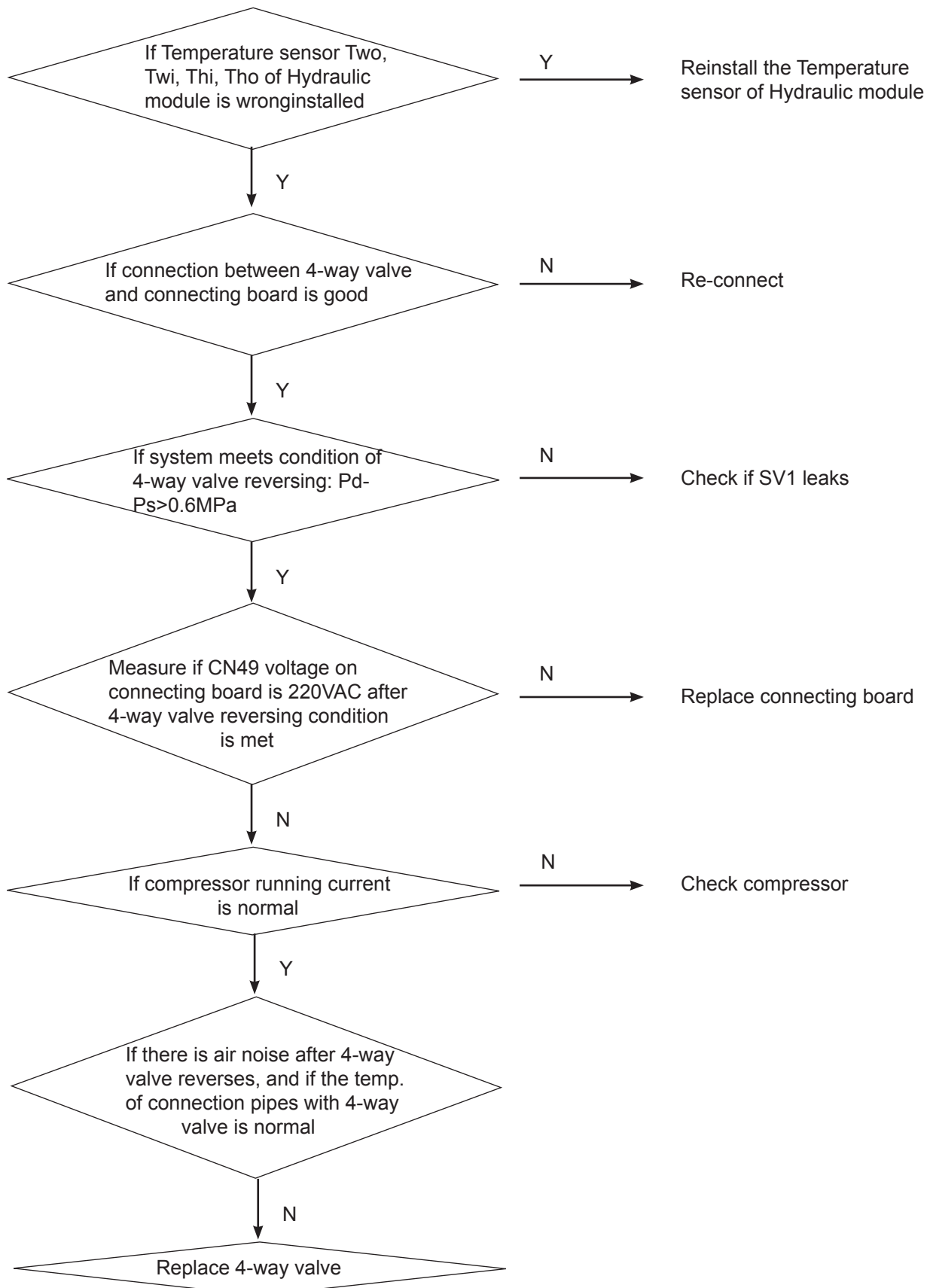

[39-0, 39-1] Low pressure too low and compression ratio too high

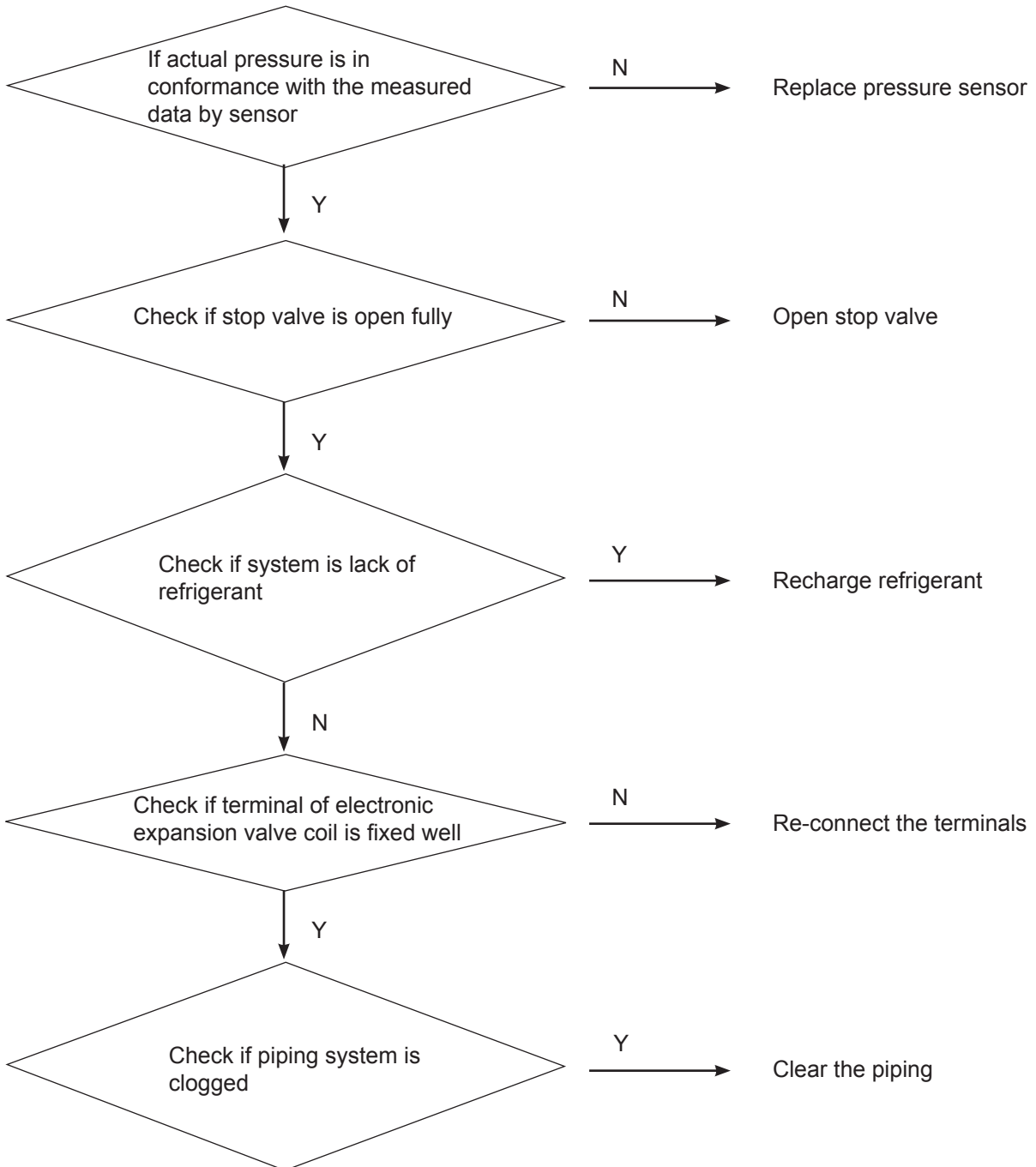

[39-2] Compression ratio too low

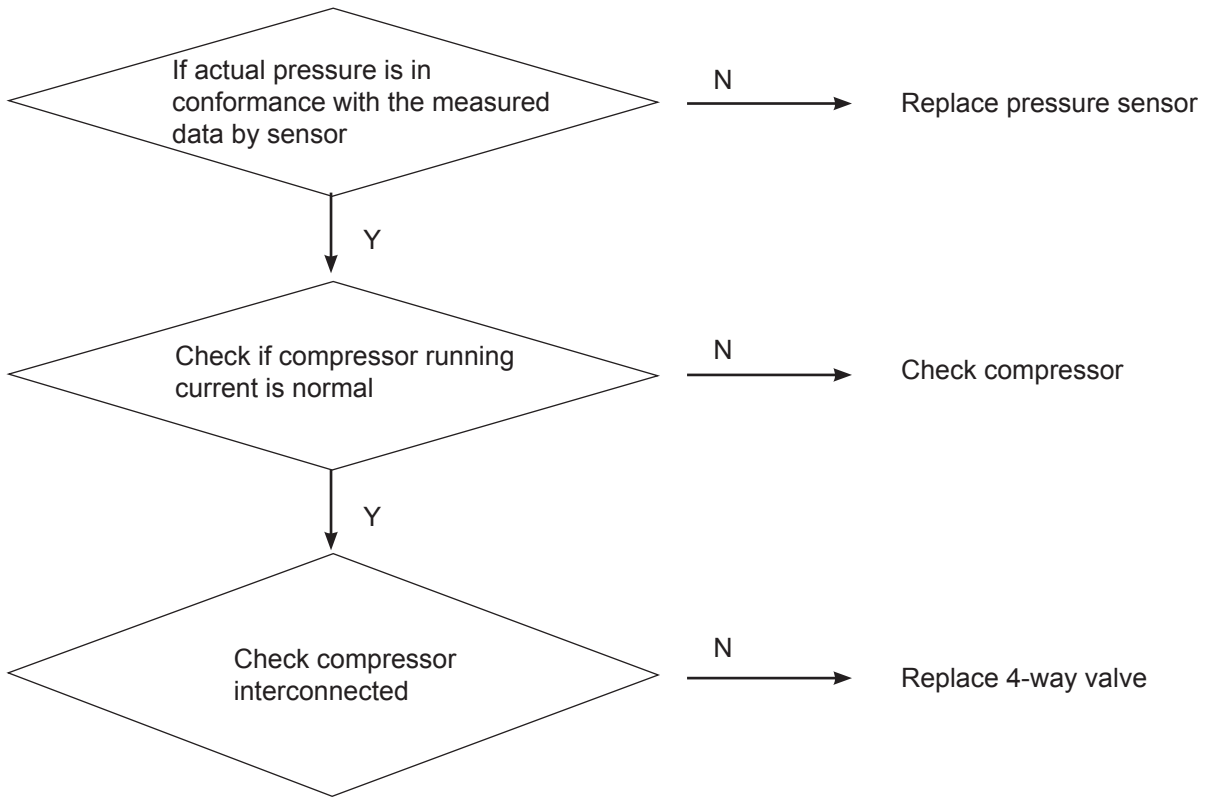

[40] High pressure too high failure

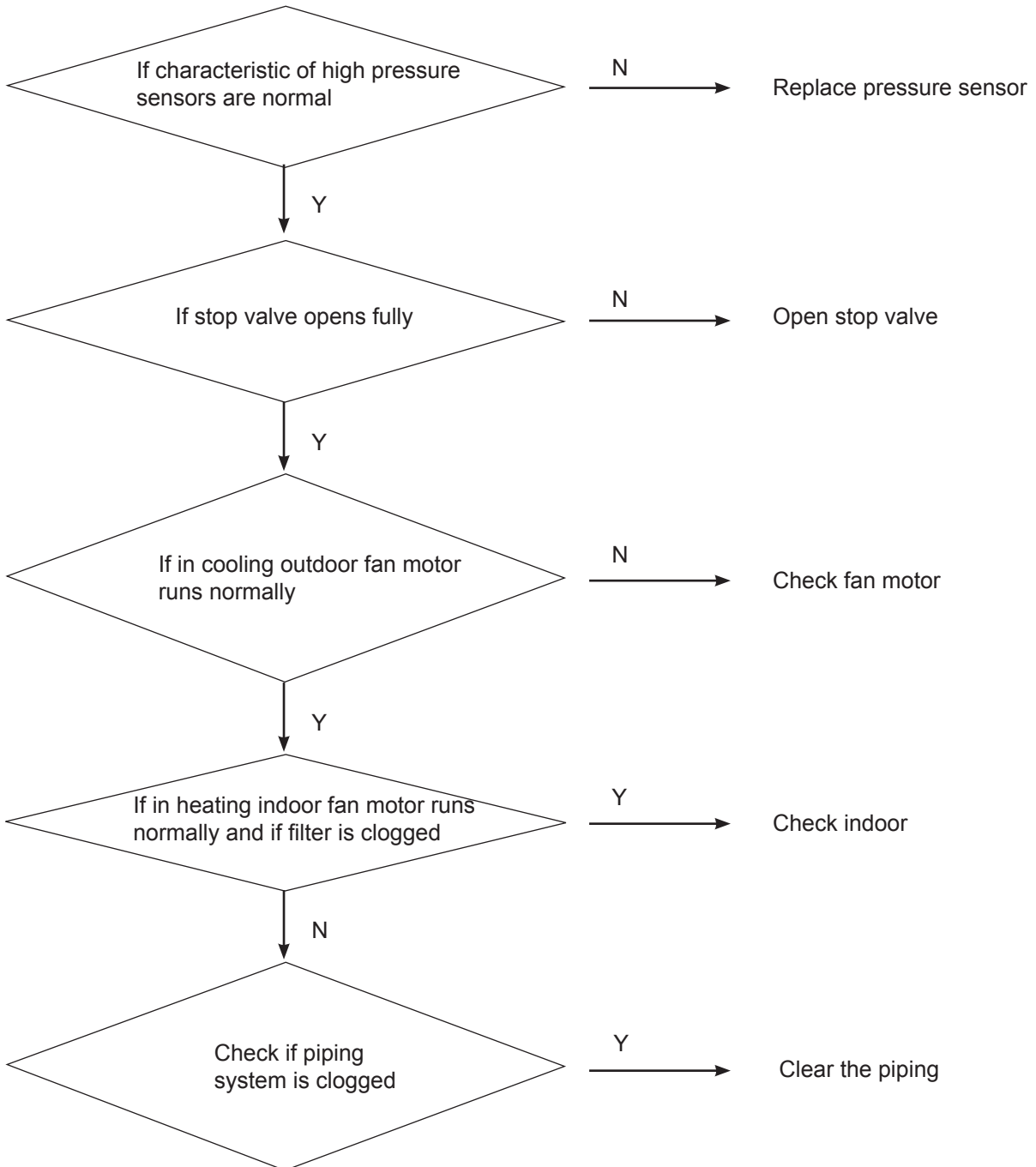

[43] Discharging temp. sensor Td too low protection

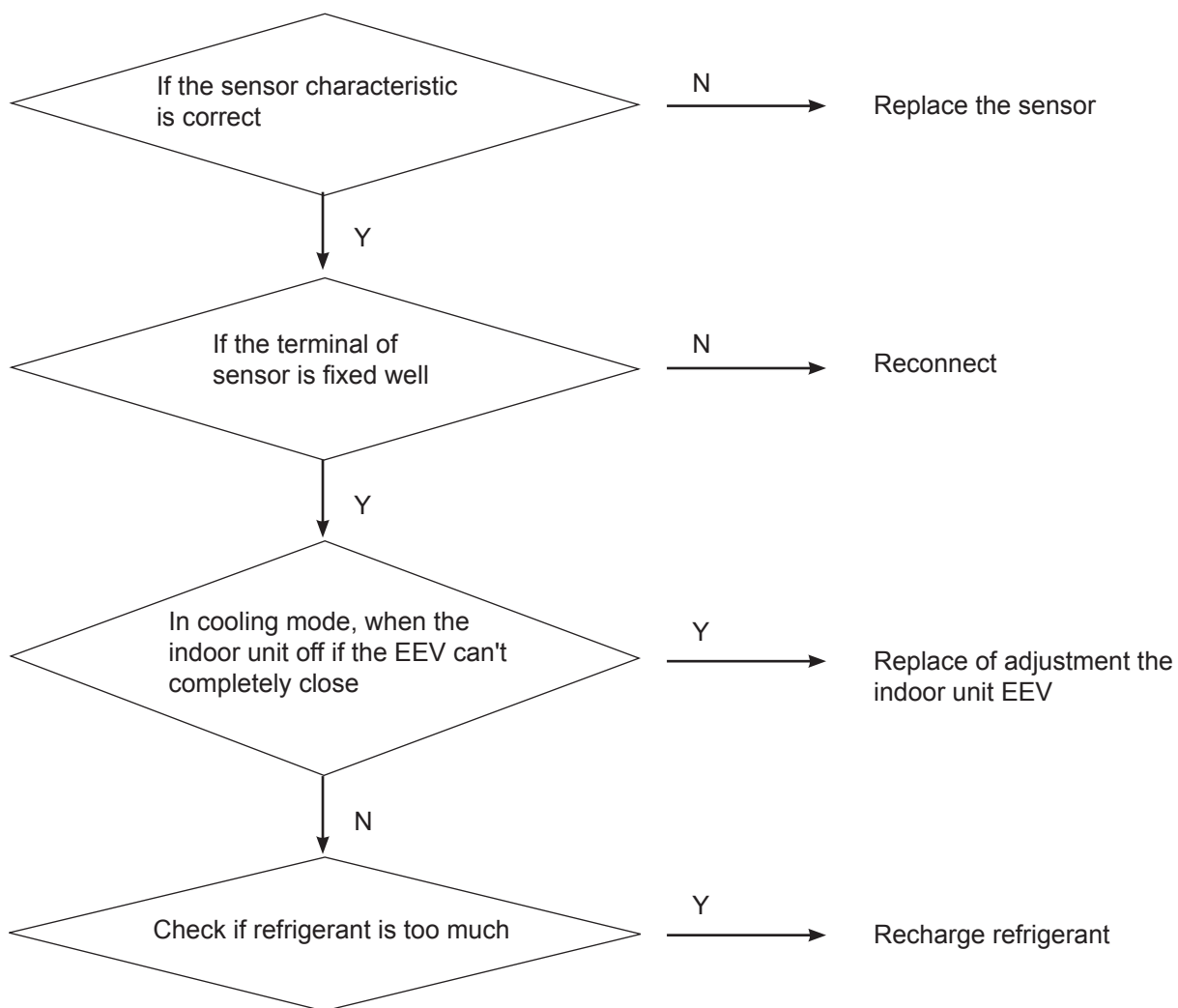

[46] Communication with inverter module failure

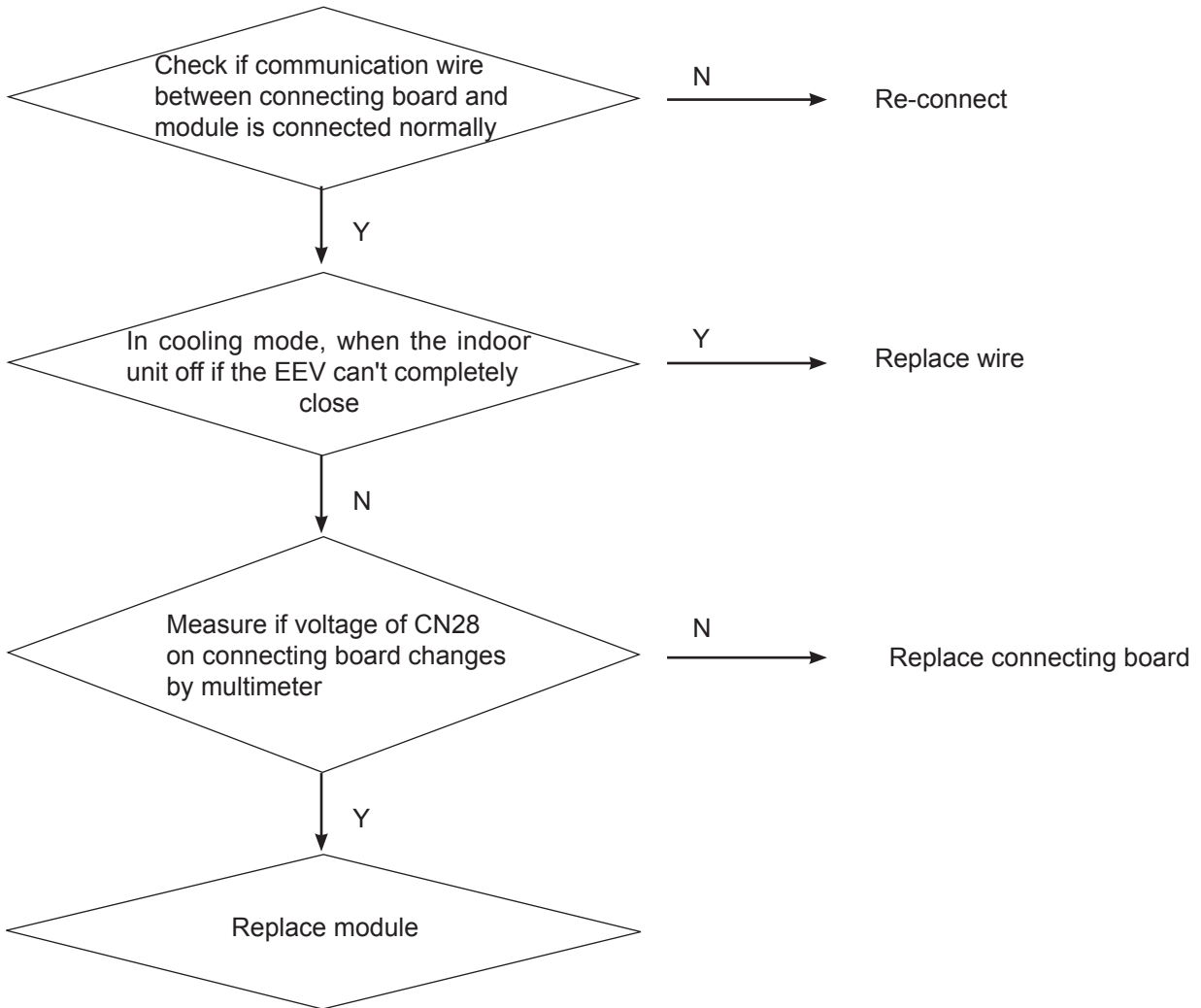

[53] CT Current too low or current sensor failure

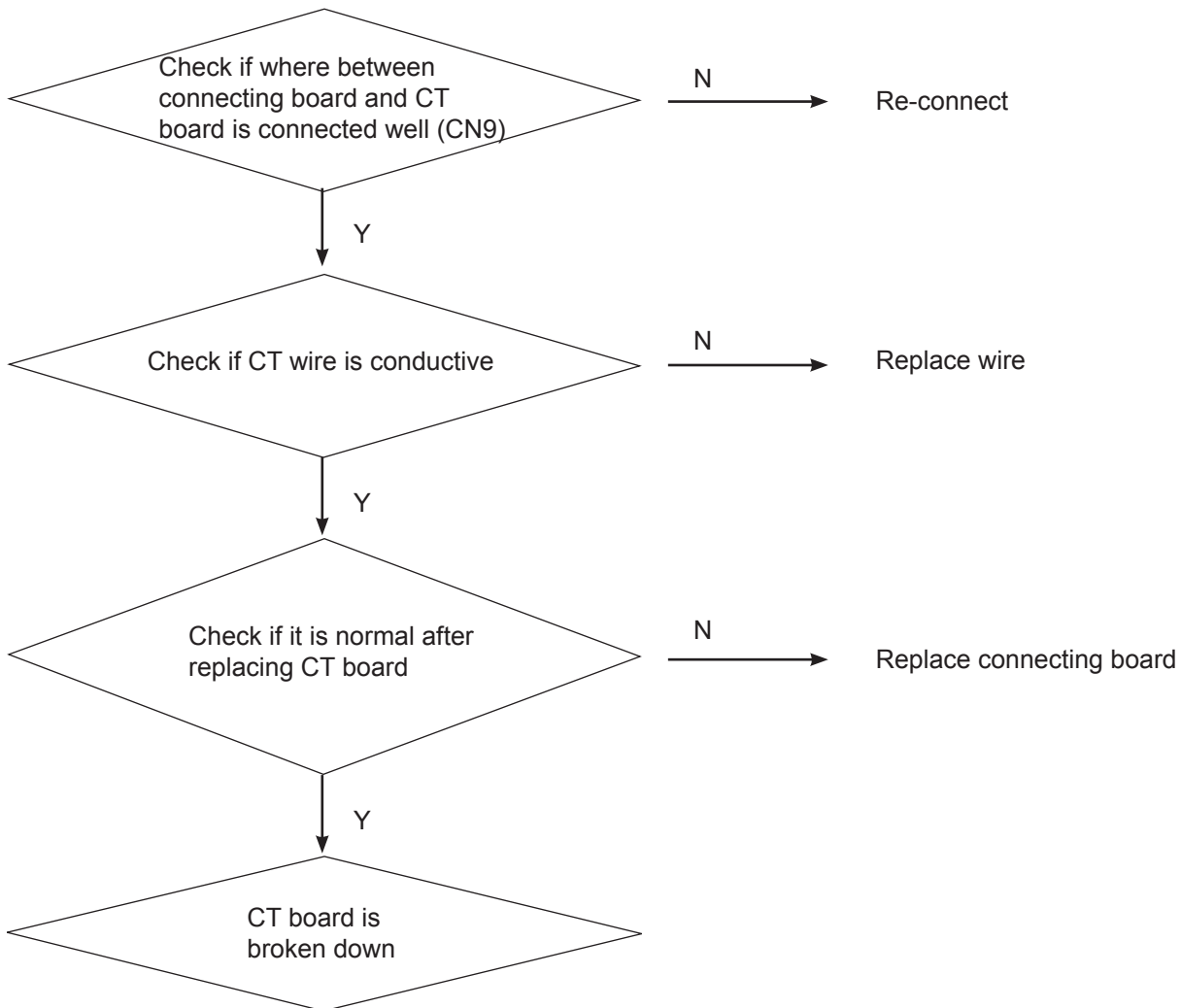

[64] CT current too high

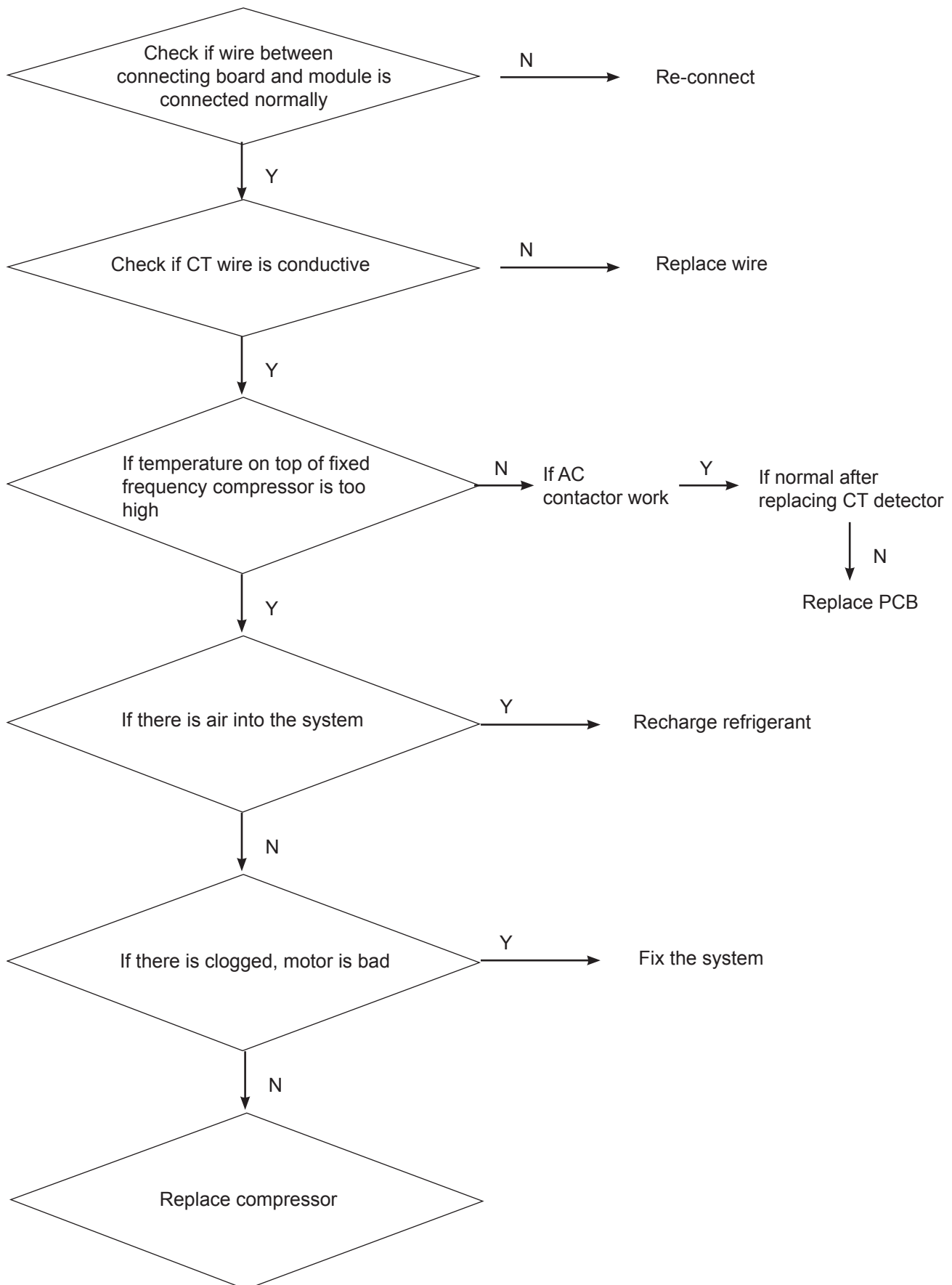

[71-0,71-1] DC motor blocked

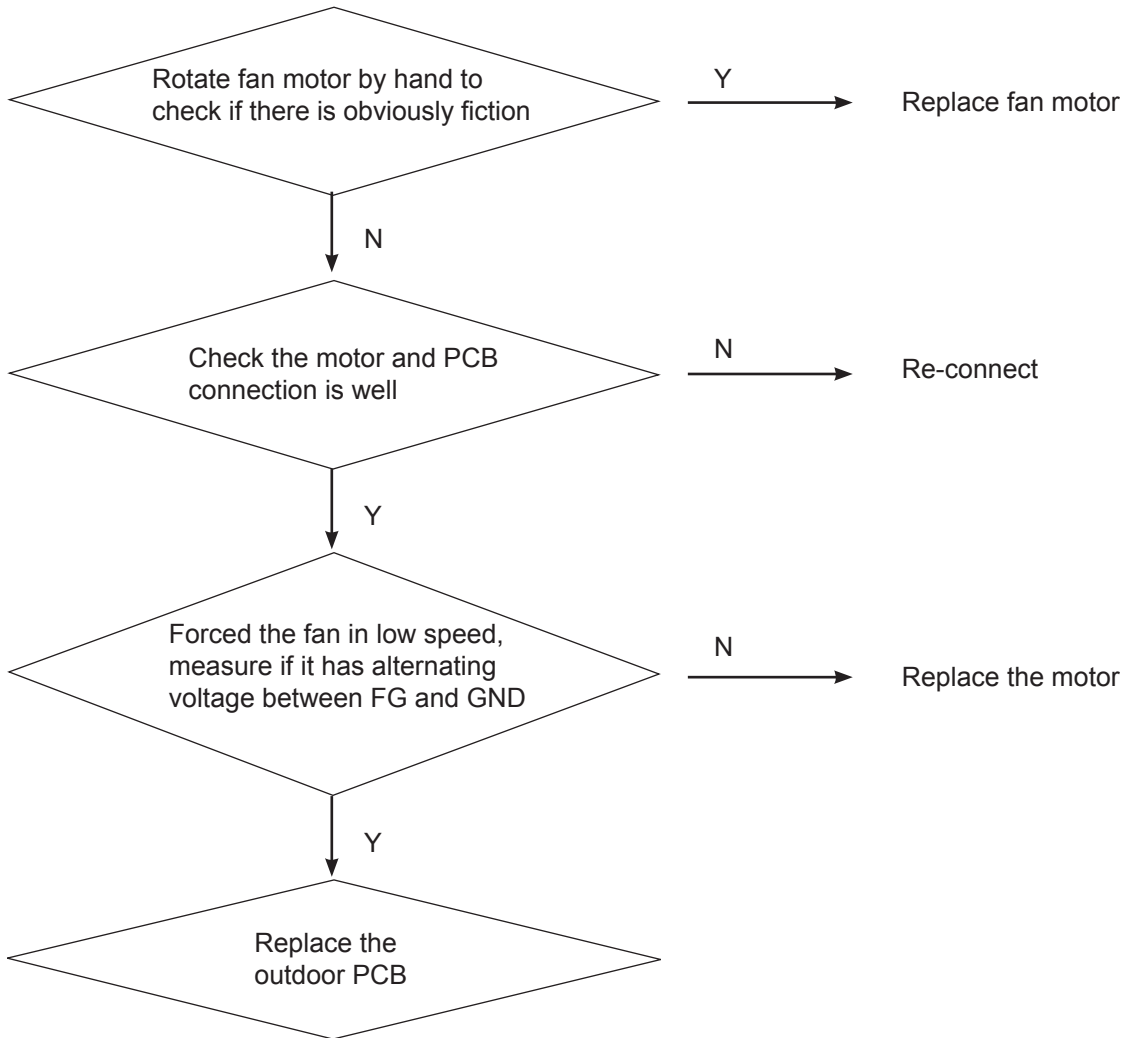

[75-0, 75-4] Pressure difference between high pressure and low pressure is abnormal

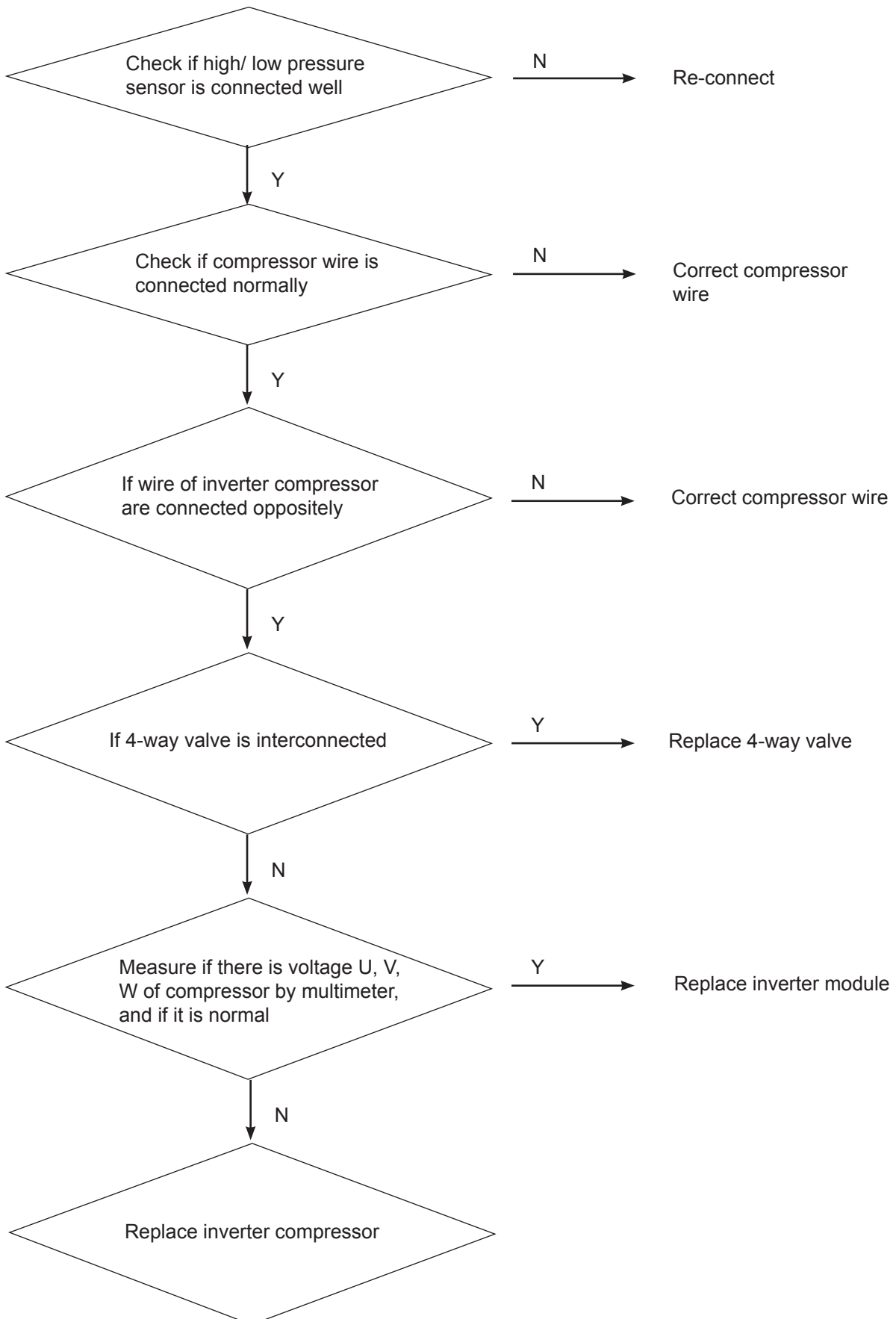

- [82] Compressor current protection
- [108] Transient over current in IPM module rectifier side software
- [110] IPM module hardware over current
- [123] Transient over current in IPM module rectifier side hardware

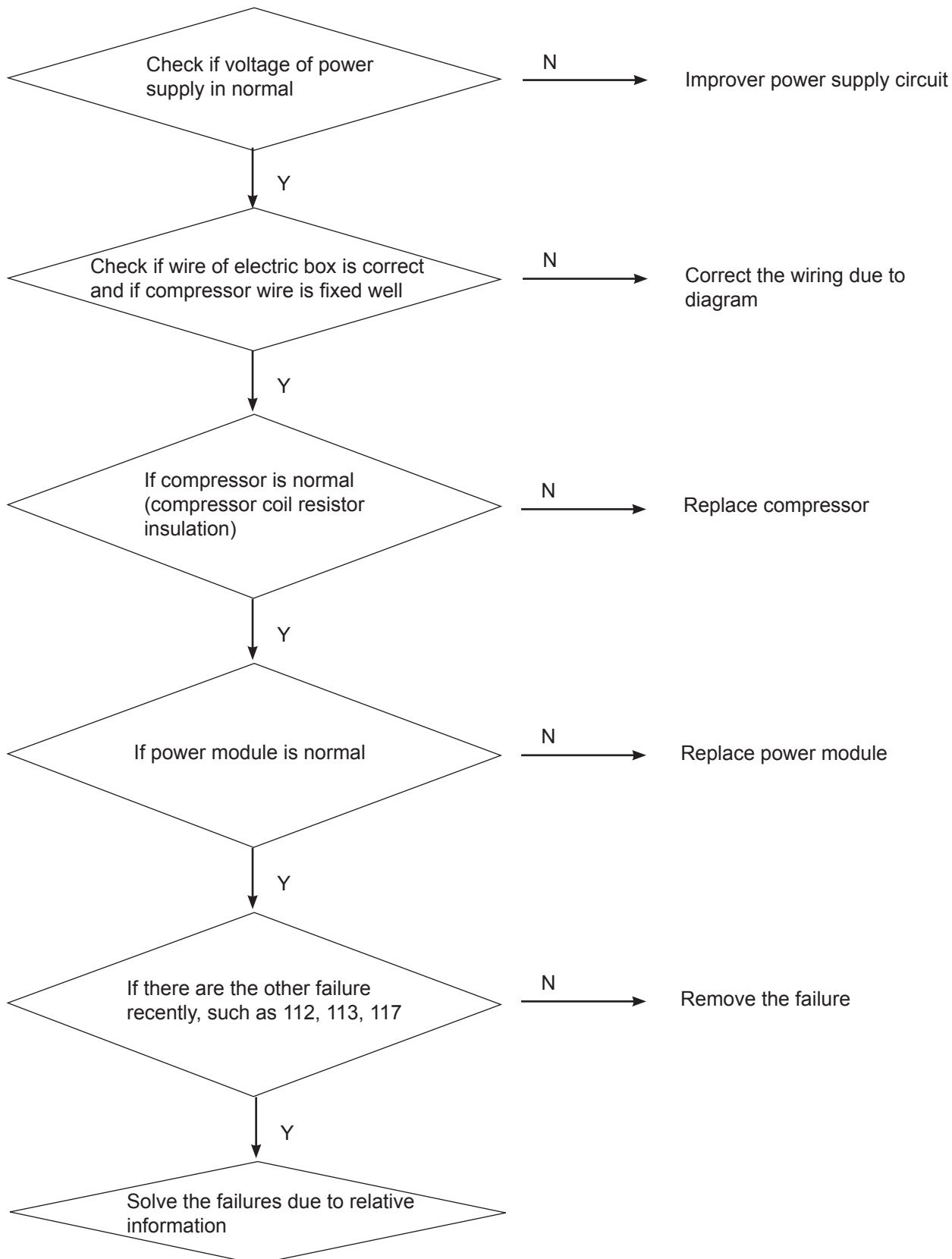

[111] Compressor out of control
[118] The compressor start failure

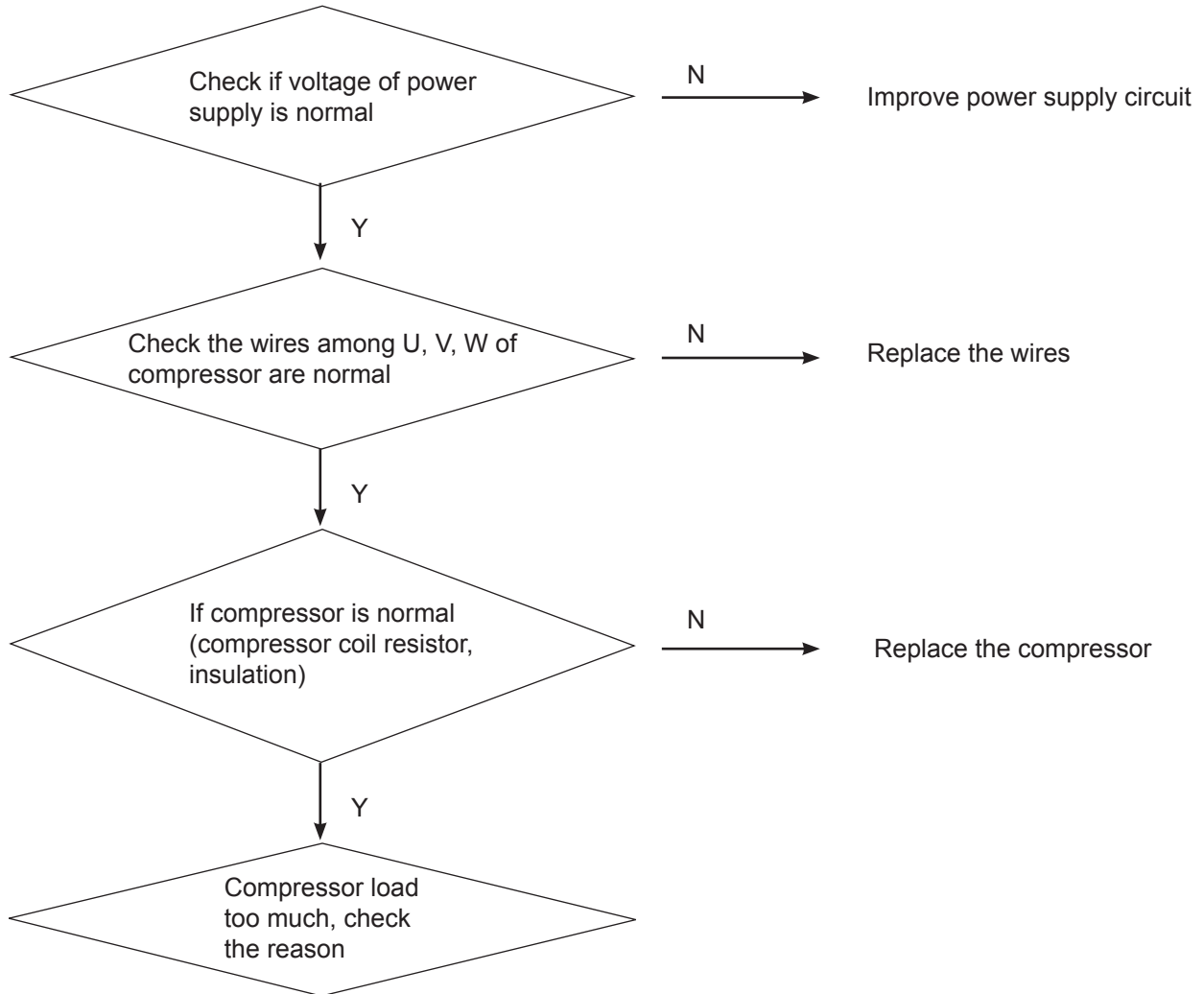

[112] Radiator temp. of transducer too high; [81] IPM module temp. too high

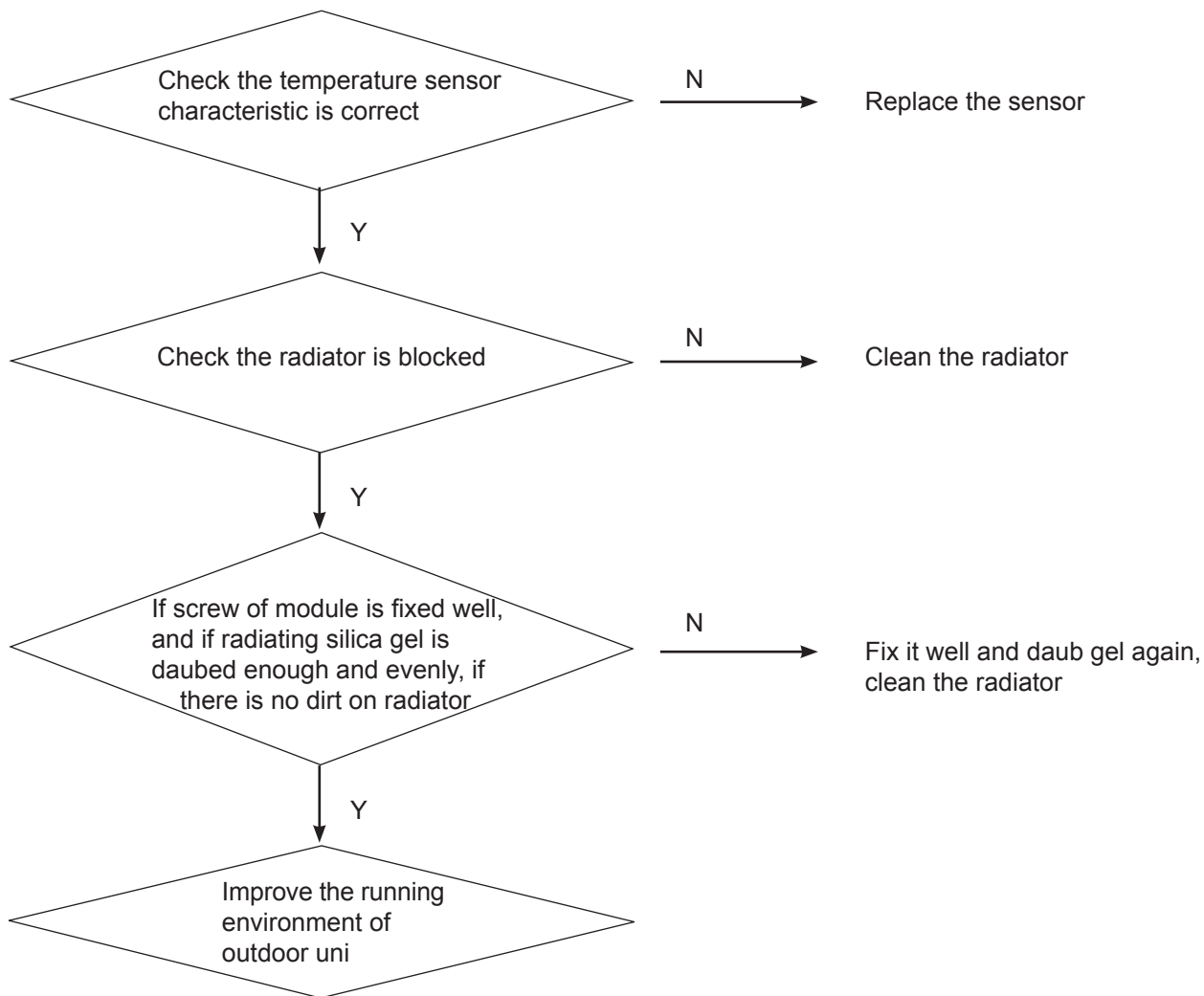

[113] Protection of overload

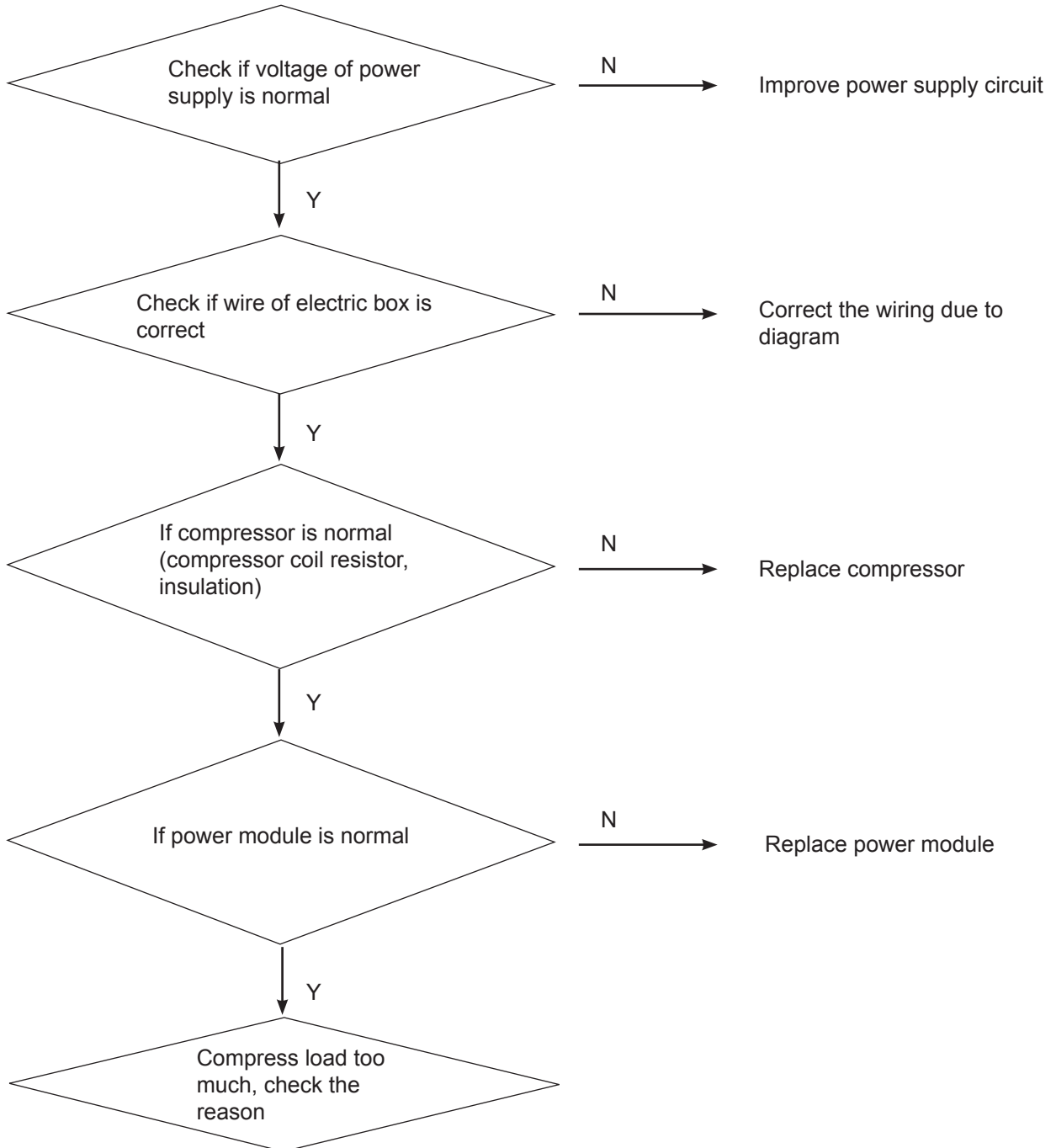

[114] Voltage too low of DC bus line of transducer

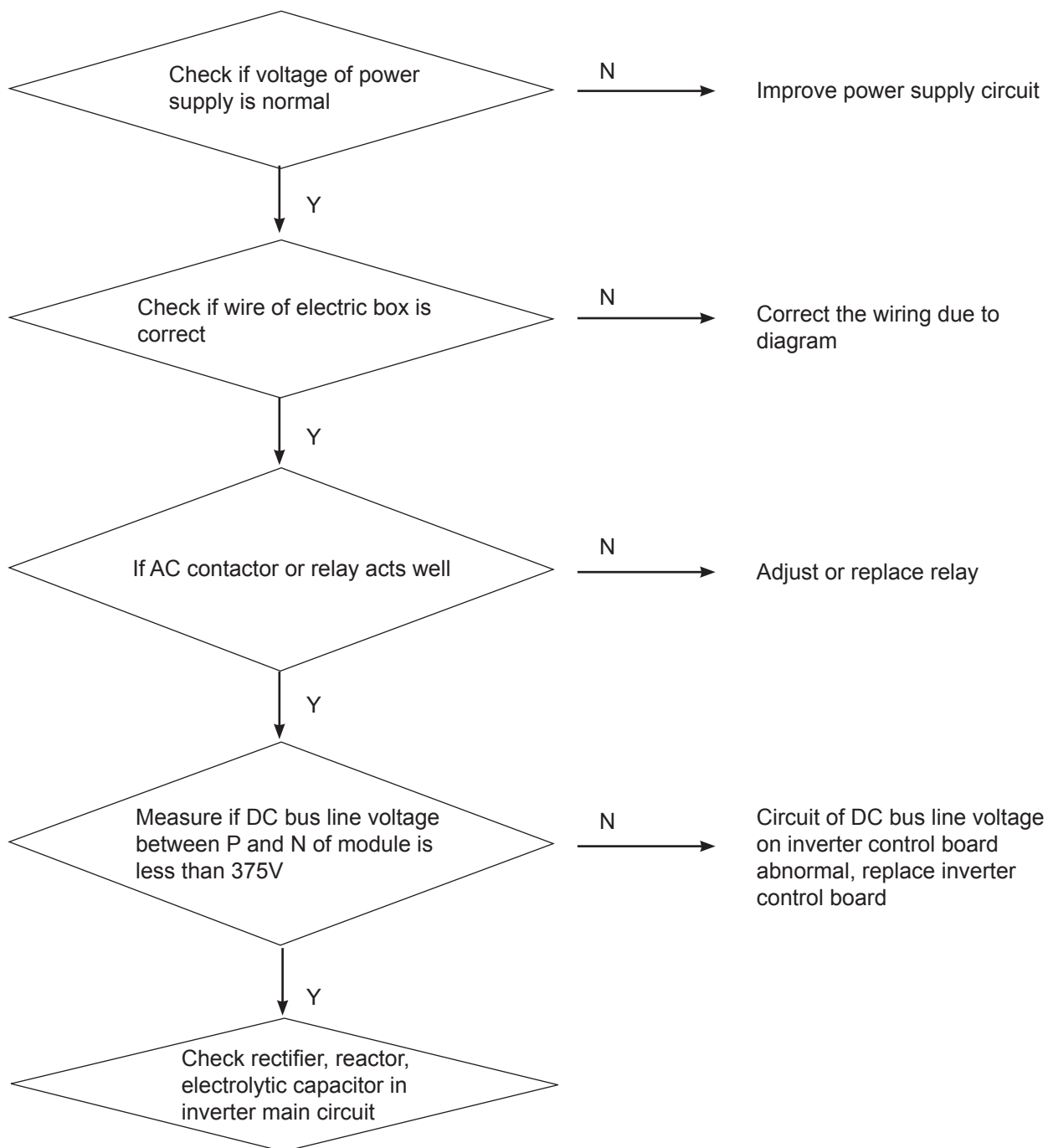

[115] Voltage too high of DC bus line of transducer

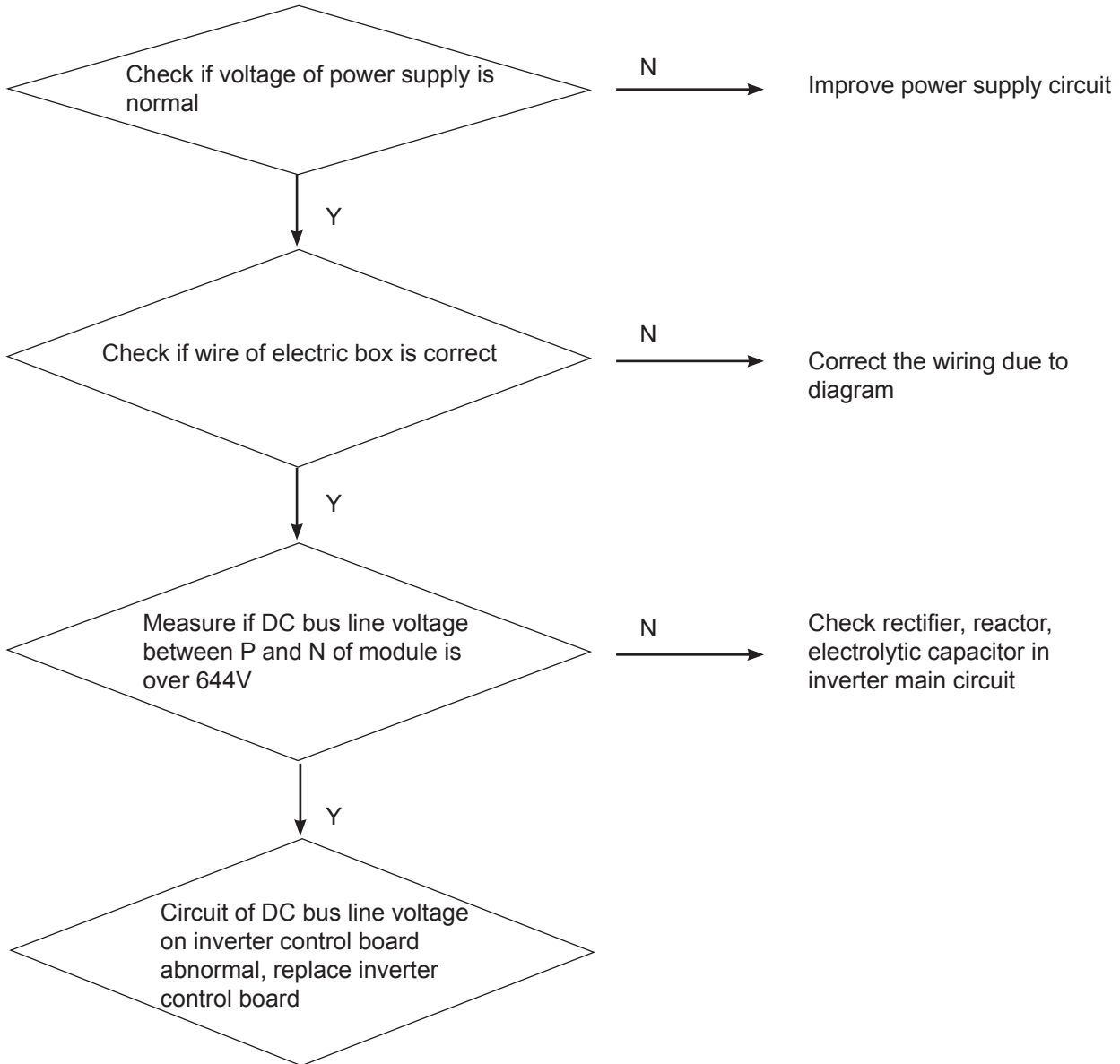

[116] Communication abnormal between transducer (inverter module board) and control PCB

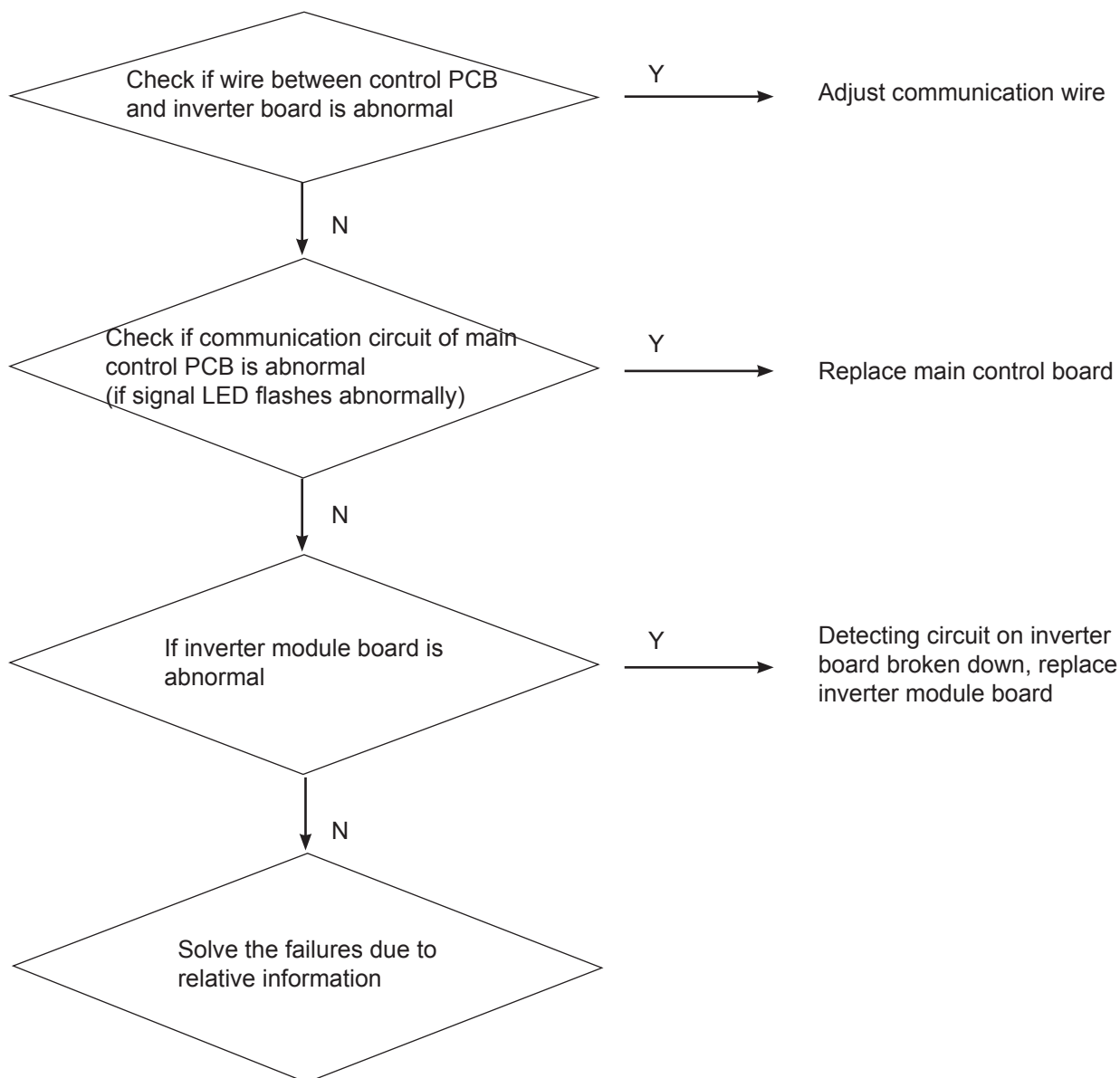

[117] Transducer over current (software protection)

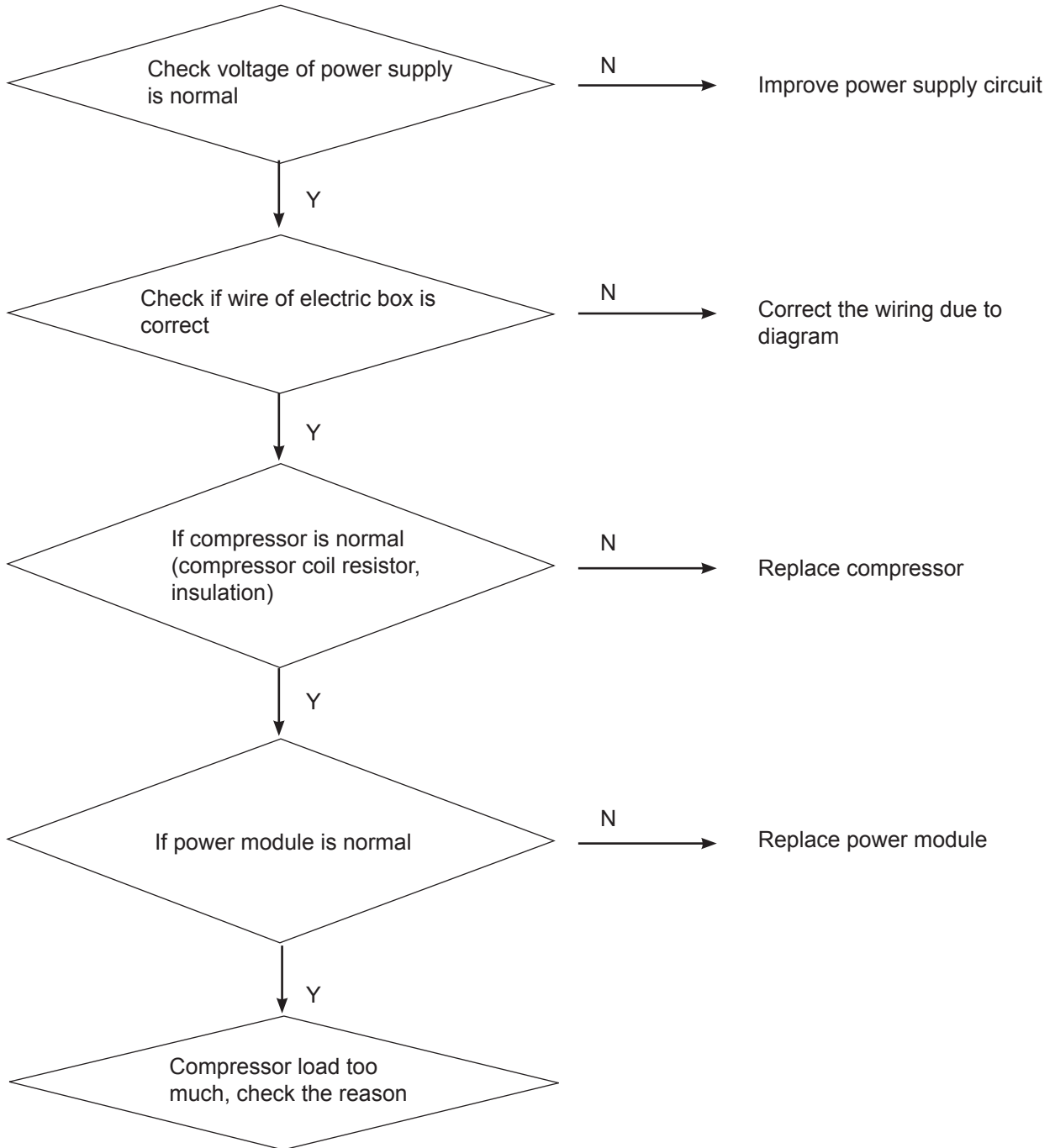

[119] Current detection circuit of transducer is abnormal

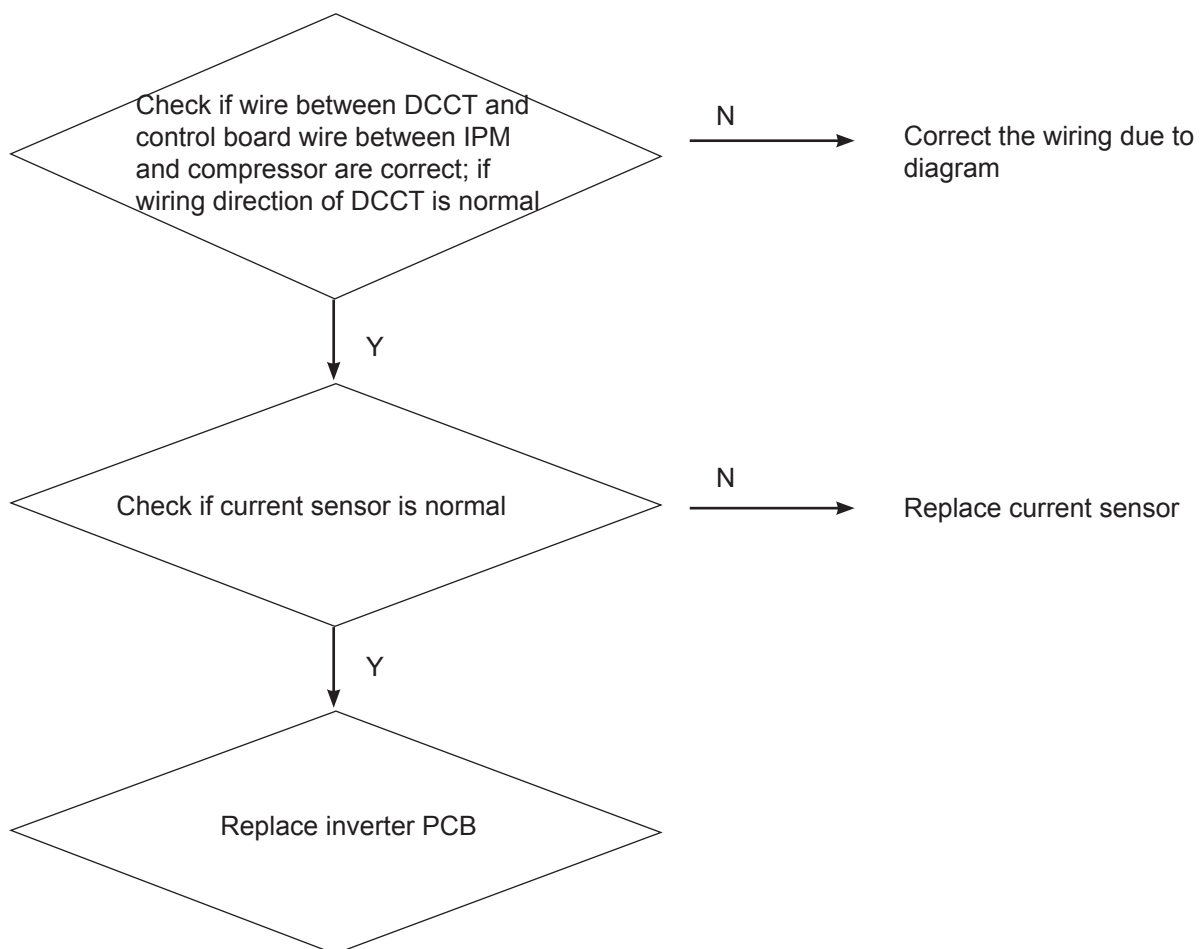

[120] Power supply of transducer abnormal

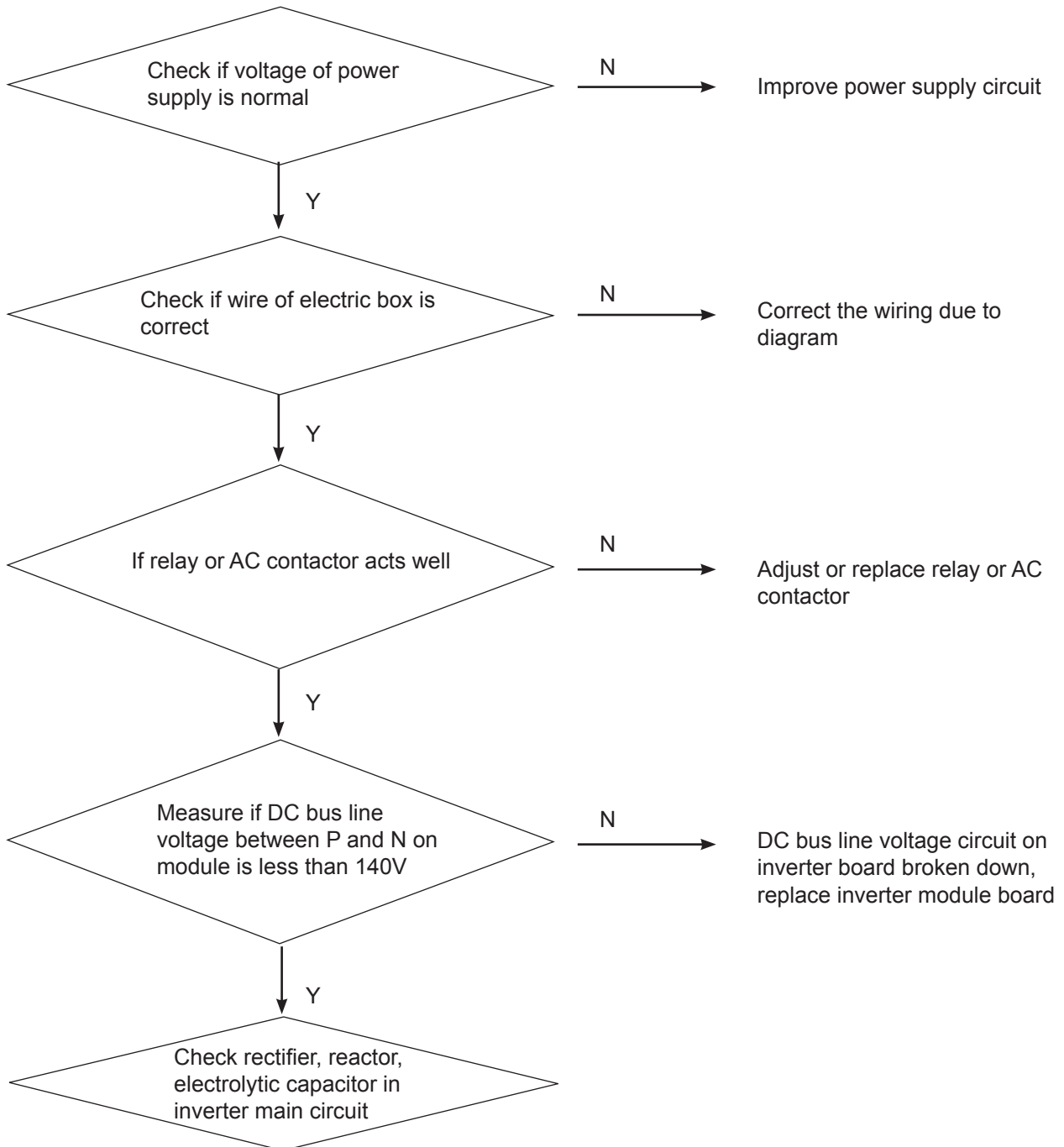

[121] Power supply of inverter board is abnormal

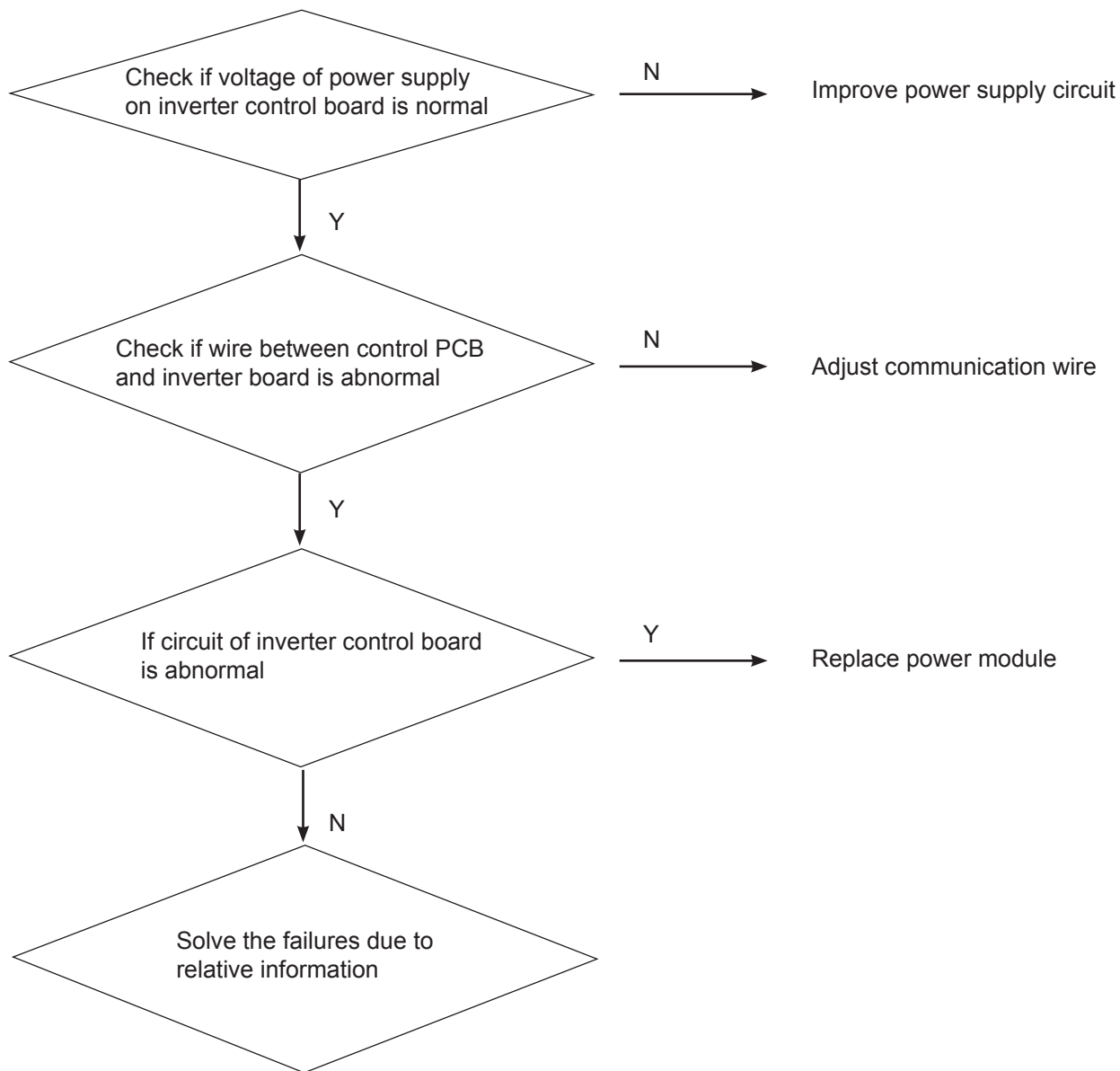

[122] Radiator temp. sensor of transducer abnormal

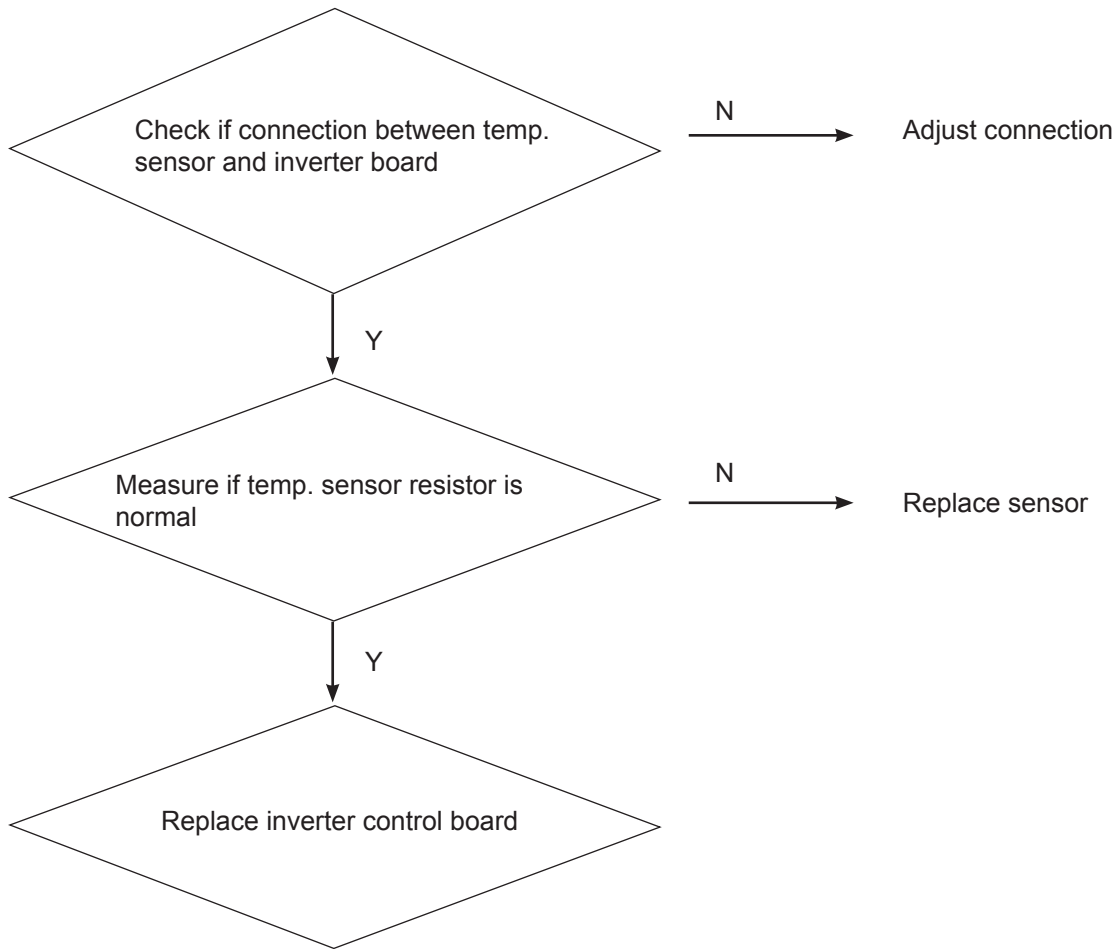

21. Sensor Resistance Table

NO.	Model	Part code	Name	Characteristic
1	AU082FRCRA(HW) AU112FRCRA(HW) AU162FRCRA(HW)	0150403185	TAO ambient temp. sensor	R25=10KΩ
2		0150403186	TD compressor discharge temp. sensor	R80=50KΩ
3		0150403187	TE1 defrosting temp. sensor	R25=10KΩ
4		0150403188	TS compressor suction temp. sensor	R25=10KΩ
5		0150403189	THI in refrigerant temp. sensor	R25=10KΩ
6		0150403190	THO out refrigerant temp. sensor	R25=10KΩ
7		0150403191	TWI in water temp. sensor	R25=10KΩ
8		0150403192	TWO out water temp. sensor	R25=10KΩ

R80=50kΩ±3% B25/80=4450K±3%					
Temp	Resistance (kΩ)			% (Resist. Tol)	
(°C)	Rmax	R (t) Normal	Rmin	MAX (+)	MIN (-)
0	1749.014	1921.993	2094.972	9	9
1	1651.431	1813.265	1975.099	8.93	8.93
2	1560.165	1711.646	1863.127	8.85	8.85
3	1474.737	1616.593	1758.449	8.78	8.78
4	1394.709	1527.611	1660.513	8.7	8.7
5	1319.683	1444.25	1568.817	8.63	8.63
6	1249.295	1366.096	1482.897	8.55	8.55
7	1183.21	1292.773	1402.336	8.48	8.48
8	1121.124	1223.935	1326.746	8.4	8.4
9	1062.756	1159.265	1255.774	8.33	8.33
10	1007.85	1098.474	1189.098	8.25	8.25
11	956.167	1041.293	1126.419	8.18	8.18
12	907.491	987.477	1067.463	8.1	8.1
13	861.621	936.799	1011.977	8.03	8.03
14	818.372	889.052	959.732	7.95	7.95
15	777.574	844.042	910.51	7.88	7.88
16	739.066	801.59	864.114	7.8	7.8
17	702.705	761.533	820.361	7.73	7.73
18	668.353	723.717	779.081	7.65	7.65
19	635.885	688.001	740.117	7.58	7.58
20	605.185	654.254	703.323	7.5	7.5
21	576.145	622.355	668.565	7.43	7.43
22	548.663	592.189	635.715	7.35	7.35
23	522.645	563.651	604.657	7.28	7.28
24	498.006	536.644	575.282	7.2	7.2
25	474.662	511.076	547.49	7.13	7.13
26	452.538	486.862	521.186	7.05	7.05
27	431.563	463.922	496.281	6.98	6.98
28	411.671	442.182	472.693	6.9	6.9
29	392.8	421.572	450.344	6.83	6.83
30	374.891	402.028	429.165	6.75	6.75
31	357.891	383.489	409.087	6.68	6.68
32	341.749	365.898	390.047	6.6	6.6
33	326.416	349.201	371.986	6.53	6.53
34	311.848	333.349	354.85	6.45	6.45
35	298.004	318.295	338.586	6.38	6.38
36	284.843	303.995	323.147	6.3	6.3

R80=50kΩ±3% B25/80=4450K±3%					
Temp	Resistance (kΩ)			% (Resist. Tol)	
(°C)	Rmax	R (t) Normal	Rmin	MAX (+)	MIN (-)
37	272.329	290.407	308.485	6.23	6.23
38	260.427	277.493	294.559	6.15	6.15
39	249.104	265.216	281.328	6.08	6.08
40	238.329	253.541	268.753	6	6
41	228.073	242.437	256.801	5.93	5.93
42	218.308	231.873	245.438	5.85	5.85
43	209.01	221.82	234.63	5.78	5.78
44	200.154	212.252	224.35	5.7	5.7
45	191.715	203.142	214.569	5.63	5.63
46	183.674	194.467	205.26	5.55	5.55
47	176.009	186.204	196.399	5.48	5.48
48	168.703	178.333	187.963	5.4	5.4
49	161.735	170.832	179.929	5.33	5.33
50	155.089	163.682	172.275	5.25	5.25
51	148.748	156.866	164.984	5.18	5.18
52	142.698	150.367	158.036	5.1	5.1
53	136.924	144.168	151.412	5.03	5.03
54	131.411	138.255	145.099	4.95	4.95
55	126.148	132.613	139.078	4.88	4.88
56	121.122	127.229	133.336	4.8	4.8
57	116.32	122.089	127.858	4.73	4.73
58	111.732	117.181	122.63	4.65	4.65
59	107.347	112.494	117.641	4.58	4.58
60	103.157	108.018	112.879	4.5	4.5
61	99.15	103.741	108.332	4.43	4.43
62	95.319	99.654	103.989	4.35	4.35
63	91.655	95.748	99.841	4.28	4.28
64	88.149	92.014	95.879	4.2	4.2
65	84.795	88.443	92.091	4.13	4.13
66	81.584	85.028	88.472	4.05	4.05
67	78.511	81.761	85.011	3.98	3.98
68	75.569	78.636	81.703	3.9	3.9
69	72.752	75.645	78.538	3.83	3.83
70	70.052	72.781	75.51	3.75	3.75
71	67.466	70.04	72.614	3.68	3.68

R80=50kΩ±3% B25/80=4450K±3%					
Temp	Resistance (kΩ)			% (Resist. Tol)	
(°C)	Rmax	R (t) Normal	Rmin	MAX (+)	MIN (-)
72	64.988	67.415	69.842	3.6	3.6
73	62.613	64.901	67.189	3.53	3.53
74	60.337	62.493	64.649	3.45	3.45
75	58.154	60.185	62.216	3.38	3.38
76	56.06	57.973	59.886	3.3	3.3
77	54.051	55.852	57.653	3.23	3.23
78	52.125	53.82	55.515	3.15	3.15
79	50.275	51.87	53.465	3.08	3.08
80	48.5	50	51.5	3	3
81	46.728	48.206	49.684	3.07	3.07
82	45.028	46.484	47.94	3.13	3.13
83	43.397	44.832	46.267	3.2	3.2
84	41.833	43.246	44.659	3.27	3.27
85	40.332	41.723	43.114	3.33	3.33
86	38.891	40.26	41.629	3.4	3.4
87	37.509	38.856	40.203	3.47	3.47
88	36.181	37.506	38.831	3.53	3.53
89	34.905	36.209	37.513	3.6	3.6
90	33.68	34.962	36.244	3.67	3.67
91	32.503	33.764	35.025	3.73	3.73
92	31.373	32.612	33.851	3.8	3.8
93	30.286	31.504	32.722	3.87	3.87
94	29.242	30.439	31.636	3.93	3.93
95	28.236	29.413	30.59	4	4
96	27.271	28.427	29.583	4.07	4.07
97	26.342	27.478	28.614	4.13	4.13
98	25.448	26.564	27.68	4.2	4.2
99	24.589	25.685	26.781	4.27	4.27
100	23.762	24.838	25.914	4.33	4.33
101	22.966	24.023	25.08	4.4	4.4
102	22.199	23.237	24.275	4.47	4.47
103	21.462	22.481	23.5	4.53	4.53
104	20.751	21.752	22.753	4.6	4.6

R80=50kΩ±3% B25/80=4450K±3%					
Temp	Resistance (kΩ)			% (Resist. Tol)	
(°C)	Rmax	R (t) Normal	Rmin	MAX (+)	MIN (-)
105	20.067	21.049	22.031	4.67	4.67
106	19.408	20.372	21.336	4.73	4.73
107	18.773	19.72	20.667	4.8	4.8
108	18.162	19.091	20.02	4.87	4.87
109	17.573	18.485	19.397	4.93	4.93
110	17.005	17.9	18.795	5	5
111	16.459	17.337	18.215	5.07	5.07
112	15.931	16.793	17.655	5.13	5.13
113	15.422	16.268	17.114	5.2	5.2
114	14.933	15.763	16.593	5.27	5.27
115	14.46	15.275	16.09	5.33	5.33
116	14.005	14.804	15.603	5.4	5.4
117	13.565	14.349	15.133	5.47	5.47
118	13.141	13.911	14.681	5.53	5.53
119	12.733	13.488	14.243	5.6	5.6
120	12.339	13.08	13.821	5.67	5.67
121	11.958	12.685	13.412	5.73	5.73
122	11.591	12.305	13.019	5.8	5.8
123	11.238	11.938	12.638	5.87	5.87
124	10.897	11.584	12.271	5.93	5.93
125	10.567	11.242	11.917	6	6
126	10.249	10.911	11.573	6.07	6.07
127	9.943	10.593	11.243	6.13	6.13
128	9.647	10.285	10.923	6.2	6.2
129	9.362	9.988	10.614	6.27	6.27
130	9.087	9.701	10.315	6.33	6.33
131	8.822	9.425	10.028	6.4	6.4
132	8.566	9.158	9.75	6.47	6.47
133	8.319	8.9	9.481	6.53	6.53
134	8.08	8.651	9.222	6.6	6.6
135	7.85	8.411	8.972	6.67	6.67
136	7.629	8.18	8.731	6.73	6.73
137	7.416	7.957	8.498	6.8	6.8
138	7.209	7.741	8.273	6.87	6.87
139	7.011	7.533	8.055	6.93	6.93
140	6.82	7.333	7.846	7	7

R25=10kΩ±3% B25/50=3700K±3%					
Temp	Resistance (kΩ)			% (Resist. Tol)	
(°C)	Rmax	R (t) Normal	Rmin	MAX (+)	MIN (-)
-30	145.819	135.018	124.217	7	7
-29	138.071	129.126	120.181	6.93	6.93
-28	131.793	123.339	114.885	6.85	6.85
-27	125.665	117.684	109.703	6.78	6.78
-26	119.706	112.18	104.654	6.71	6.71
-25	113.933	106.843	99.753	6.64	6.64
-24	108.361	101.687	95.013	6.56	6.56
-23	102.997	96.719	90.441	6.49	6.49
-22	97.847	91.946	86.045	6.42	6.42
-21	92.915	87.371	81.827	6.35	6.35
-20	88.2	82.994	77.788	6.27	6.27
-19	83.702	78.815	73.928	6.2	6.2
-18	79.417	74.832	70.247	6.13	6.13
-17	75.342	71.041	66.74	6.05	6.05
-16	71.471	67.437	63.403	5.98	5.98
-15	67.798	64.015	60.232	5.91	5.91
-14	64.316	60.769	57.222	5.84	5.84
-13	61.017	57.692	54.367	5.76	5.76
-12	57.895	54.778	51.661	5.69	5.69
-11	54.942	52.019	49.096	5.62	5.62
-10	52.149	49.409	46.669	5.55	5.55
-9	49.51	46.941	44.372	5.47	5.47
-8	47.016	44.607	42.198	5.4	5.4
-7	44.659	42.4	40.141	5.33	5.33
-6	42.433	40.315	38.197	5.25	5.25
-5	40.332	38.345	36.358	5.18	5.18
-4	38.346	36.482	34.618	5.11	5.11
-3	36.472	34.723	32.974	5.04	5.04
-2	34.7	33.059	31.418	4.96	4.96
-1	33.027	31.487	29.947	4.89	4.89
0	31.445	30	28.555	4.82	4.82
1	29.951	28.594	27.237	4.75	4.75
2	28.538	27.264	25.99	4.67	4.67
3	27.202	26.006	24.81	4.6	4.6
4	25.938	24.815	23.692	4.53	4.53

R25=10kΩ±3% B25/50=3700K±3%					
Temp	Resistance (kΩ)			% (Resist. Tol)	
(°C)	Rmax	R (t) Normal	Rmin	MAX (+)	MIN (-)
5	24.742	23.687	22.632	4.45	4.45
6	23.61	22.619	21.628	4.38	4.38
7	22.538	21.607	20.676	4.31	4.31
8	21.522	20.647	19.772	4.24	4.24
9	20.559	19.737	18.915	4.16	4.16
10	19.646	18.874	18.102	4.09	4.09
11	18.779	18.054	17.329	4.02	4.02
12	17.958	17.276	16.594	3.95	3.95
13	17.177	16.537	15.897	3.87	3.87
14	16.436	15.834	15.232	3.8	3.8
15	15.731	15.166	14.601	3.73	3.73
16	15.061	14.53	13.999	3.65	3.65
17	14.424	13.925	13.426	3.58	3.58
18	13.817	13.349	12.881	3.51	3.51
19	13.24	12.8	12.36	3.44	3.44
20	12.69	12.277	11.864	3.36	3.36
21	12.166	11.778	11.39	3.29	3.29
22	11.666	11.302	10.938	3.22	3.22
23	11.189	10.848	10.507	3.15	3.15
24	10.734	10.414	10.094	3.07	3.07
25	10.3	10	9.7	3	3
26	9.898	9.604	9.31	3.06	3.06
27	9.514	9.226	8.938	3.13	3.13
28	9.147	8.864	8.581	3.19	3.19
29	8.796	8.519	8.242	3.25	3.25
30	8.459	8.188	7.917	3.31	3.31
31	8.137	7.871	7.605	3.38	3.38
32	7.828	7.568	7.308	3.44	3.44
33	7.532	7.277	7.022	3.5	3.5
34	7.248	6.999	6.75	3.56	3.56
35	6.977	6.733	6.489	3.63	3.63
36	6.716	6.477	6.238	3.69	3.69
37	6.466	6.232	5.998	3.75	3.75
38	6.227	5.998	5.769	3.81	3.81
39	5.997	5.773	5.549	3.88	3.88
40	5.776	5.557	5.338	3.94	3.94
41	5.564	5.35	5.136	4	4

R25=10kΩ±3% B25/50=3700K±3%					
Temp	Resistance (kΩ)			% (Resist. Tol)	
(°C)	Rmax	R (t) Normal	Rmin	MAX (+)	MIN (-)
42	5.36	5.151	4.942	4.06	4.06
43	5.166	4.961	4.756	4.13	4.13
44	4.978	4.778	4.578	4.19	4.19
45	4.799	4.603	4.407	4.25	4.25
46	4.625	4.434	4.243	4.31	4.31
47	4.46	4.273	4.086	4.38	4.38
48	4.301	4.118	3.935	4.44	4.44
49	4.148	3.969	3.79	4.5	4.5
50	4.001	3.826	3.651	4.56	4.56
51	3.86	3.689	3.518	4.63	4.63
52	3.724	3.557	3.39	4.69	4.69
53	3.594	3.431	3.268	4.75	4.75
54	3.468	3.309	3.15	4.81	4.81
55	3.349	3.193	3.037	4.88	4.88
56	3.233	3.081	2.929	4.94	4.94
57	3.123	2.974	2.825	5	5
58	3.015	2.87	2.725	5.06	5.06
59	2.913	2.771	2.629	5.13	5.13
60	2.815	2.676	2.537	5.19	5.19
61	2.721	2.585	2.449	5.25	5.25
62	2.63	2.497	2.364	5.31	5.31
63	2.543	2.413	2.283	5.38	5.38
64	2.459	2.332	2.205	5.44	5.44
65	2.379	2.255	2.131	5.5	5.5
66	2.301	2.18	2.059	5.56	5.56
67	2.228	2.109	1.99	5.63	5.63
68	2.156	2.04	1.924	5.69	5.69
69	2.088	1.974	1.86	5.75	5.75
70	2.021	1.91	1.799	5.81	5.81
71	1.958	1.849	1.74	5.88	5.88
72	1.897	1.791	1.685	5.94	5.94
73	1.839	1.735	1.631	6	6
74	1.782	1.68	1.578	6.06	6.06
75	1.728	1.628	1.528	6.13	6.13

R25=10kΩ±3% B25/50=3700K±3%					
Temp	Resistance (kΩ)			% (Resist. Tol)	
(°C)	Rmax	R (t) Normal	Rmin	MAX (+)	MIN (-)
76	1.676	1.578	1.48	6.19	6.19
77	1.626	1.53	1.434	6.25	6.25
78	1.578	1.484	1.39	6.31	6.31
79	1.531	1.439	1.347	6.38	6.38
80	1.486	1.396	1.306	6.44	6.44
81	1.443	1.355	1.267	6.5	6.5
82	1.401	1.315	1.229	6.56	6.56
83	1.362	1.277	1.192	6.63	6.63
84	1.323	1.24	1.157	6.69	6.69
85	1.285	1.204	1.123	6.75	6.75
86	1.249	1.169	1.089	6.81	6.81
87	1.214	1.136	1.058	6.88	6.88
88	1.181	1.104	1.027	6.94	6.94
89	1.148	1.073	0.998	7	7
90	1.116	1.042	0.968	7.06	7.06
91	1.085	1.013	0.941	7.13	7.13
92	1.056	0.985	0.914	7.19	7.19
93	1.026	0.957	0.888	7.25	7.25
94	0.998	0.93	0.862	7.31	7.31
95	0.971	0.904	0.837	7.38	7.38
96	0.944	0.879	0.814	7.44	7.44
97	0.918	0.854	0.79	7.5	7.5
98	0.893	0.83	0.767	7.56	7.56
99	0.867	0.806	0.745	7.63	7.63
100	0.843	0.783	0.723	7.69	7.69
101	0.819	0.76	0.701	7.75	7.75
102	0.796	0.738	0.68	7.81	7.81
103	0.772	0.716	0.66	7.88	7.88
104	0.749	0.694	0.639	7.94	7.94
105	0.727	0.673	0.619	8	8

22. YR-E27 YR-E27A

22.1 Interface Display



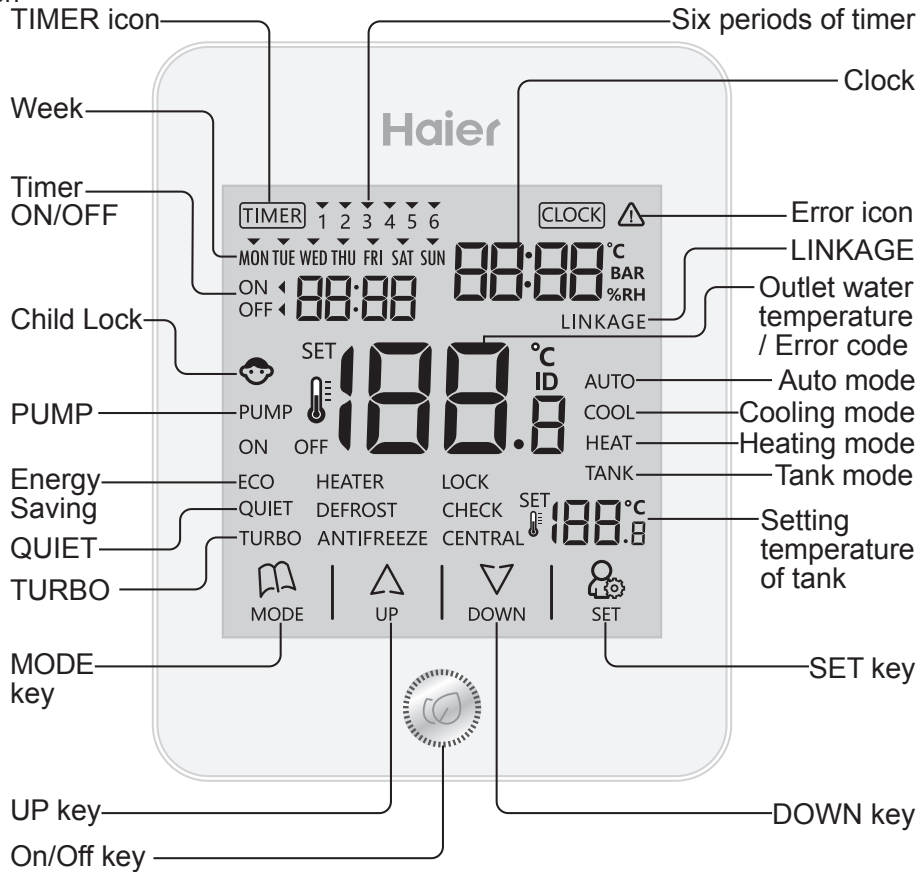

(1) Standard Version

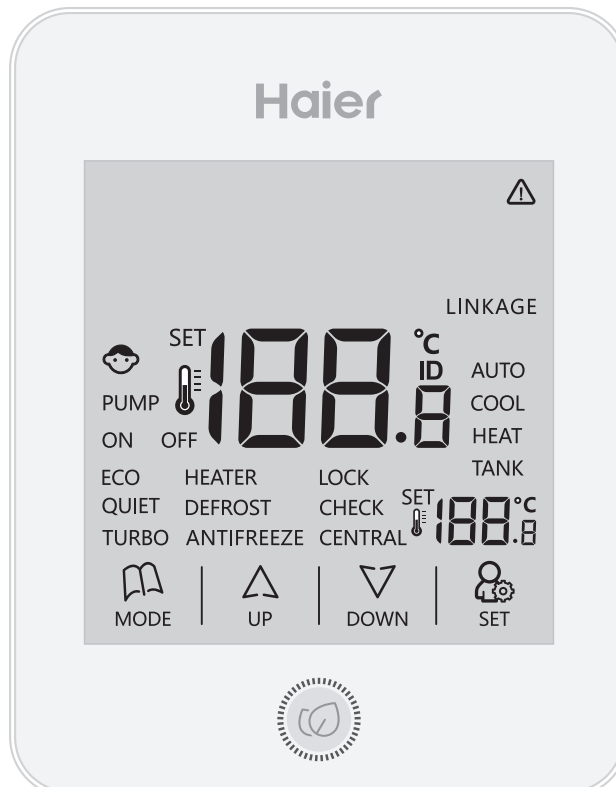



























(2) Simple Version



22.2 Key and Icon

	On/Off key.
 MODE	Mode key: Press this key to switch mode.
 UP	Up key: Press this key to adjust temperature in the main interface and other parameter value in other interface.
 DOWN	Down key: Press this key to adjust temperature in the main Interface and other parameter value in other interface.
 SET	Set key: Press this key to set special functions (ECO, QUIET and TURBO) and also can be combined with other keys for some other function settings.

	Outlet Water temperature display , Error code display
	Clock display , parameter display
	Timer: This icon will be displayed only when timer function is set.
	Six periods of timer
	Timer on/off and display the start time of next period of timer
	Week display
	Error icon
	Child Lock: This icon will be displayed only when child lock function is set.
	Pump: this icon will be displayed when pump is opened.
	On: This icon will be displayed when controller is turned on.

	Off: This icon will be displayed when controller is turned off.
	Energy Saving: This icon will be displayed only when energy saving function is set.
	Quiet: This icon will be displayed only when quiet is set.
	Turbo: This icon will be displayed only when turbo is chosen.
	Auto mode
	Cooling mode
	Heating mode
	Tank mode
	The setting temperature of the tank.
	Heater function
	Defrost icon
	Antifreeze icon
	Lock function
	Check function
	Central function
	Linkage function which is reserved

Note:

1. Setting range:

1) Tank mode: 25°C~75°C (the default is 42°C).

2) Cooling mode of air conditioning: water temperature 5°C~20°C (the default is 9°C).

3) For YR-E27: Heating mode of air conditioning: water temperature 25°C~55°C (the default is 40°C). Setting accuracy is 0.5°C.

For YR-E27A: water temperature 25°C~60°C (the default is 40°C). (the default is 40°C). Setting accuracy is 0.5°C.





2. Outlet water temperature display range: 0°C~100°C, display accuracy is 0.1°C.

3. The controller has two kinds of main display interface, standard version and simple version. The simple version has no timer, week, clock.











If you want to change the interface, you need to change the DIP switch (SW1-6) of the wired controller, and it will be effective after the system is powered again.











22.3 Operation

(1) Basic function description





Basic function description	Method of operation
ON/OFF	Press the key  to switch on/off the wired controller.
Mode control	In the state of on, press the key  to change mode. Whether there is "tank" mode or not depends on the indoor unit setting.
Adjusting setting temperature	In the state of on, press the key  or  to adjust the setting temperature.

(2) Special function index

Function	Method of operation
Forced to start pump (for debugging)	In the state of off, long press the key  for 15 seconds.
Set backlight time	In the state of off, press the key  and  for 5 seconds, 00 (stable lighting) /15S/30S/60S. Adjust the value by pressing the key  or  and confirm by pressing the key  .
Timer mode	Press the key  for 5 seconds to enter the timer ON/OFF setting, choose ON/OFF by pressing the key  or  and press the  to confirm.
Time setting	Press the key  for 10 seconds to enter into time setting function.

Function	Method of operation
Set parameter of timer	In the state of ON, long press the key  and  for 5 seconds to enter.
Check parameters and change functions (for debugging)	When the backlight is on, press the key  and  for 5 seconds to enter.
Set and cancel child lock	Press the key  and  for 10 seconds to set or cancel.
ECO(default) /QUIET/TURBO	In the state of on, press the key  to enter, switch by pressing the key  or  and confirm by pressing the key  again.

Setting special functions

In the state of on, press the key , then switch among ECO, QUIET and TURBO by pressing  or  key, finally press key  to confirm. If there is no key is pressed for 10 seconds, it will automatically exit and the previous setting is invalid.



Child lock

Press the key  and  for 10 seconds to set or cancel child lock. In the state of child lock, all keys are not available.



ON/OFF

Press the key  to switch on /off the wired controller.



Forced to start pump (for debugging)

In the state of off, press the key  for 15 seconds to enter and press the key  for 15 seconds again to exit.







Checking parameters and change functions (for debugging)

When the backlight is on, press the key  and  for 5 seconds to enter into this function's interface, which is available under the status of on or off.

(Some functions reserved, if the relevant device is not connected in the system, the relevant function code and machine number will not participate in the loop.)

(1) Press the key  or  to switch the function code, category A (Heat exchange unit)/ B (outdoor unit)/ C (indoor unit-- reserved)/ D (Module control board-- reserved)/ E (slave wired controller -- reserved).

(2) A/B is displayed after the decimal point in the intermediate temperature display area, function code (00-FF) is displayed in the lower right corner. 00-3F can be viewed and changed, while 40-FF can only be queried. The specific parameters are displayed in the upper right corner.

(3) Switch the function code by using the  or  key. If the function code is flashing, which means that it can be queried and can be changed. And if the function code is still, which means that it can only be queried. When the function code is flashing, press the  key to make the function code still. Meanwhile, the parameter value flashes to indicate that it can be changed. You can adjust the value by the  or  key. After adjustment, press the  key again and the parameter value will not flash. And the function code flashes, indicating that the previous layer operation is returned. If there is no operation for over 10 seconds, or press the SET key in the state of viewing the parameter (when function code is 40-7F), exit the parameter viewing and setting interface. And you can also exit this interface by pressing on/off key.

(4) If there is no reply from the air-condition, the parameter display will be "--". If the communication returns that defrost, check or antifreeze is running, relevant icon will display

Category	Function code	Function description	Set/ Query
A	00	ON/OFF	Can be queried and set
A	01	Setting mode	Can be queried and set
A	02	temperature setting	Can be queried and set
A	03	Temperature compensation	Can be queried and set
A	04	Electric heating	Can be queried and set
A	05	Pump	Can be queried and set
A	06	Centralized controller group number	Can be queried and set
A	07	Rust prevention operation	Can be queried and set
A	08	Floor dry	Query only
A	09	Check 1	Can be queried and set
A	0A	Check 2	Can be queried and set
A	0B-3F Reserved	Reserved function, does not participate in the loop when the function code loops	Can be queried and set
A	40	Type of heat exchange unit	Query only
A	41	Operation mode	Query only
A	42	Antifreeze	Query only
A	43	Rust prevention operation	Query only
A	44	Defrost	Query only
A	45	Current fault	Query only
A	46	Number of connected indoor controllers	Query only
A	47	Number of connected indoor controllers that is on.	Query only
A	48	Number of connected indoor controllers that is thermo. on.	Query only
A	49	Power	Query only
A	4A	Electric heating state	Query only
A	4B	Pump state	Query only
A	4C	Micro switch	Query only

Category	Function code	Function description	Set/ Query
A	4D	Pressure difference switch	Query only
A	4E	Two-way valve chain	Query only
A	4F	Low voltage switch	Query only
A	50	Internal machine regulating valve target overheating (undercooling) degree	Query only
A	51	PMV opening degree	Query only
A	52	Heat exchange unit antifreeze temperature Tz	Query only
A	53	Heat exchange unit inlet water temperature Twi	Query only
A	54	Heat exchange unit outlet water temperature Two	Query only
A	55	Heat exchanger unit refrigerant liquid pipe temperature Thi	Query only
A	56	Heat exchanger unit refrigerant gas pipe temperature Tho	Query only
A	57	Cumulative running time	Query only
A	58	Continuous running time	Query only
A	59	Program version number	Query only
A	5A	E2 version	Query only
A	5B	Historical error 1	Query only
A	5C	Historical error 2	Query only
A	5D	Historical error 3	Query only
A	5E-FF Reserved	Reserved function, does not participate in the loop when the function code loops	Query only
B	00-3F Reserved	Reserved function, does not participate in the loop when the function code loops	Can be queried and set
B	40	Operation mode	Query only
B	41	Outdoor unit quiet	Query only
B	42	Defrost	Query only
B	43	Current outdoor unit error code	Query only
B	44	Type of outdoor unit	Query only
B	45	Power supply voltage type	Query only
B	46	Power frequency type	Query only

Category	Function code	Function description	Set/ Query
B	47	Horse power	Query only
B	48	Compressor target operating frequency	Query only
B	49	Actual operating frequency of the compressor	Query only
B	4A	Speed of fan 1	Query only
B	4B	Speed of fan 2	Query only
B	4C	Electronic expansion valve opening degree	Query only
B	4D	Target Pd	Query only
B	4E	Actual Pd	Query only
B	4F	Saturation temperature of Target Pd	Query only
B	50	Saturation temperature of actual Pd	Query only
B	51	Target Ps	Query only
B	52	Actual Ps	Query only
B	53	Saturation temperature of Target Ps	Query only
B	54	Saturation temperature of actual Ps	Query only
B	55	Temperature of Td	Query only
B	56	Temperature of Ts	Query only
B	57	Temperature of Tao	Query only
B	58	Temperature of Tdef	Query only
B	59	Temperature of Toil	Query only
B	5A	Compressor module temperature	Query only
B	5B	Compressor current	Query only
B	5C	Compressor DC voltage	Query only
B	5D	Cumulative running time	Query only
B	5E	Continuous running time	Query only
B	5F	Program version number	Query only
B	60	E2 version	Query only



















Category	Function code	Function description	Set/ Query
B	61	Historical error 1 of outdoor unit	Query only
B	62	Historical error 2 of outdoor Unit	Query only
B	63	Historical error 3 of outdoor Unit	Query only
B	64-FF Reserved	Reserved function, does not participate in the loop when the function code loops	Query only

















(5) Timer

Note: This function is not available when the dial code is simple.

In the on state, press the key  and  for 5 seconds to enter this function interface.

The default values are as follows

Week icon	Time period	Default start time	Default switch	Default temperature
		6:00	ON	Cooling mode: 9°C; Heating mode: 40°C; Hot water: 42°C.
		8:00	OFF	Cooling mode: 9°C; Heating mode: 40°C; Hot water: 42°C.
		12:00	ON	Cooling mode: 9°C; Heating mode: 40°C; Hot water: 42°C.
		13:00	OFF	Cooling mode: 9°C; Heating mode: 40°C; Hot water: 42°C.
		18:00	ON	Cooling mode: 9°C; Heating mode: 40°C; Hot water: 42°C.
		22:00	ON	Cooling mode: 9°C; Heating mode: 40°C; Hot water: 42°C.
		8:00	ON	Cooling mode: 9°C; Heating mode: 40°C; Hot water: 42°C.
		9:00	OFF	Cooling mode: 9°C; Heating mode: 40°C; Hot water: 42°C.
		12:00	ON	Cooling mode: 9°C; Heating mode: 40°C; Hot water: 42°C.

Week icon	Time period	Default start time	Default switch	Default temperature
		13:00	OFF	Cooling mode: 9°C; Heating mode: 40°C; Hot water: 42°C.
		18:00	ON	Cooling mode: 9°C; Heating mode: 40°C; Hot water: 42°C.
		22:00	ON	Cooling mode: 9°C; Heating mode: 40°C; Hot water: 42°C.
		8:00	ON	Cooling mode: 9°C; Heating mode: 40°C; Hot water: 42°C.
		9:00	OFF	Cooling mode: 9°C; Heating mode: 40°C; Hot water: 42°C.
		12:00	ON	Cooling mode: 9°C; Heating mode: 40°C; Hot water: 42°C.
		13:00	OFF	Cooling mode: 9°C; Heating mode: 40°C; Hot water: 42°C.
		18:00	ON	Cooling mode: 9°C; Heating mode: 40°C; Hot water: 42°C.
		22:00	ON	Cooling mode: 9°C; Heating mode: 40°C; Hot water: 42°C.

After entering the setting interface, the week display area displays the week character, and the time period value is displayed above it.







You can switch between the time periods by using the UP and DOWN keys. You can also quickly switch between weeks by pressing the MODE key.

In the display state of a certain period of time, press the SET key to enter the parameter settings. You can switch the hour, minute, on/off, and temperature by the MODE or SET key. Switch to the corresponding position, its parameters flashing, indicating that it can be changed. Using the up and down keys to change its parameter value. Pressing the mode or set key to switch will save the previous settings.

If there is no operation for 10 seconds or if the ON/OFF key is pressed, the function will be exited and the last changed parameter will not be saved.

22.4 Week and clock function settings

Note: This function is not available when the dial code is simple.

Enter the week and clock setting by pressing and holding the  key for 10 seconds. After you enter this function,  icon and the current value in  flashes, pressing UP and DOWN keys to change the week value. By pressing the  key to switch to the hour setting, the hour value flashes at this time, you can change the parameter by the UP and DOWN keys. Then press the  key to switch to the minute setting, the minute value flashes, you can change the minute value by using the UP and DOWN keys and press the  key to confirm the change. If there is no operation for 10 seconds, the function will be exited and the last changed parameter will not be saved.

22.5 Dip switch

SW1	Definition content	Specific definition
1	Reserved	Reserved
2	Whether to display the outlet water temperature	ON -- do not display OFF -- display
3	Whether it is the demo version	ON -- demo version OFF -- Non-demo version
4	Single cooling	ON -- Single cooling OFF -- normal
5	Single heating	ON -- Single heating OFF -- normal
6	Simple	ON -- simple OFF -- normal
7	Reserved	Reserved
8	Reserved	Reserved

22.6 Wired Controller Wiring Instruction

1. First, put communication wire through the hole in the backplane.

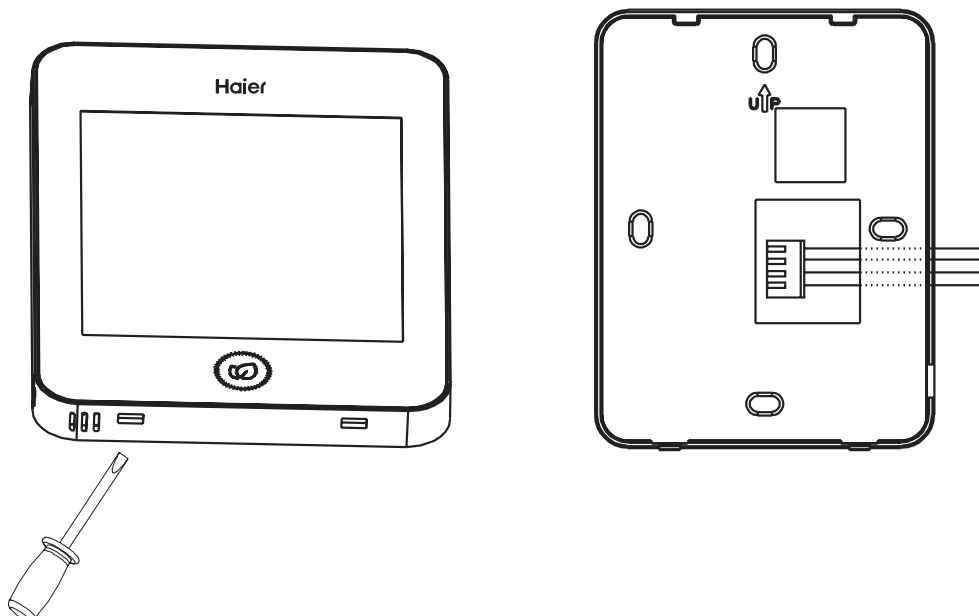

2. Fix backplane and then connect communication wire to CN1 port of wired controller. Finally put the front cover of wired controller to backplane to complete the installation.

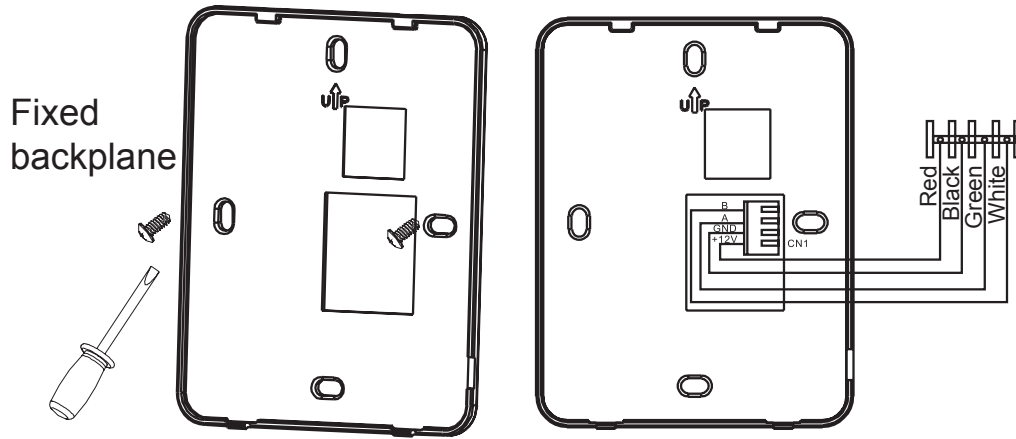

23. ATW-A01

23.1 Introduction

In order to facilitate the installation and reduce the connection between the equipment and the unit, the ATW-A01 is specially developed. The ATW-A01 can be installed in the equipment room. It can accept external control signals, output the the operation status of equipment, and control the ON/ OFF of the valves and switches which is in the system.

23.2 Appearance

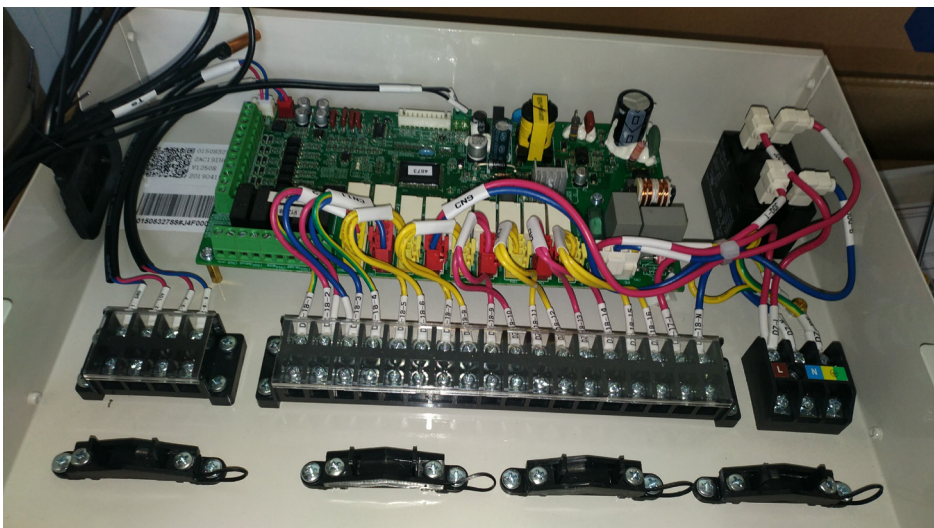

23.3 Specification

Model		ATW-A01
Serial number		AA2JT5E29
Power supply	V-Ph-Hz	220-240V-1-50/60HZ
Net dimension (W×H×D)	mm	390×80×255
Packing dimension(W×H×D)	mm	471×120×288
Net weight	kg	2.65
Gross weight	kg	3
Connectable unit number	Piece	1

23.4 Dimension

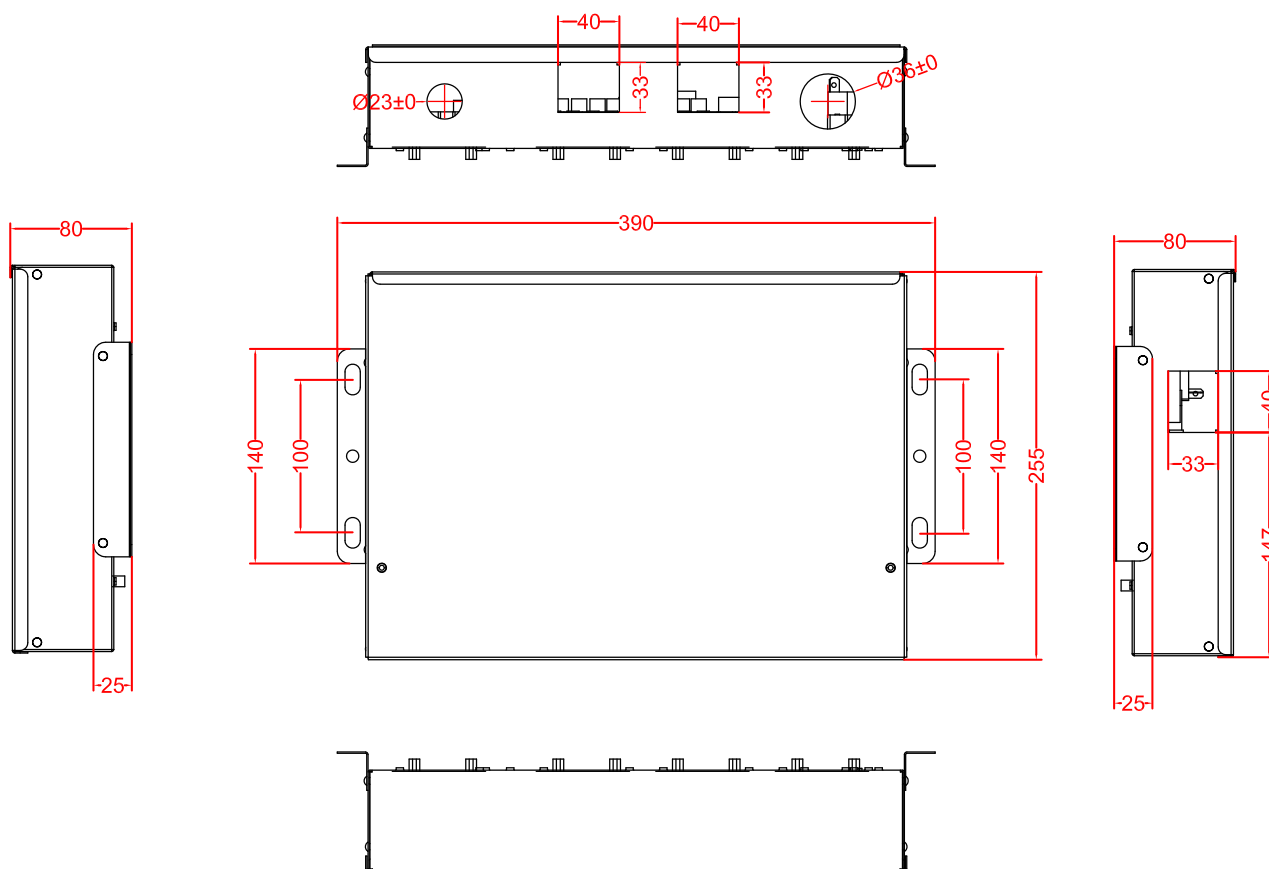

23.5 PCB photo

PCB code: 0151800430



23.6 Wiring diagram

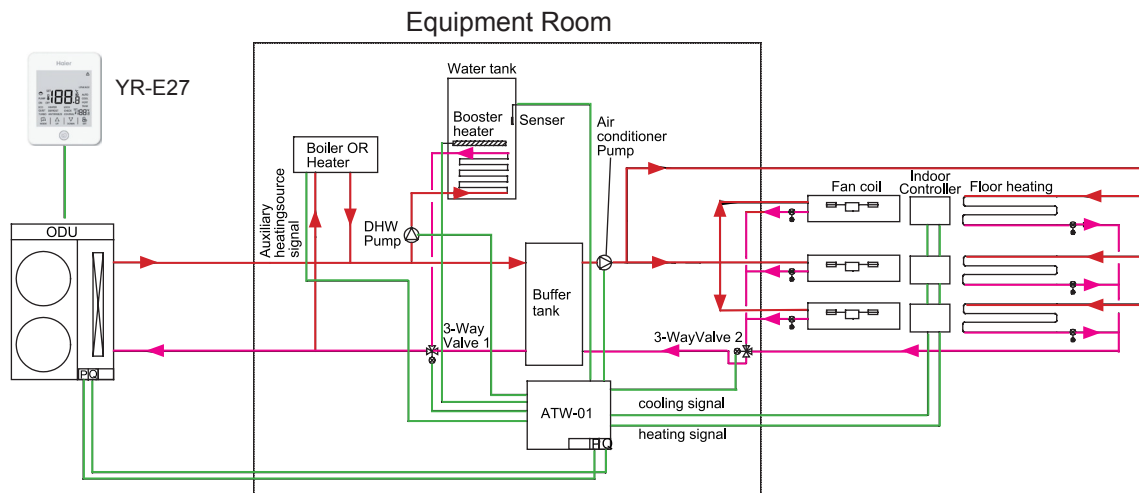

Fig.1 DHW (domestic hot water) controlled by YR-E27

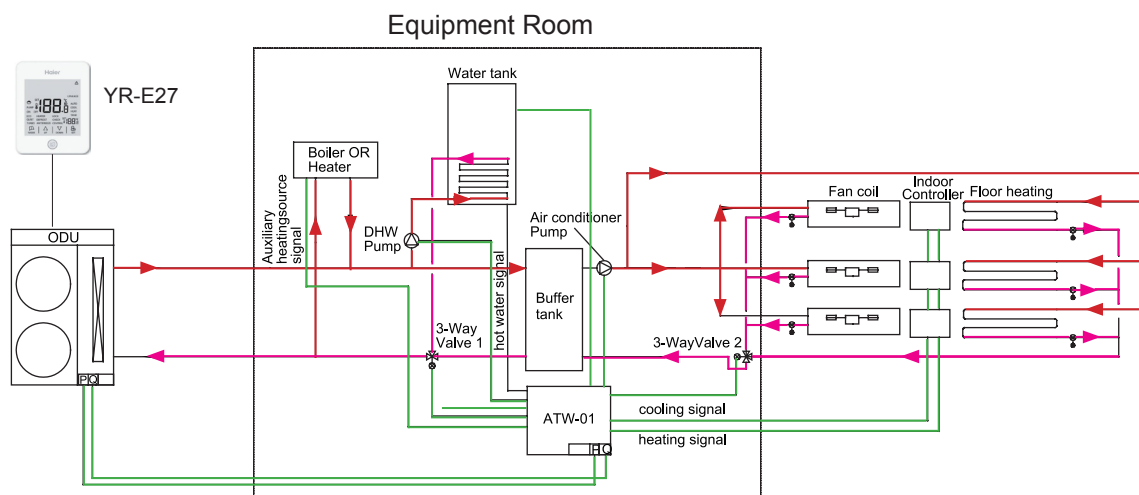
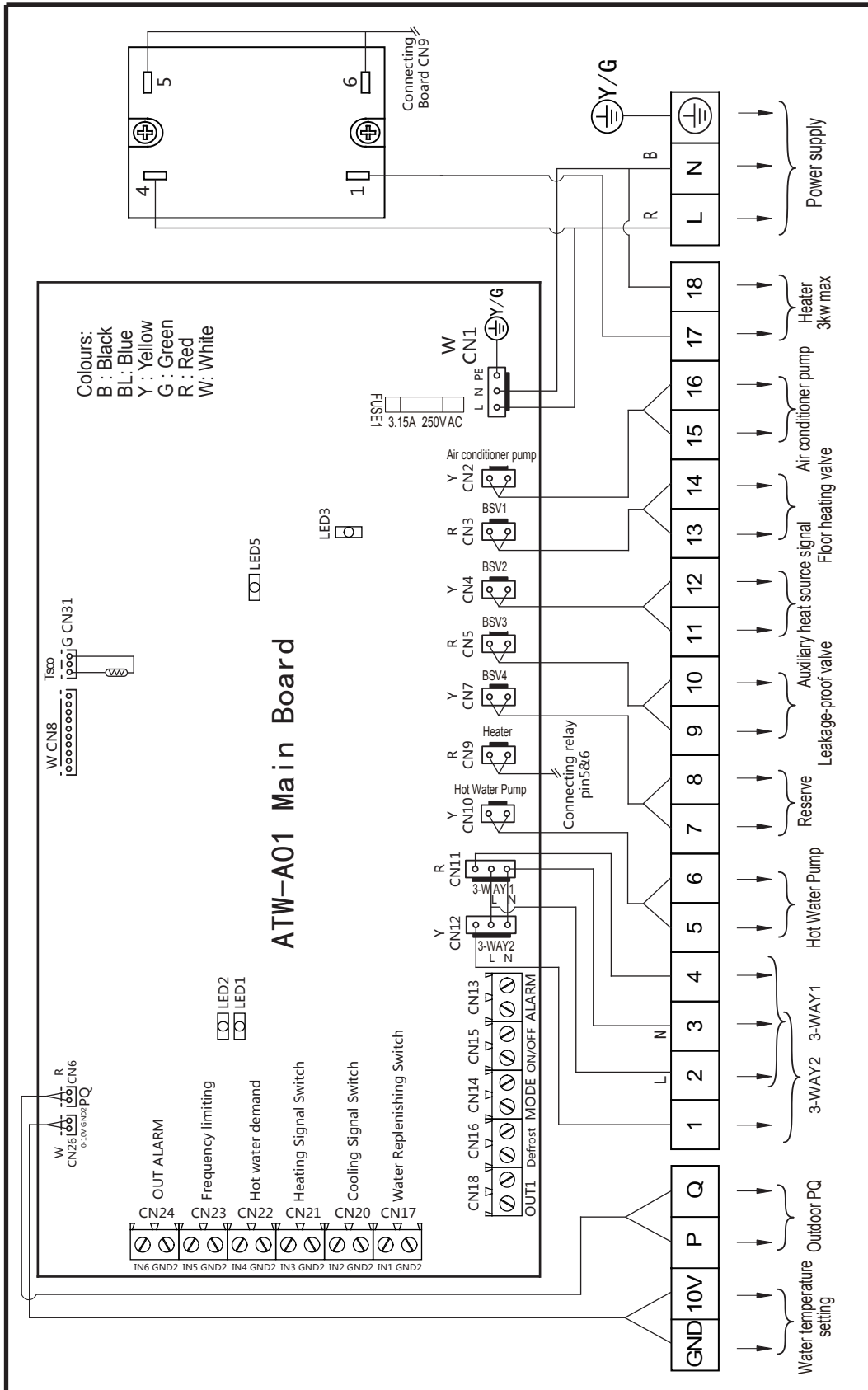

Fig.2 DHW (domestic hot water) controlled by user's controller

- Water supply pipe
- Water return pipe
- Signal wire

Before connecting the ATW-A01, please set the outdoor unit first, open the outdoor unit casing and the control box, then setting the board dial switch, make the BM1-1&1-8&2-8 as follows:

1. If the outdoor unit connect with ATW-A01, make the outdoor's BM1-8 to ON.
2. If DHW function is activated, Outdoor PCB set BM2-8 to on and two options as follow:
 - YR-E27 together with DHW temperature sensor (Connected at CN31) which will be inserted into DHW tank while Outdoor PCB BM1-1 will be set to OFF (Fig.1);
 - User sends on/off to CN22 while outdoor PCB BM1-1 will be set to ON (Fig.2).



Signal input in ATW-A01

NO.	Input Description	Remarks	Characteristic	
CN 31	Water tank temperature sensor	When use YR-E27 to control DHW check the temperature of water tank	R(25°C)=10KΩ B (25°C /50°C) =3700 K	When use YR-E27 control DHW, the tank temperature sensor is needed, and BM1-1 need OFF, then YR-E27 can control, separate from CN22.
CN 8		Reserved		
CN 6	PQ	Communication with outdoor	Communication signal	
CN 26	Water temperature setting(0~+10V)	Reserved	Reserved	
CN 24	OUT ALARM	When the dry contact is ON, the outdoor will stop	Dry contact signal, no voltage	Manually control, when get ON signal, ODU will stop operation, meanwhile CN13 will give power, so IDU will also stop
CN 23	Frequency limiting	When the indoor unit temperature or hot water tank temperature reach the setting temperature, the dry contact is ON, the outdoor's output will reduce.	Dry contact signal, the unit's maximum operating frequency is reduced by 50%	
CN 22	Hot water demand	When use the user's own controller to control DHW	Dry contact signal, no voltage	When user control DHW by themselves, short connect CN22, and BM1-1 need ON, then ATW-A01 can control, separate from CN31.
CN 21	Heating signal switch	When there is heating demand, the dry contact is ON, otherwise is OFF(signal is from user controller)	Dry contact signal, no voltage	When YR-E27 and CN21/CN20 control together, need Dry contact on and start ODU with wired controller; E27 mode need same with Dry contact setting, or will standby, but no error;
CN 20	Cooling signal switch	When there is cooling demand, the dry contact is ON, otherwise is OFF(signal is from user controller)	Dry contact signal, no voltage	If CN21 and CN20 all on, ODU operate mode is same with wired controller.
CN 17	Water replenishing switch	Reserved	ON-OFF signal, no voltage	Reserved

Note: CN47 doesn't work if ATW-A01 box is used/connected

Signal output in ATW-A01

NO.	Input Description	Remarks	Characteristic	
CN 18	OUT 1			reserved
CN 16	Defrost	ON: defrost OFF: not defrost	Dry contact signal, no voltage	Connect with fan coil, when ODU in defrosting, ODU will tell fan coil to stop operate
CN 14	Mode	ON: Cooling OFF: heating	Dry contact signal, no voltage. CN14 means cooling and heating through on/off; CN15 means cooling and heating status through on/off, which needs to be used with CN14. For example, CN14 is ON and CN15 is OFF means that the unit is standby in cooling mode (reaching the set temperature, etc.). CN14 OFF and CN15 ON means that the unit is operation in heating mode.	Connect with fan coil, CN14 and CN15 will output different signal according to ODU operate mode, so fan coil can adjust itself 's ON or OFF
CN 15	ON/OFF			
CN 13	ALARM	When the outdoor alarmed, output on dry contact	Dry contact signal, no voltage	Connect with fan coil/ floor heating dry
CN 12	3-valve 2	When the control line 1 is power on, the water to floor heating. Otherwise the water to Fan coil	3-way valve control line, 220V. In heating: 1# terminal ON 220V, 2#3# terminal ON 220V, otherwise 1# terminal OFF, 2#3# terminal ON 220V	IO board control, different mode will give power to different point, BM2-1OFF (Air condition mode) 3-valve 2 will open. BM2-1ON (Hot water mode) 3-valve 1 will open
CN 11	3-valve 1	When the control line 4 is power on, the water to DHW, otherwise the water to buffer tank	3-way valve control line, 220V, When the domestic hot water is running, 4# terminal ON 220V, 2#3# terminal ON 220V, otherwise 4# terminal OFF, 2#3# terminal ON 220V	
CN 10	DHW pump		220V	
CN 9	heater	DHW water tank heater	220V	Connect to 5 and 6 of relay, so give power to CN1- heater
CN 7	BSV4	Reserved	Reserved	
CN 5	BSV3	Reserved	220V	

NO.	Input Description	Remarks	Characteristic	
CN 4	BSV2 Auxiliary heat source signal	On/off dry contact	Dry contact signal, 220V. In heating mode, when the units is turned on more than 1 hour, the water temperature rises rate is below 0.1 °C/min and lower than the setting water temperature 3 °C, it will output 220V signal, This auxiliary heat can be electric heating or gas furnace.	
CN 3	BSV2	to cut off the water to floating	220V	heating mode open
	Floor heating valve			
CN 2	Air conditioner pump		220V	
CN 1	heater power	DHW water tank heater	220V	

1. If the ATW-A01 is not connected, the cooling and heating demand is from the controller YR-E27, YR-E27 is on, and the unit is on.

2. If the ATW-A01 is connected, when the cooling is required, turn on YR-E27 in the cooling mode, if ATW-A01 receives the on signal of cooling dry contact, the unit will start cooling; if ATW-A01 receives the off signal of cooling dry contact, the unit will turn off. Similarly, when heating is required, turn on YR-E27 in the heating mode, when the ATW-A01 receives the on signal of the heating dry contact, the unit will start heating; if ATW-A01 receives the off signal of heating dry contact, the unit will turn off.

23.7 Part discription

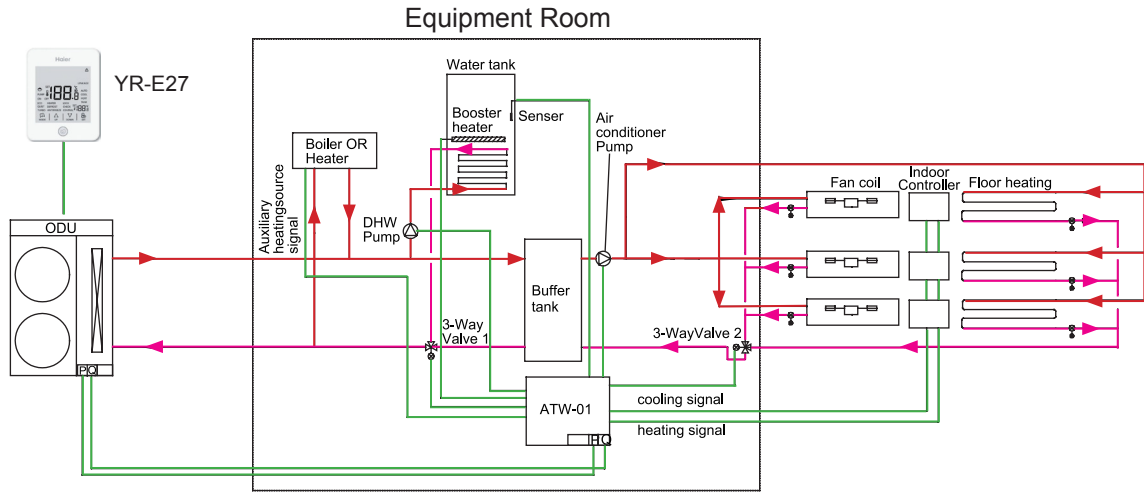

Fig.1 DHW (domestic hot water) controlled by YR-E27

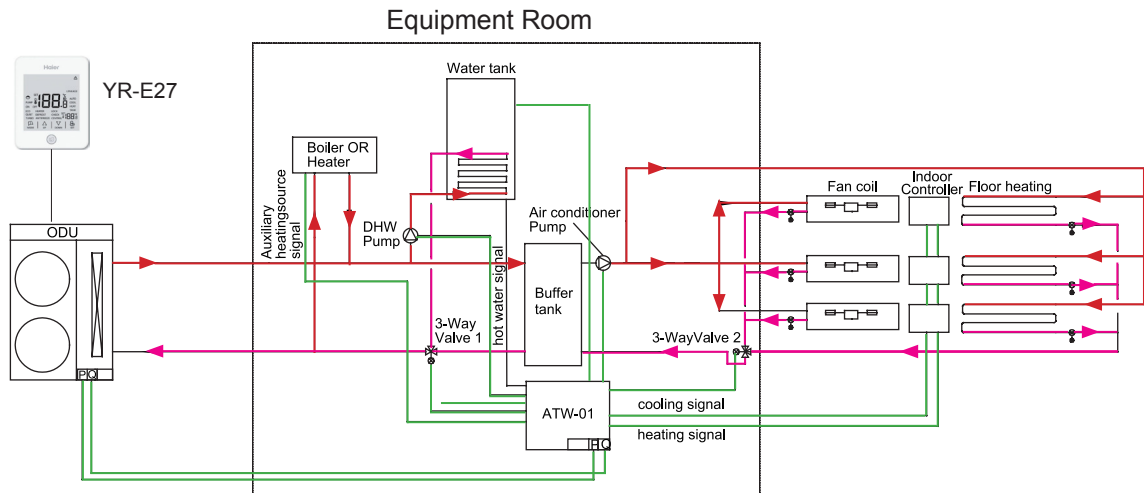

Fig.2 DHW (domestic hot water) controlled by user's controller

- Water supply pipe
- Water return pipe
- Signal wire

Parts description:

Outdoor unit pump: When both the client and E27 have demand signals, the water pump is turned on.

Air conditioning pump(connection with ATW-A01 15&16): this is a booster pump. When the lift of the pump supplied by the outdoor unit is not enough, the outdoor gives a signal to ATW-01 and the air conditioning pump opens. (Indoor and outdoor demand signal synchronization === = this is the premise of operation). If there is no IO board, and both client and E27 have demand signals and they are synchronized, the signal is sent to the air conditioning pump through E27, and the pump is turned on (the same as the outdoor unit pump is opened and closed). In hot water demand (tank mode), the air conditioning pump does not open.

DHW Pump:

When there is E27 controller and sensor in tank mode, terminals 5 & 6 of IO board receive the output signal demand, and the DHW Pump is turned on. When the sensor detects that the temperature in the hot water tank is the same as the set temperature of E27, the DHW Pump is turned off. When the user controls the hot water, the IO board receives the customer's hot water demand and sends the signal to the DHW Pump, which turns on. When the sensor of the water tank detects that the water temperature in the water tank is the same as the user's set temperature, the water tank temperature sensor gives a signal to the IO board, and the DHW Pump is turned off.

3-way valve 1 - 3-way valve 2 :

When 3-way valve 1 and 3-way valve 2 receive the IO board hot water tank signal, the hot water enters the hot water tank through 3-way valve 1, and finally returns to the outdoor unit through 3-way valve 1.

When 3-way valve 1 and 3-way valve 2 receive the IO board signal heating + tank, the hot water enters the floor heating through 3-way valve 2.

When 3-way valve 1 and 3-way valve 2 receive the IO board signal cooling + tank , the hot water enters the fan coil through 3-way valve 2.

Explanation of different modes on the YR-E27:

Cooling mode: only the cooling mode of fan coil, no hot water generation.

Heating mode: only floor heating mode, hot water is generated, hot water into the floor heating.

Tank + cooling mode: when there is a demand for water heater in summer, in tank + cooling mode, heating is carried out first. After the water storage of the water heater is full, the outdoor unit will switch to cooling mode, and the fan coil will operate.

Tank + heating mode: in winter, there is still demand for water heater. In the tank + heating mode, heating is carried out first. After the water storage of the water heater is full, the outdoor unit continues to be in heat mode and floor heating is running

Tank mode: hot water enters the hot water tank and returns to the outdoor unit through 3-way valve 1

Q&A:

In tank mode, it is controlled by CN22 on ATW-01. if there is DHW request, is the default value of outlet set at 55 °C? Is it possible to modify it? --- in tank mode, DHW signal is given, and the default value of outlet temperature is set at 55 °C. It can be changed by E27 controller

23.8 Safety

- If the connection kit is transferred to a new user, this manual shall be transferred to the user, together with the conditioner.
- Before installation, be sure to read Safety Considerations in this manual for proper installation.
- The safety considerations stated below is divided into “⚠Warning” and “⚠Attention”. The matters on severe accidents caused from wrong installation, which is likely to lead to death or serious injury, are listed in “⚠Warning”. However, the matters listed in “⚠Attention” are also likely causing the severe accidents. In general, both of them are the important items related to the security, which should be strictly abided by.
- After the installation, perform test run to make sure everything is in normal conditions, and then operate and maintain the connection kit in accordance with the user manual. The user manual should be delivered to the user for proper keeping.

⚠Warning

- Please ask the special maintenance station for installation and repair. Water leakage, electric shocks or fire accidents might be caused from improper installation if you conduct the installation by your own.
- The installation should be conducted properly according to this manual. Water leakage, electric shocks or fire accidents might be caused from improper installation.
- Please make sure to install the connection kit on the place where can bear the weight of the connection kit. The connection kit can't be installed on the grids such as the non-special metal burglar-proof net. The place with insufficient support strength might cause the dropdown of the machine, which may lead to personal injuries.
- The installation should be ensured against typhoons and earthquakes, etc. The installation uncomformable to the requirements will lead to accidents due to the turnover of the machine.
- Specific cables should be used for reliable connections of the wirings. Please fix the terminal connections reliably to avoid the outside force applied on the cables from being impressed on the cables. Improper connections and fixings might lead to such accidents as heating or fire accidents.
- Correct shapes of wirings should be kept while the embossed shape is not allowed. The wirings should be reliably connected to avoid the cover and the plate of the electrical cabinet clipping the wiring. Improper installation might cause such accidents as heating or fire accidents.
- While placing or reinstalling the connection kit, except the specific refrigerant (R410A), don't let the air go into the refrigeration cycle system. The air in the refrigeration cycle system might lead to the cracking or personal injuries due to abnormal high pressure of the refrigeration cycle system.
- During installation, please use the accompanied spare parts or specific parts. If not, water leakage, electric shocks, fire accidents or refrigerant leakage might be caused.
- During installation, if refrigerant leakage occurs, ventilation measures should be taken, for the refrigerant gas might generate harmful gases upon contacting the flame.
- After installation, check if any refrigerant leakage exists. If the refrigerant gas leaks in the room, such things as air blowing heaters and stoves, etc. may generate harmful gases.
- Don't install the connection kit at the places where the flammable gases may leak. In case the gas leakage occurs around the machine, such accidents as fire disasters may be caused.
- The refrigerant gas pipe, HP gas pipe and liquid pipe should be heat insulated to preserve heat. For inappropriate heat insulation, the water caused from the condensation will drop to get the article at home wet.
- The electrical construction shall be implemented by the correspondingly qualified personnel in accordance with electrical construction standards, local electrical laws as well as specifications. Moreover, dedicated circuit must be used, rather than the wire pin. Insufficient capacity of the wire circuit and unprepared construction (if any) may cause electric shock, fires, etc.
- During the process of grounding, the ground wire cannot be connected to the gas pipe, water pipe, lightning rod or ground wire of the telephone. Incomplete grounding may cause electric shock, fires, etc.
- Install residual-current circuit breaker, or electric shock, fires, etc. will occur.
- When contacting electrical components, ensure they are powered off. Contacting the live part may result in the danger of electric shock.

- If there is leakage of the refrigerant gas flow during operation, refrigerant gas is required. If the refrigerant gas contacts any fire, poisonous gases will be produced.
- If the supply cord is damaged, it must be replaced by the manufacturer, its service agent or similarly qualified persons in order to avoid a hazard.
- This appliance is not intended for use by persons (including children) with reduced physical, sensory or mental capabilities, or lack of experience and knowledge, unless they have been given supervision or instruction concerning use of the appliance by a person responsible for their safety.
- Children should be supervised to ensure that they do not play with the appliance.
- This appliance can be used by children aged from 8 years and above and persons with reduced physical, sensory or mental capabilities or lack of experience and knowledge if they have been given supervision or instruction concerning use of the appliance in a safe way and understand the hazards involved. Children shall not play with the appliance. Cleaning and user maintenance shall not be made by children without supervision.
- The appliances are not intended to be operated by means of an external timer or separate remote-control system.
- Keep the appliance and its cord out of reach of children less than 8 years.

⚠ Attention

- The connection kit should be effectively grounded. Electric shocks may occur if the connection kit is ungrounded or inappropriately grounded. The wire for earthing shouldn't be connected to the connections on the gas pipe, water pipe, lightning rod or telephone.
- The breaker for electricity leakage should be mounted. If not, accidents such as electric shocks may happen.
- The installed connection kit should be checked for electricity leakage by being powered.
- After installation, all cassette concealed connection kits should be trial-tested. After the proper operation of the machine, other fitments can be made.
- When installing the connection kit, please fix the box and connecting pipes in an efficient way to avoid shaking when changing connection kit.
- If the ambient humidity is over 80%, when the water discharge hole is blocked or the filter becomes dirty, or airflow speed change, there may be leads to condensing water drop down, and at the same time there may be some drops of water spit out.
- Keep the connection kit, power supply wiring, conductor, etc. at least 1 m away from the TV and radio to avoid image interference and noise. However, sometimes there is still noise when the distance is over 1 m due to the different states of radio waves.
- Try to install connection kit where the fluorescent lamp is far away.
- When wireless devices are being installed, the distance that the signal from the controller will reach may be shortened in a room with a fluorescent lamp that is turned on in an electric way (frequency conversion or rapid start).

⊘ Prohibitions

- Do not use components other than the fuse of proper capacity, such as metal wire and copper wire, which will cause fires and other faults if used instead of the fuse.
- When doing the cleaning and maintenance, make sure that the operation has been stopped and the manual power switch is in the off position.
- Do not use appliances such as water heater near the connection kit. Using appliances producing steam near the connection kit may lead to accidents such as water leakage, electric leakage and short circuit when the cooling system is in operation.

23.9 Installation procedure

Do not install at such places

1. A place that is filled with mineral oil, a kitchen which has oil and steam everywhere, etc., which may cause degradation, falling off and water leakage of the resinous components.
2. A place with corrosive gases such as sulphurous acid gas, which will lead to the corrosion of the copper tube, welding joint, etc., causing refrigerant leakage.
3. A place where machines give out electromagnetic waves, which will lead to abnormality and improper function of the control system.
4. A place with possible leakage of combustible gases, floating of carbon fiber and combustible dust and use of volatile combustible substances such as diluents, the accumulation of which around the machine set will lead to fires.
5. A place where small animals inhabit, whose contacting the inner electrical components may cause faults, smoking, outbreak of a fire, etc.
6. A coastal place with high salinity and a place with great variation in voltage such as a factory, which may cause faults to vehicles and ships.

Mounting dimension

Mounting dimensions are shown in the Fig.3.

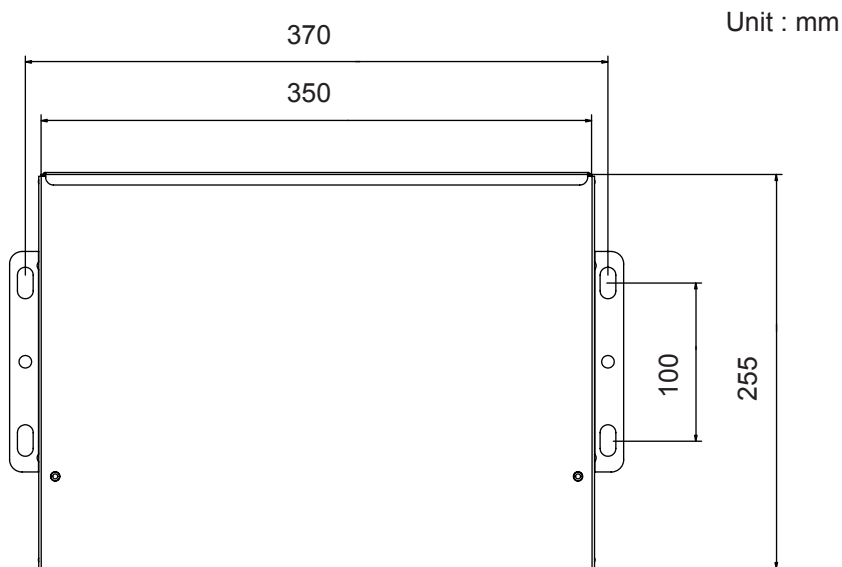

Fig.3

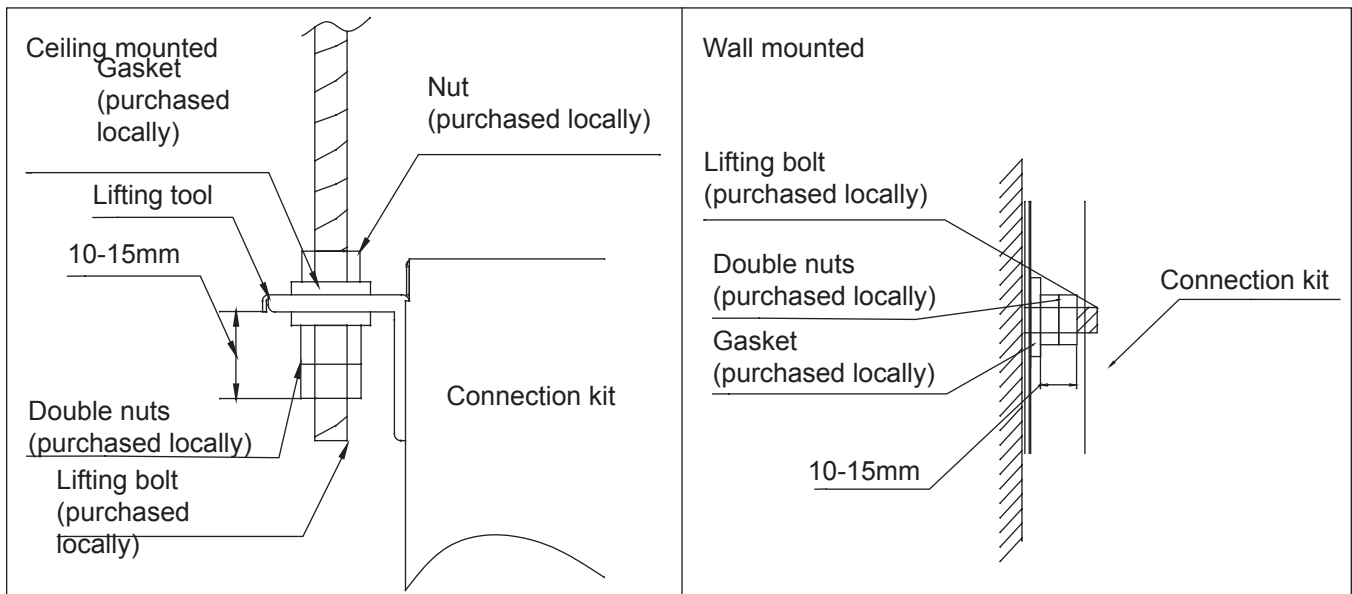

Fig.4

Install the lifting tools on the lifting bolts according to the instruction of the Fig.4.

Be sure to follow the stipulations on products locally purchased to use nuts (M8 or M10 of 3 pieces for 4 positions) and gaskets (M8 with the outer diameter of 24~28 mm and M10 with that of 30~34 mm of 2 pieces for 4 positions) on the upper and lower sides of the lifting tools.

<Note>

Be sure that the product must be installed with the top surface (the oblique surface in the Fig.4) upward, or it will not work well and increase the working noise.

23.10 Procedure Electrical wiring

⚠ Warning

- Electrical construction should be made with specific mains circuit by the qualified personnel according to the installation instruction. Electric shock and fire may be caused if the capacity of power supply is not sufficient.
- During arranging the wiring layout, specified cables should be used as the mains line, which accords with the local regulations on wiring. Connecting and fastening should be performed reliably to avoid the external force of cables from transmitting to the terminals. Improper connection or fastness may lead to burning or fire accidents.
- There must be the ground connection according to the criterion. Unreliable grounding may cause electrical shocks. Do not connect the grounding line to the gas pipe, water pipe, lightning rod and telephone line.

⚠ Attention

- Only copper wire can be used. Breaker for electric leakage should be provided, or electric shock may occur.
- The wiring of the mains line is of Y type. The power plug L should be connected to the live wire and plug N connected to null wire while \ominus should be connected to the ground wire. For the type with auxiliary electrically heating function, the live wire and the null wire should not be misconnected, or the surface of electrical heating body will be electrified. If the power line is damaged, replace it by the professional personnel of the manufacturer or service center.

- The power line of connection kits should be arranged according to the installation instruction of connection kits.
- The electrical wiring should be out of contact with the high-temperature sections of tubing as to avoid melting the insulating layer of cables, which may cause accidents.
- After connected to the terminal tier, the tubing should be curved into be a U-type elbow and fastened with the pressing clip.
- Controller wiring and refrigerant tubing can be arranged and fixed together.
- The machine can't be powered on before electrical operation. Maintenance should be done while the power is shut down.
- Seal the thread hole with heat insulating materials to avoid condensation.
- Signal line and power line are separately independent, which can't share one line. [Note: the power line, signal line are provided by users. Parameters for power lines are shown as below: $3 \times (1.0-1.5) \text{ mm}^2$; parameters for signal line: $2 \times (0.75-1.25) \text{ mm}^2$ (shielded line)]
- Connection kits and outdoor units should be connected to the power source separately. All connection kits must share one single electrical source, but its capacity and specifications should be calculated. Indoor & outdoor units should be equipped with the power leakage breaker and the overflow breaker.
- Connection kit can be installed in multiple, named as unit A, unit B.... Pay attention to the marks on the terminal block when connecting the outdoor unit with the indoor unit. Refer to wiring example as described in 5-2 while ensuring correct connection. In addition, the operation will be abnormal when the wiring and the tubing between indoor and outdoor machine sets are installed in different refrigerant systems.
- Energization is not to be done before it's confirmed that the connection kit have completely installed and that the outdoor and indoor installation is completed.

The wiring for the power line and signal line of connection kit

The wiring for the power line of connection kit, the wiring for the signal line between connection kits and outdoor units as well as the wiring between connection kits.

Total Current of valve boxes (A)	Items	Cross Section (mm^2)	Length (m)	Rated Current of Overflow Breaker (A)	Rated Current of Power Leakage Breaker (A) Leaking Current (mA) Operating Period (S)	Cross Sectional Area of Signal Line	
						Outdoor - connection kit (mm^2)	Connection kit - connection kit (mm^2)
<10		2	20	20	20A,30mA,0.1S or below	2cores \times 0.75-2.0 mm^2 shielded line	
≥ 10 and <15		3.5	25	30	30A,30mA, 0.1S or below		
≥ 15 and <22		5.5	30	40	40A,30mA, 0.1S or below		
≥ 22 and <27		10	40	50	50A,30mA, 0.1S or below		

- Power cable and communication wire must be fixed firmly.
- Each connection kit must be earthed well.
- When power cable exceeds the range, thicken it appropriately.
- Shielded layer of communication wires must be connected together and be earthed at single point.
- Communication wire total length cannot exceed 500m.

Notes:

- (1) The above wiring example is only for reference. The number of connection kits and indoor units shall be subject to the field installation.
- (2) Two-core non-polar communication line with shield shall be adopted for communication lines between the connection kit and the indoor/outdoor unit.
- (3) All connection kits within one system may share one over current breaker for power supply. But it's necessary to compute total current capacity specification.
- (4) For wiring harness connected to the power terminal block, the terminal shall be pressed with a round (refer to the following figure).

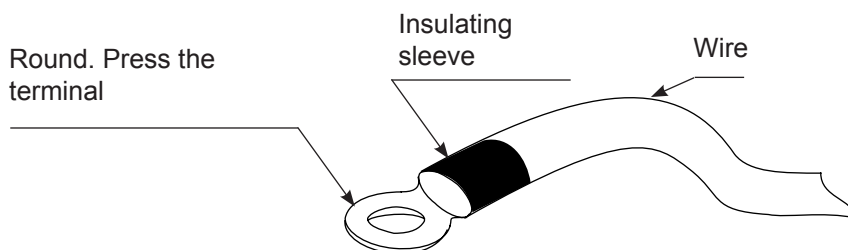

- 1) The power terminal block shall not be crimped with 2 wires of different diameters. Otherwise, poor crimp connection and looseness may lead to abnormal heating or sparking of the line.
- 2) Refer to the following figure for crimping wires with the same diameter.

Connect wires with the same diameter on both sides

It's forbidden to connect two wires on one side

Wires with different diameters are not allowed

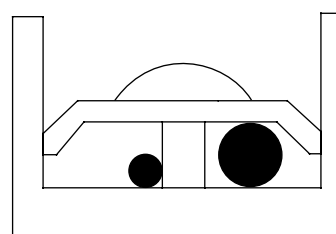
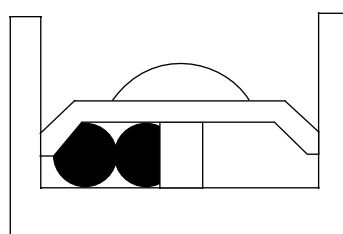
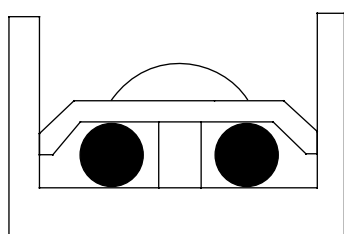

- (5) Tighten terminal screws with proper screw driver. Screw driver of small dimension will damage the screw head and fail to tighten properly.
- (6) If terminal screws are tightened excessively, they may be damaged. Refer to the following table for tightening torques of terminal screws:

Dimension of terminal screw	Tightening torque (N.m)
M3.5 (terminal block for communication line)	0.80~0.96
M4 (terminal block for power line)	1.18~1.44
M4 (terminal block for ground wire)	1.52~1.86

- (7) Power line is forbidden to the communication terminal block because it will damage the circuit control board.
- (8) Wiring of communication lines shall be within the following scope. Exceeding the limit will possibly lead to abnormal communication.
 - 1) The maximum wiring length between the outdoor machine and the valve cage, the valve cage and the indoor machine, and between valve cages is 1000 m at most. The total wiring length is 1000m at most.
 - 2) The maximum wiring length between the valve cage and the wire controller for switching working modes is 500 m at most.

23.11 Move and scrap the air conditioning

- When moving, to disassemble and re-install the air conditioning, please contact your dealer for technical support.
- In the composition material of air conditioning, the content of lead, mercury, hexavalent chromium, polybrominated biphenyls and polybrominated diphenyl ethers are not more than 0.1% (mass fraction) and cadmium is not more than 0.01% (mass fraction).
- Please recycle the refrigerant before scrapping, moving, setting and repairing the air conditioning; for the air conditioning scrapping, should be dealt with by the qualified enterprises.

24. Appendix

24.1 Connection heater

For AU052FYCRA(HW) and AU082~162FYCRA(HW), the position where the heater is connected is different.

AU052FYCRA(HW) is connected on the PCB, and AU08 ~ 162FYCRA(HW) is connected on ATW-A01

AU052FYCRA(HW) Auxiliary electric heating on outdoor unit (terminal CN58)

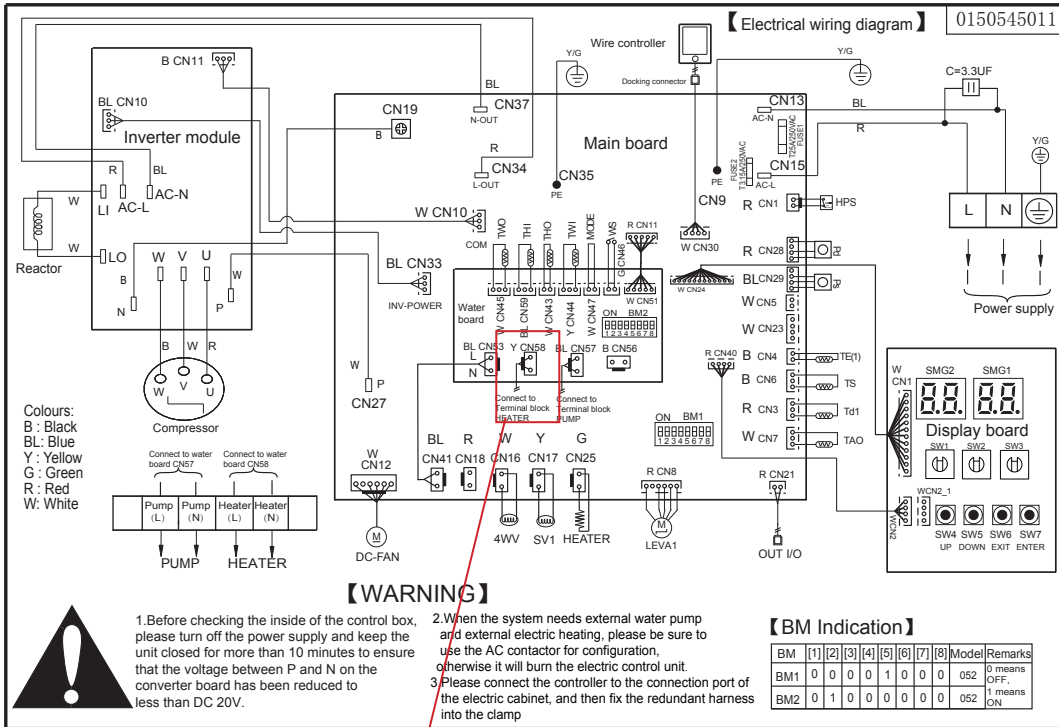

Port	Logic
CN58	<p>ON: Meet all the conditions as below:</p> <ol style="list-style-type: none"> Run in heating mode: Outdoor unit therrmon on running for more than 1h. $T_{set} - T_{wo} > 3$ & $T_{wo}(n) - T_{wo}(n-1) < 0.1^{\circ}\text{C}$ (n, current water temp, n-1,1 min before water temp.) Outdoor ambient temp $< 0^{\circ}\text{C}$ <p>OFF: meet any condition as below</p> <ol style="list-style-type: none"> Not run in heating mode: $T_{set} - T_{wo} \leq 1^{\circ}\text{C}$ Outdoor ambient temp $> 2^{\circ}\text{C}$

AU08 ~ 162FYCRA(HW) Auxiliary electric heating on outdoor unit(terminal CN4 11&12)

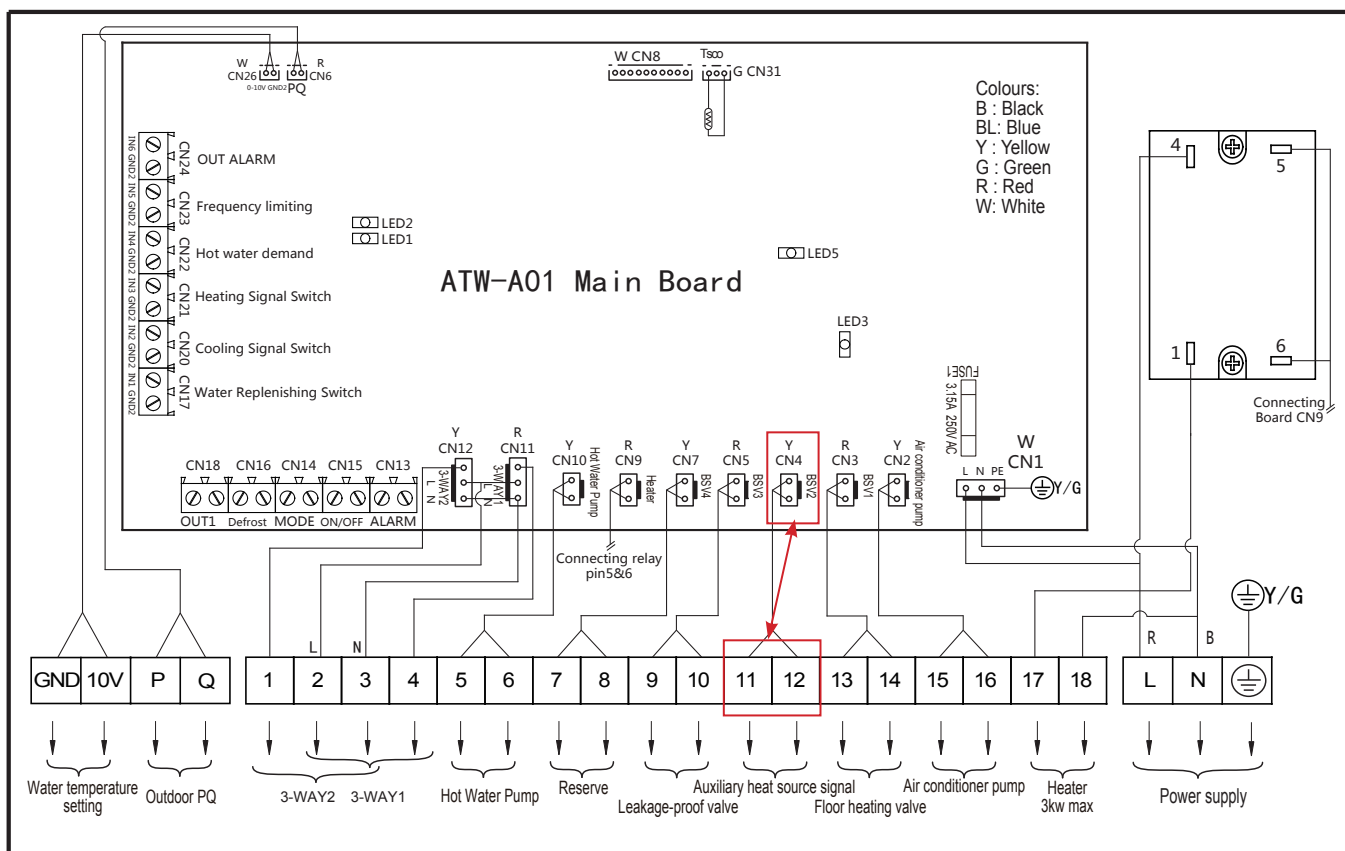

Port	Logic	
CN4	In heating mode . ON: Unit is turned on >1h, the water temp. rises rate < 0.1°C /min & Two < Tset -3°C OFF: Tset-Two<=1 °C	AC 220V signal . Port 11 & 12 Heat source: Solar or natural gas-assisted heat sources Note: If need to connect electric heater, must connect relay!

Haier Commercial Air Condition

ADDRESS: No.1 Haier Road, Hi-tech Zone, Qingdao 266101 P.R.China

Web: [Http://www.haier.com](http://www.haier.com)

Haier reserves the right to make change without any notice.