

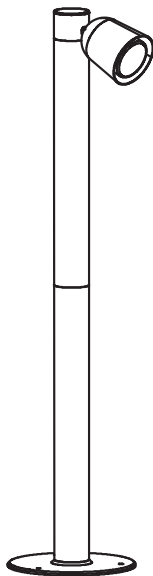

Philly

EAN CODE : 3276007464139



2/2



2022/07-V01

FR Manuel d'Instructions

EL Εγχειρίδιο Οδηγιών

DE Anleitung Handbuch

ES Manual de Instrucciones

PL Instrukcja Obsługi

EN Instructions Manual

PT Manual de Instruções

UA Інструкція з Експлуатації

IT Manuale di Istruzioni

RO Manual de Instrucțiuni

*Année de garantie / años de garantía / Ano de garantia / Anno di garanzia / Έτος εγγύησης / Rok gwarancji / Гарантіяроків / Anul de garanție / Jahr der Garantie / Year of guarantee

** réparable / reparabile / reparável / riparabile / διορθώσιμος / naprawiany / ремонтний / reparabil / reparaturfähig / repairable



FR:Montage / ES:Montaje / PT:Montagem / IT:Montaggio / EL:Συναρμολόγηση / PL:Montaż /
UA:Збірка / RO:Montaj / DE:Montage / EN:Assembly



4 → 8

FR : CARACTERISTIQUES TECHNIQUES / ES : CARACTERÍSTICAS TÉCNICAS / PT : CARACTERÍSTICAS TÉCNICAS /
IT : CARATTERISTICHE TECNICHE / EL : ΤΕΧΝΙΚΑ ΧΑΡΑΚΤΗΡΙΣΤΙΚΑ / PL : DANE TECHNICZNE / UA : ΤΕΧΝΙЦИ
ΧΑΡΑΚΤΕΡΙΚΙ / RO : CARACTERISTI TECHICE / DE : TECHNISCHE MERKMALE / EN : TECHNICAL CHARACTERISTICS



1 / 2



1

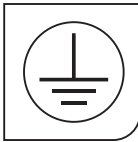

2

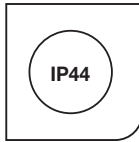

6

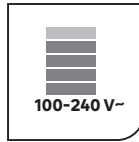

7

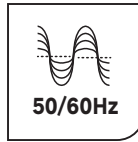

8

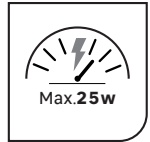

9



12

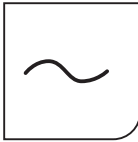

30



36

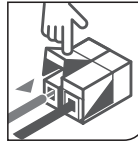

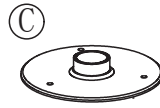
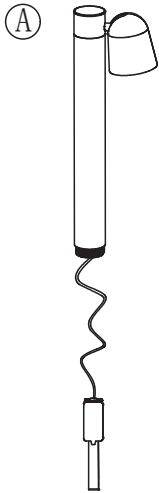

0 1 2 3 4 5 cm

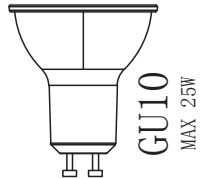
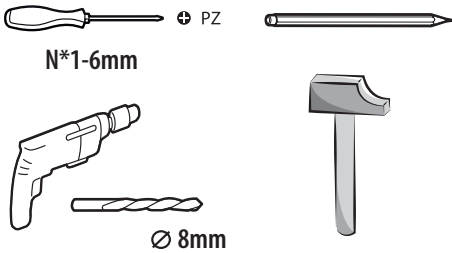
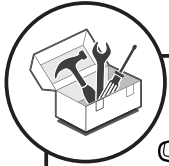
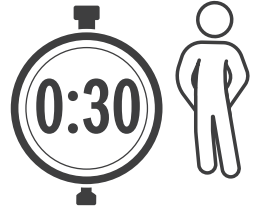
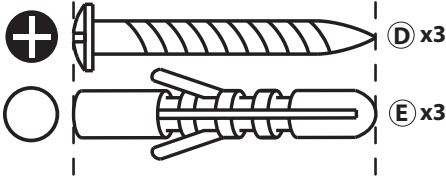

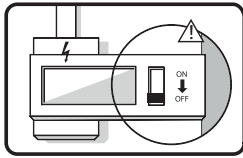

1

1

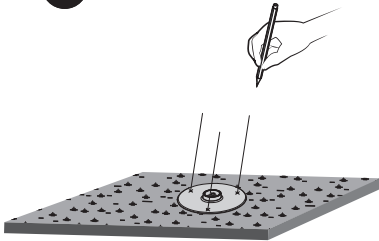

2

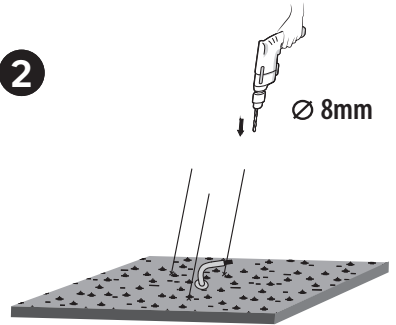

3

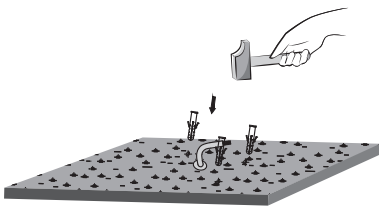

4

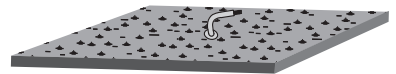

2

5

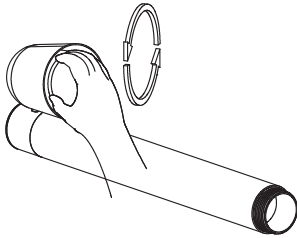

6

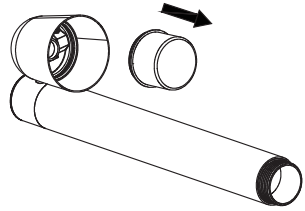

7

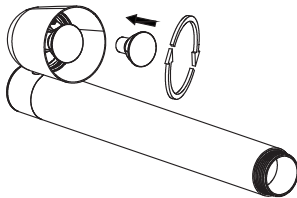

8

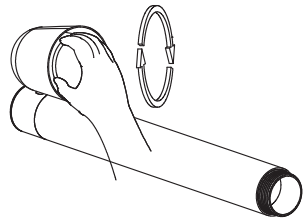

3 9

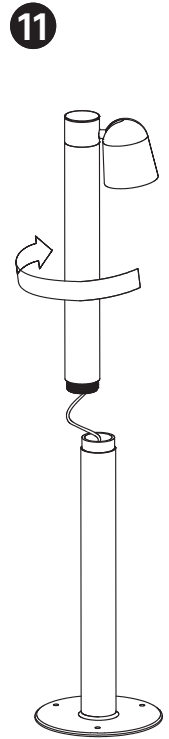
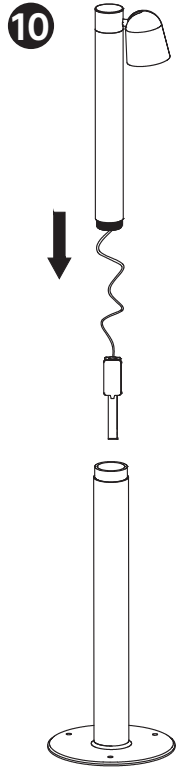
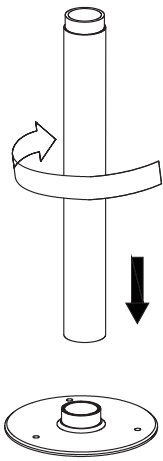

4

12

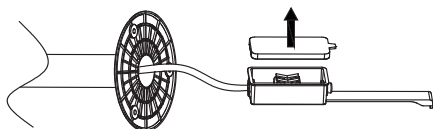

13

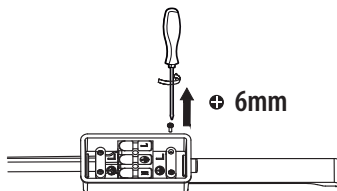

14

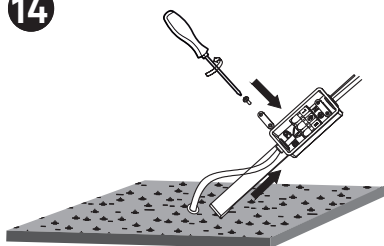

15

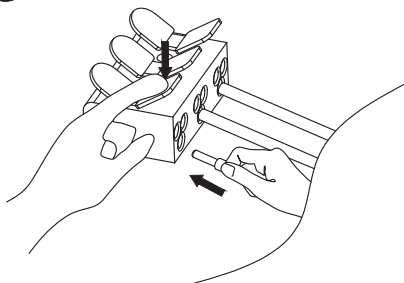

16

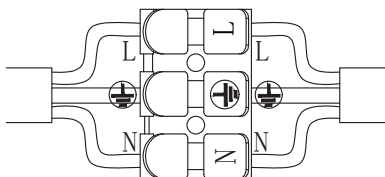

17

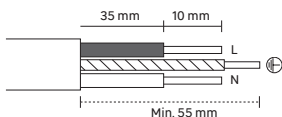
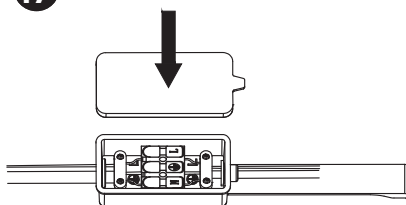

N = Bleu/Azul/Azu/Blu/Μπλε/Niebieski/Синій/Albastru/Blau/Blue

⊕ ⊖ = Vert et jaune/Verde y amarillo/Verde e amarelo/Verde e giallo/Πράσινο και κίτρινο / Zielony i żółty / Зелений і жовтий/Verde-galben/Grün und gelb/Green and yellow

L = Marron/Marrón/Castanho/Marrone/Καφέ/Brazowy/Коричневий/Μαρο/Braun/Brown

5

18

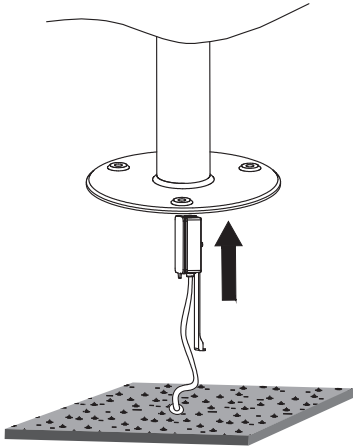

19

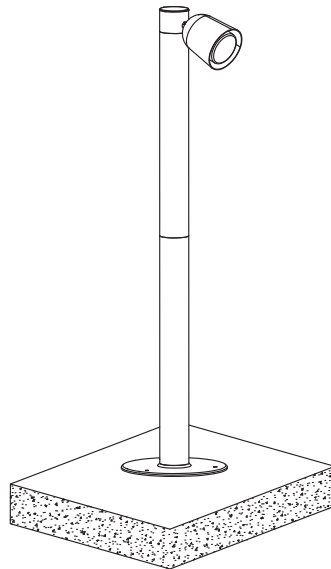
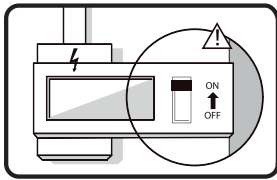
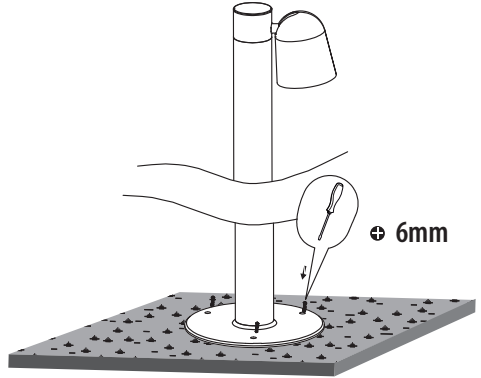



Ce produit se recycle,
s'il n'est plus utilisable
déposez-le en déchèterie.

Notice à trier.

Pour en savoir plus :
www.quefairedemesdechets.fr

- FR** Ce produit est recyclable. S'il ne peut plus être utilisé, veuillez l'apporter dans un centre de recyclage de déchets.
- ES** Este producto es reciclable. Si ya no se puede usar, llévalo a un centro de reciclaje de residuos.
- PT** Este produto é reciclável. Se deixar de o utilizar, entregue-o num centro de reciclagem de resíduos.
- IT** Questo prodotto può essere riciclato. Se deve essere smaltito, portalo presso un centro di riciclaggio.
- EL** Αυτό το προϊόν είναι ανακυκλώσιμο. Εάν δεν μπορεί πλέον να χρησιμοποιηθεί, μεταφέρετε την σε κάποιο κέντρο ανακύκλωσης απορριμμάτων.
- PL** Ten produkt poddawany jest recyklingowi, kiedy przestaje być użyteczny należy dostarczyć go do punktu zbiórki odpadów.
- UA** Цей продукт може перероблятися. Якщо воно більше не є придатне для використання, здайте його в утилізаційний центр.
- RO** Acest produs este reciclabil. Dacă nu mai poate fi folosit, vă rugăm să îl aduceți într-un centru de reciclare a deșeurilor.
- DE** Dieses Produkt ist recycelbar. Wenn es nicht mehr verwendet werden kann, bringen Sie es bitte zum Wertstoffhof
- EN** This product is recyclable. If it cannot be used anymore, please take it to waste recycling centre.



Traduction de la version originale du mode d'emploi / Traducción de las Instrucciones originales / Tradução das Instruções Originais / Traduzione delle istruzioni originali / Μετάφραση των πρωτότυπων οδηγιών / Traducerea instrucțiilor originale / Originalanleitung / Original Instructions

ADEO Services - 135 Rue Sadi Carnot - CS 00001 - 59790 RONCHIN - France

UA Виробник: ТОВ "Адео Сервісез С.А.", вул. Саді Карно, CS 00001, 59790 Роншєн, Франція.
Імпортер: ТОВ "Лєруа Мерлен Україна", 04201 Україна, м.Київ, вул. Полярна 17А, +380 44 498 46 00.
Імпортер приймає претензії від споживачів щодо товару, а також проводить його еремент, технічне і гарантійне обслуговування

BR IMPORTADO E DISTRIBUÍDO POR:
LEROY MERLIN COMPANHIA BRASILEIRA
DE BRICOLAGEM CNPJ: 01.438.784/0001-05
Rua Pascoal Pais, nº. 525, 6º andar, cj 61 a 64 -
Vila Cordeiro, São Paulo - SP CEP: 04581-060
CALM (Central de Atendimento Leroy Merlin)
Capitais 4020-5376 Demais Regiões 0800-0205376
IMAGEM ILUSTRATIVA

ZA Imported by Adeo South Africa (PTY) LTD T/A Leroy Merlin/Leroy Merlin Greenstone Store/Corner Blackrock Street and Stoneridge Drive, Greenstone Park Ext 2, Edenvale, 1610 Johannesburg, Gauteng, South Africa

Made in China
Країнапоходження: Китай