

**PALES  
BLADES  
PALAS  
PALE  
FLÜGEL**

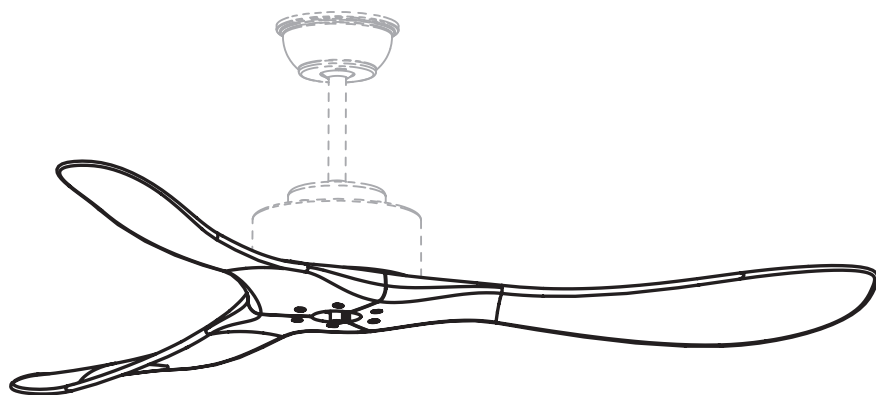

CONVIENT POUR / SUITABLE  
FOR / APTAS PARA / ADATTE  
PER / GEEIGNET FÜR :

**MODULO REGULAR V2  
MODULO SLIM  
TENERIFE**

**MANUEL D'UTILISATION (FR)  
USER MANUAL (EN)  
MANUAL DE INSTRUCCIONES (ES)  
MANUALE D'ISTRUZIONI (IT)  
ANLEITUNG (DE)**

# Sommaire / Table of contents / Índice / Indice / Inhaltsverzeichnis

<b>FRANÇAIS</b> .....	1
Contenu .....	1
Installation .....	1

<b>ENGLISH</b> .....	3
Packing .....	3
Installation .....	3

<b>ESPAÑOL</b> .....	5
Contenido .....	5
Instalación .....	5

<b>ITALIANO</b> .....	7
Contenuto .....	7
Installazione .....	7

<b>DEUTSCH</b> .....	9
Verpackung .....	9
Montage .....	9

Lisez ces instructions attentivement avant l'utilisation,  
et conservez-les pour de futures consultations.

USAGE DOMESTIQUE UNIQUEMENT

Lisez le manuel d'instructions fourni avec votre ventilateur de plafond.



**ATTENTION!** N'alimentez pas le ventilateur sans que les pales soient montées.

Le moteur est équipé d'une sécurité qui empêchera le moteur de fonctionner en marche normal.

## CONTENU

Compris dans ce pack:

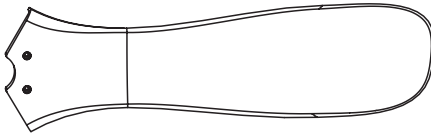

P3 pales (3 pcs)



Vis (7 pcs)

## INSTALLATION

A l'aide d'un tournevis enlevez les calles en caoutchouc se trouvant entre le carter et le moteur.

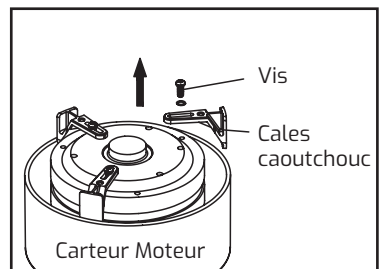

## Installation de 3 Pales:

Repérez les marques pour installer 3 pales sur la platine du moteur.

Placer les trois pales sans serrez les vis au maximum. Laisser la possibilité d'ajuster plus tard les pales.

Une fois les trois pales installées, faite l'ajustage de celles-ci de façon que l'espace entre les pales soit minimale. Serrez les fisses au maximum.

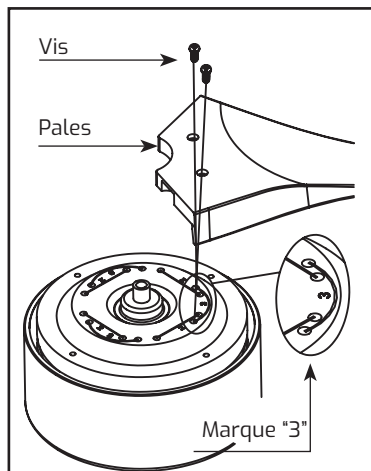

**ATTENTION!** Faites attention lors de l'assemblage des pièces, un seul élément non assemblé peut légèrement déséquilibrer le ventilateur. N'oubliez pas un seul élément, les vis, les rondelles.

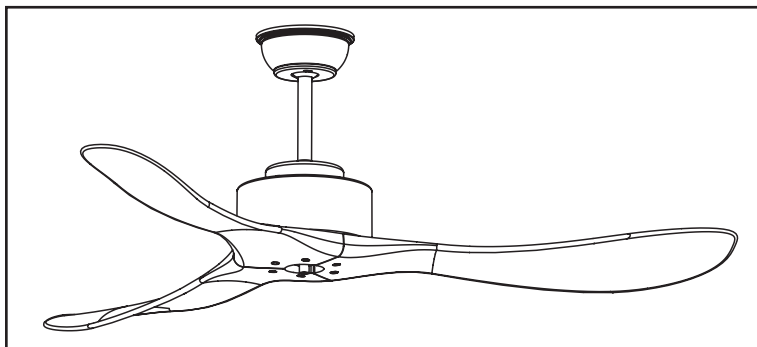

Please read this user manual carefully before use,  
and keep it for future reference.

HOUSEHOLD USE ONLY

Read the instruction manual included with your ceiling fan.



**ATTENTION!** Do not switch on the fan before the blades are mounted.

The engine is equipped with a safety feature that will prevent it from operating in normally.

## PACKING

This pack includes:

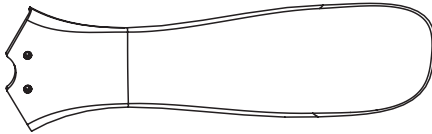

P3 blades (3 pcs)



Screws (7 pcs)

## INSTALLATION

Using a screwdriver, remove the rubber wedges between the motor housing and the engine.

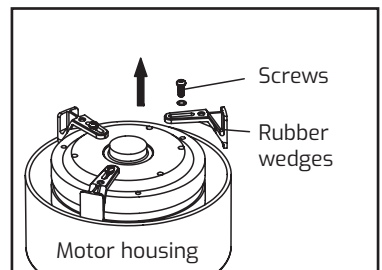

### Installation of 3 Blades:

Locate the marks to install 3 blades on the motor board.

Place the three blades without tightening them to the end at this point.

Once the three blades are installed, adjust them so that the space between the blades is minimal.

Now, tighten the screws to the maximum.

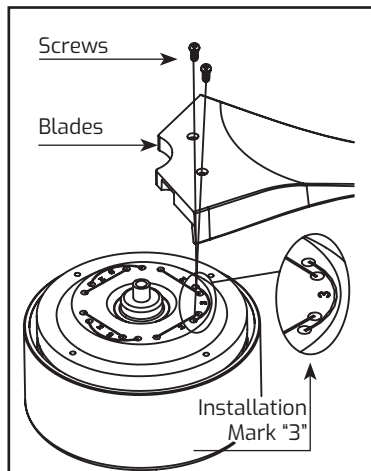

**ATTENTION!** Be careful when assembling the parts, only one unassembled item can slightly unbalance the fan. Please do not forget a single element, screws, washers.

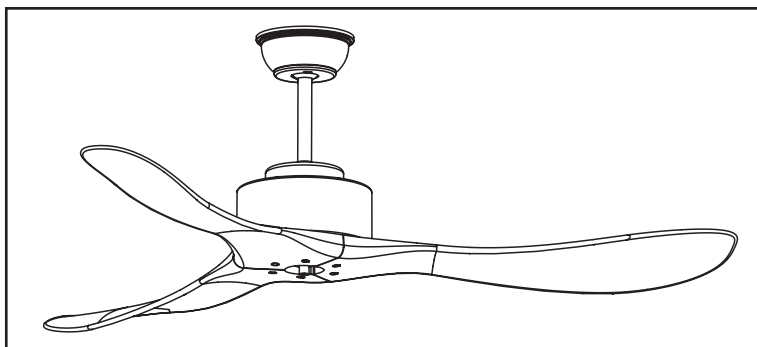

---

Plastic and cardboard packaging can be recycled. Separate and dispose of each material in the appropriate recycling container. Consult your local authorities for more information on recycling.

**ES**

**MODULO - P3 SERIES**

Lea estas instrucciones detenidamente antes del uso, y guárdelas para futuras consultas

SOLO PARA USO DOMÉSTICO

Lea el manual de instrucciones incluido con su ventilador de techo.



**¡ATENCIÓN!** NO poner en marcha el ventilador sin las aspas montadas.

El motor está equipado con una característica de seguridad que evitará que el motor funcione normalmente.

## CONTENIDO

Incluido en este pack:

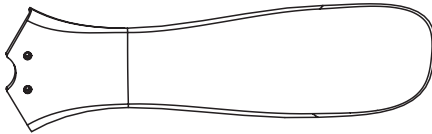

Palas P3 (3 pcs)



Tornillos (7 pcs)

## INSTALACIÓN

Con un destornillador, retire las cuñas de goma entre la carcasa y el motor.

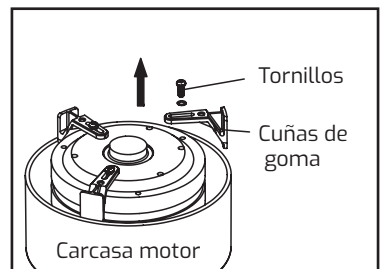

## Instalación de 3 aspas:

Localice las marcas para instalar 3 aspas en la placa del motor.

Coloque las tres aspas sin apretarlas del todo hasta el final en este punto.

Una vez instaladas las tres aspas, ajústelas de manera que el espacio entre las aspas sea mínimo.

Ahora, apriete los tornillos al máximo.

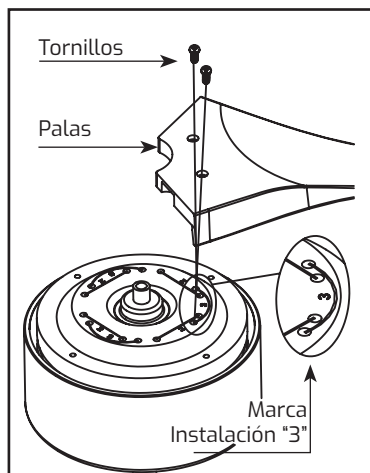

**¡ATENCIÓN!** Tenga cuidado al montar las piezas, un solo elemento sin colocar en su lugar correctamente puede desequilibrar ligeramente el ventilador. Por favor, no olvide un solo elemento, tornillos, arandelas.

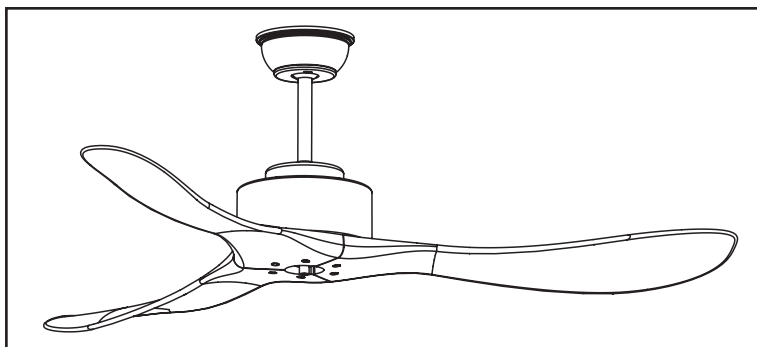

---

Los envases y embalajes de plástico y cartón se pueden reciclar. Separe y tire cada material en el contenedor de reciclaje adecuado. Consulte con sus autoridades locales para obtener más información sobre el reciclaje.



Leggere attentamente prima dell'uso e conservare queste istruzioni per ogni riferimento futuro.

SOLO PER USO DOMESTICO

Leggere il manuale d'istruzioni incluso nel vostro ventilatore da soffitto.

 **ATTENZIONE!** Non avviare il ventilatore senza le pale installate.

Il motore è dotato di una funzione di sicurezza che non consente al motore di funzionare normalmente.

## CONTENUTO

Incluso in questo pacchetto:

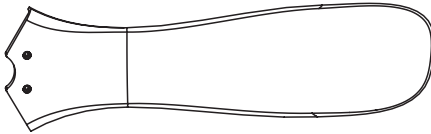

Pale P3 (3 pcs)



Viti (7 pcs)

## INSTALLAZIONE

Con un cacciavite, rimuovere i tasselli di gomma tra l'alloggiamento e il motore.

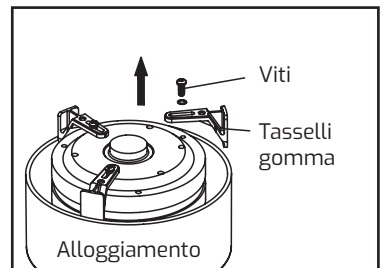

## Installazione di 3 pale:

Trovare i segni per installare 3 pale nella piastra del motore.

Inserire le 3 pale senza stringere fino in fondo.

Dopo aver installato le pale, aggiustarle in modo che lo spazio tra le pale sia minimo. Ora stringere le viti al massimo.

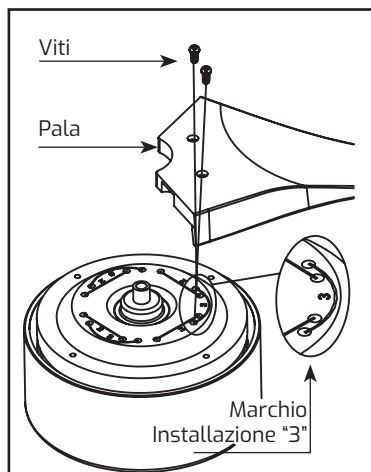

**ATTENZIONE!** Prestate attenzione quando assemblete le parti, un singolo elemento non correttamente posizionato può sbilanciare leggermente il ventilatore. Si prega di non dimenticare un singolo elemento, viti, rondelle.

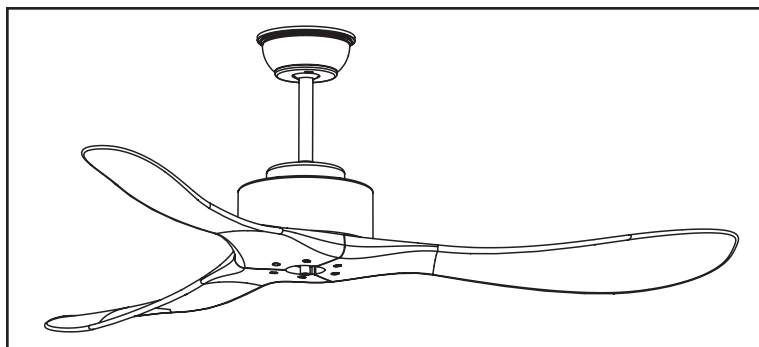

Gli imballaggi di plastica e cartone possono essere riciclati. Separare e smaltire ogni materiale nell'apposito contenitore per il riciclaggio. Consultare le autorità locali per ulteriori informazioni sul riciclaggio.

Lesen sie diese wichtigen anweisungen sorgfältig durch und bewahren sie sie gut auf.

NUR FÜR DEN HAUSGEBRAUCH

Lesen Sie die Ihrem Deckenventilator beiliegende Betriebsanleitung.



**ACHTUNG!** Den Ventilator ohne montierte Flügel nicht in Betrieb setzen.

Der Motor ist mit einem Sicherheitsmodus ausgestattet, der den normalen Betrieb des Motors verhindert.

## VERPACKUNG

Diese Verpackung beinhaltet:

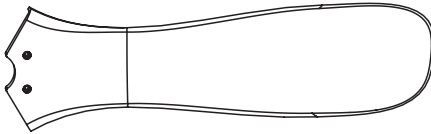

P3 Flügel (3 pcs)



Schrauben (7 pcs)

## MONTAGE

Entfernen Sie mit einem Schraubenzieher die Gummiunterscheiben zwischen dem Gehäuse und dem Motor.

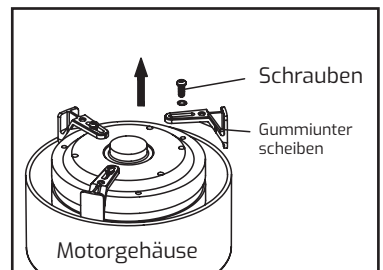

## Montage von 3 Flügeln:

Suchen Sie die Markierungen, um 3 Flügel auf dem Motor zu installieren.

Platzieren Sie die drei Flügel, ohne sie an diesem Punkt bis zum Ende festzuziehen.

Wenn die drei Flügel installiert sind, stellen Sie sie so ein, dass der Abstand zwischen den Flügeln minimal ist. Ziehen Sie nun die Schrauben bis zum Maximum an.

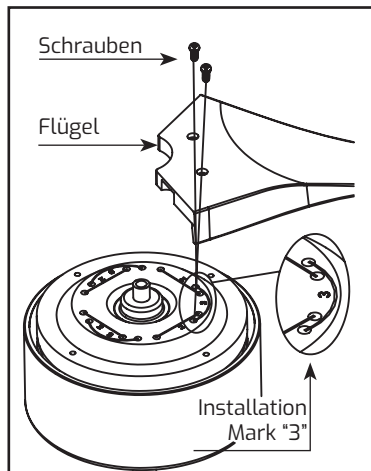

**ACHTUNG!** Seien Sie beim Zusammenbau der Teile vorsichtig, nur ein unmontiertes Teil kann den Ventilator leicht aus dem Gleichgewicht bringen. Bitte vergessen Sie nicht ein einzelnes Element, Schrauben, Scheiben

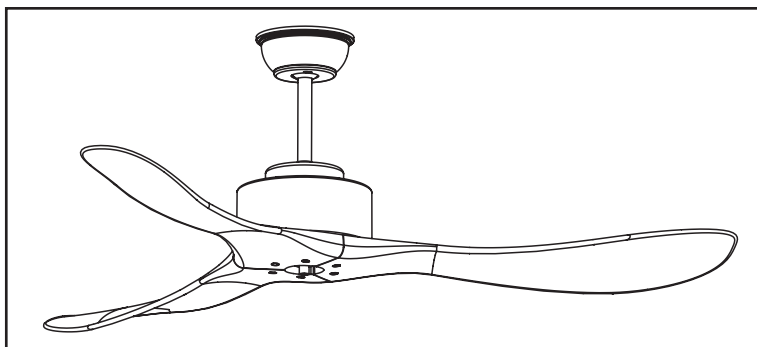

---

Kunststoff- und Kartonverpackungen können recycelt werden. Trennen Sie jedes Material und entsorgen Sie es in dem dafür vorgesehenen Recyclingbehälter. Weitere Informationen zum Recycling erhalten Sie bei Ihren örtlichen Behörden.









---

**IMPORTER / IMPORTADOR:**

**CLIMACITY S.L.**

C. Torrox 2 - 5, 28041 Madrid, Spain

[contact@klassfan.com](mailto:contact@klassfan.com)

[www.klassfan.com](http://www.klassfan.com)