

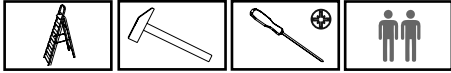

# K144

v.05



A x 16	B x 16	C x 20	D x 20	E x 20	F x 80	G x 94	H x 12	I x 08
						 3.5 x 15 mm.	 3.5 x 20 mm.	 4 x 27 mm.
J x 08	K x 06	L x 02	M x 04	N x 12	Ñ x 24	O x 24	P x 01	Q x 16
							 Nº 4	 15 mm.
R x 08	S x 02							
 7 mm.								



**ES**

### RECOMENDACIONES MONTAJE Y USO

Agrupe y cuente el herraje.  
Prepare todas las piezas para el montaje del mueble.  
Tenga preparadas las herramientas para el montaje.  
Prepare la zona del montaje.  
Monte el mueble sobre una moqueta para evitar rayar y dañar la superficie del mueble.  
No fuerce los ensamblajes.  
Evite colocar el mueble cerca de fuentes de calor.  
Evite utilizar trapos, paños o productos de limpieza que puedan dañar la superficie del mueble.  
Mueble para uso doméstico en interior de vivienda.

**EN**

### RECOMMENDATIONS FOR ASSEMBLY AND USE

Prepare all the parts of the furniture  
Group and count all the hardware  
Prepare all the tools for the assembly.  
Clear and prepare the assembly area.  
Do the assembly on a carpet to avoid damaging the surface of the furniture  
Avoid forcing the fittings  
Avoid placing the Furniture near any heating source  
Do not use cloths or cleaning products to avoid damaging the surface of the furniture  
Indoor furniture. Suitable for domestic use.

**FR**

### CONSEILS DE MONTAGE CONSEILS POUR L'USAGE

Préparez les différents parts du meuble  
Regroupez et comptez toute la quincaillerie  
Préparez l'outillage nécessaire  
Aménagez-vous une area de montage  
Faire le montage sur moquette afin de protéger le meuble des rayures  
Ne forcer pas le montage  
Évitez placer le meuble près des sources de chaleur  
Évitez utiliser de chiffons ou des produits de nettoyage pour ne pas rayer la superficie du meuble  
Meuble d'usage domestique pour l'intérieur de la maison.

**PT**

### RECOMENDAÇÕES PARA MONTAGEM E USO

Prepare todas as peças para a montagem de móveis  
Reagrupar e contar o hardware  
Preparar as ferramentas de montagem  
Preparar a área de montagem  
Montar as peças em tapete para evitar riscos e danos na superfície dos móveis  
Não force as assembleias  
Não colocar móveis perto de fontes de calor  
Evitar o uso de panos, trapos ou produtos de limpeza que possam riscar o móvel.  
Móveis para uso doméstico no interior da casa.

**IT**

### CONSIGLI INSTALLAZIONE ED USO

Preparare tutti componenti del mobile per il montaggio  
Ordinare la ferramenta  
Preparare tutti gli attrezzi necessari per il montaggio  
Preparare l'area di montaggio  
Fare il montaggio su un tappeto per evitare danneggiare le superfici dei mobili  
Non forzare i componenti  
Evitare posizionare il mobile in prossimità di fonti di calore  
Non usare panni né detersivi né solventi che possano danneggiare le superficie dei mobili  
Mobili per uso domestico all'interno della casa.

**DE**

### MONTAGEHINWEISE-GEBRAUCHSHINWEISE

Identifizieren Sie die Einzelteile  
Überprüfen Sie Die Anzahl der einzelnen Beschlagteile  
Legen Sie das notwendige Werkzeug bereit  
Bereiten die Montagefläche  
Montieren Sie das Möbel auf einem Teppich, sauberen Untergrund  
Niemals die verbindungen zu start anziehen  
Nicht neben Wärmequellen platzieren  
Vermeiden Sie Tücher und keinesfalls scharfe oder ätzende Reinigungsmittel.  
Möbel für den Gebrauch im Haus geeignet.

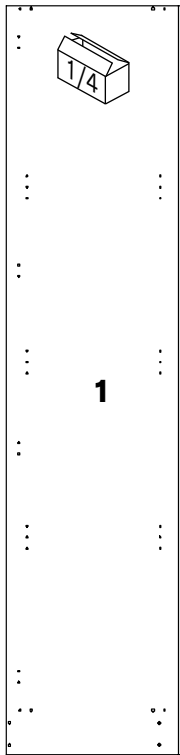

502 x 2160 mm.

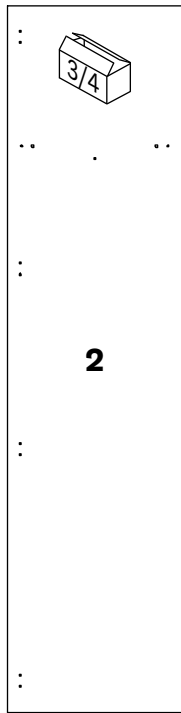

497 x 2039 mm.

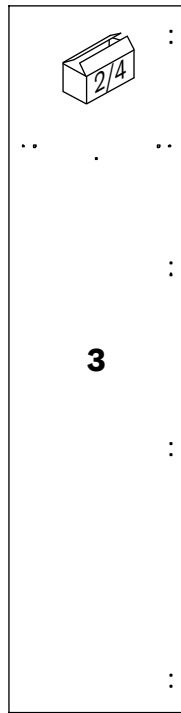

497 x 2039 mm.

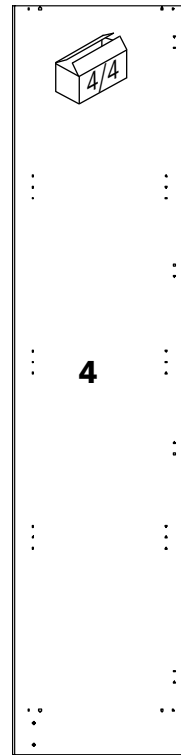

502 x 2160 mm.

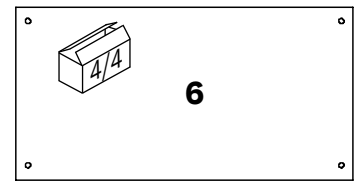

972 x 497 mm.

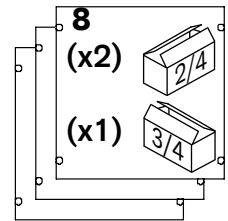

486 x 497 mm.

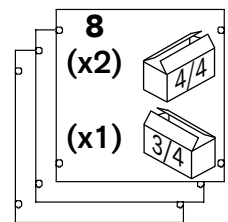

486 x 497 mm.

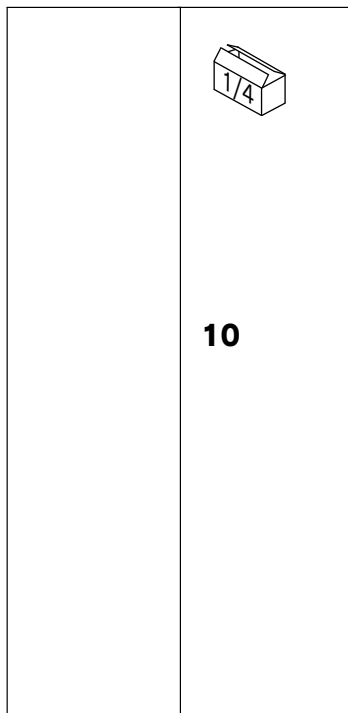

988 x 2071 mm.

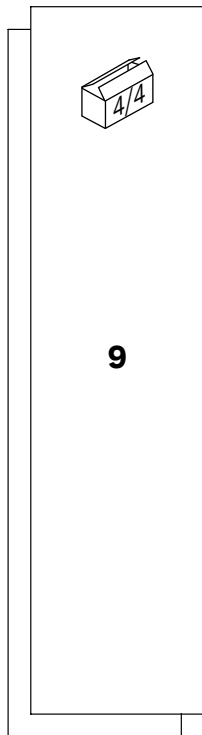

501 x 2071 mm.

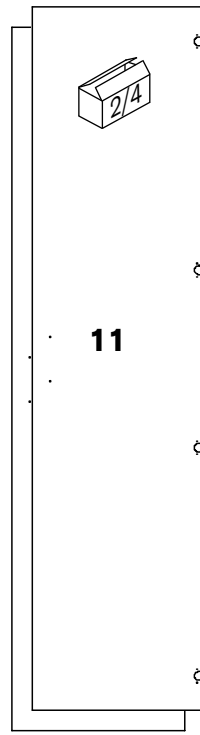

499 x 2062 mm.

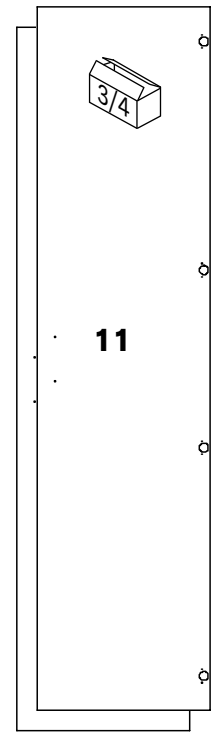

499 x 2062 mm.

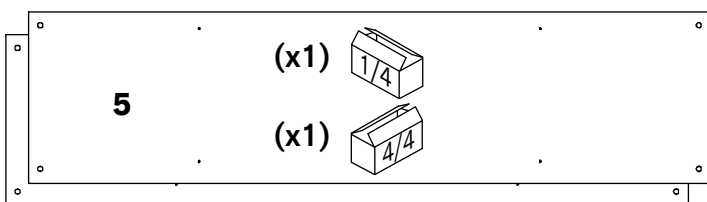

1976 x 497 mm.

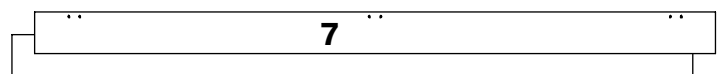

1974 x 88 mm.

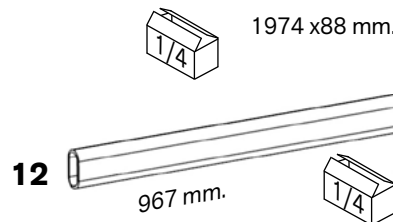

967 mm.

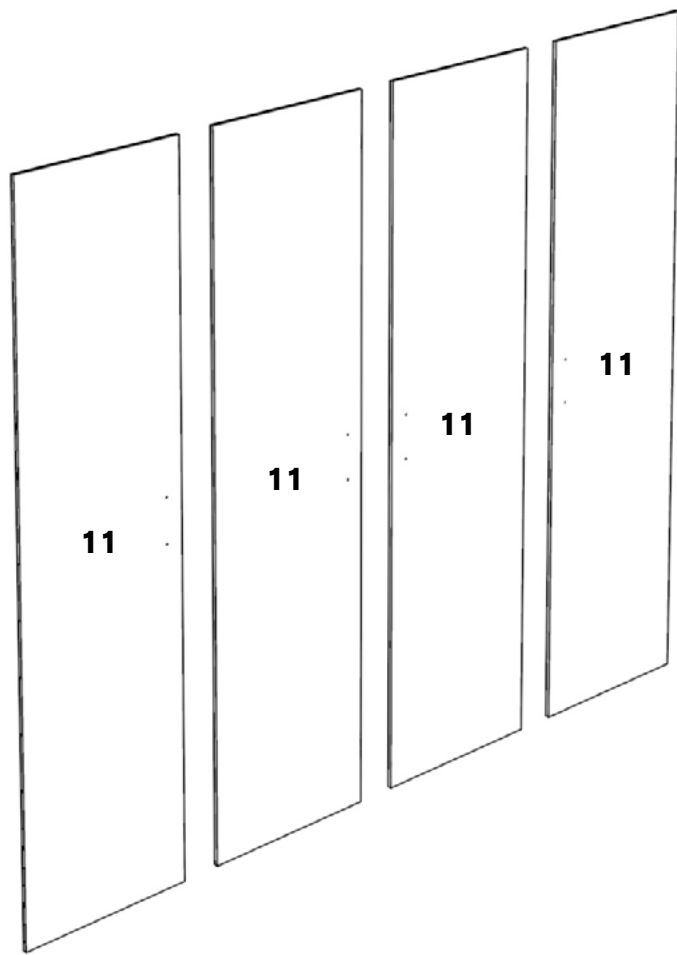
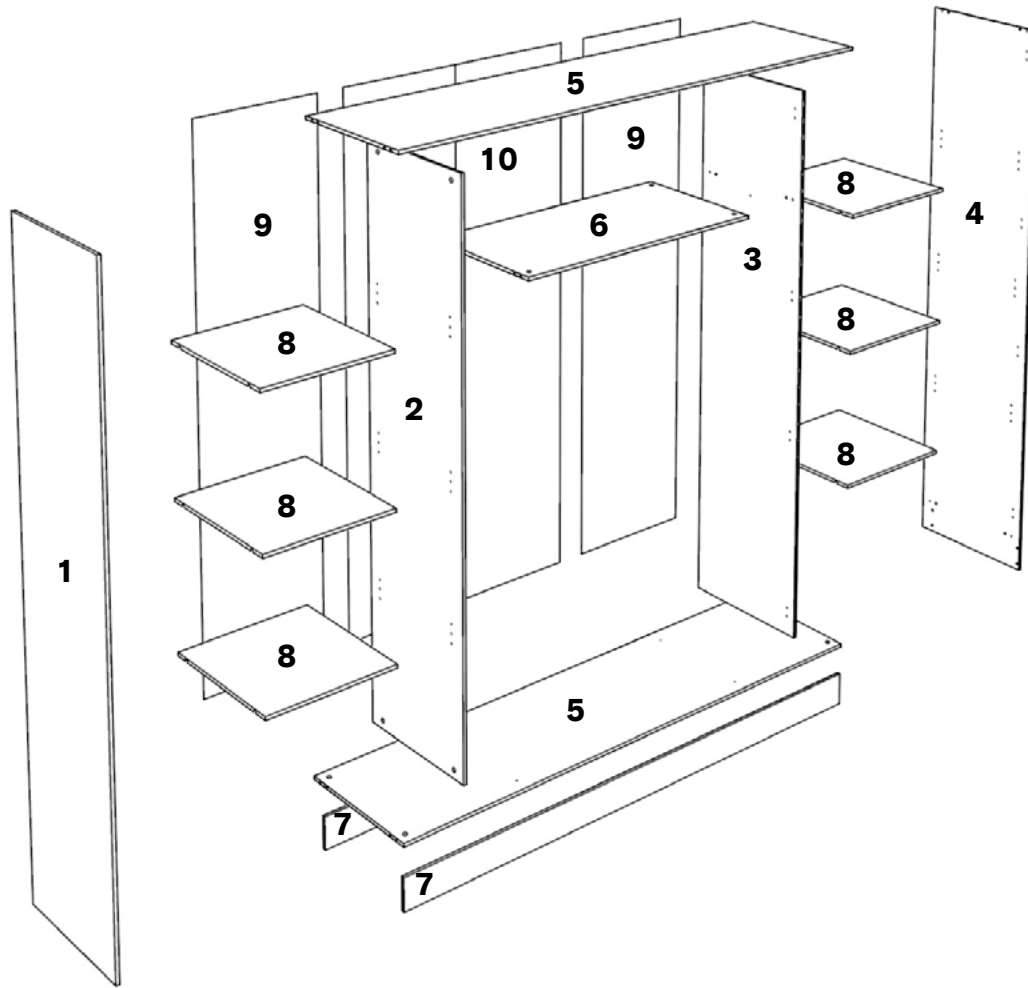

1

B x 04

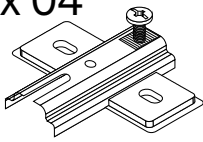

D x 02

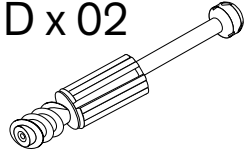

G x 10



3.5 x 15 mm.

L x 01

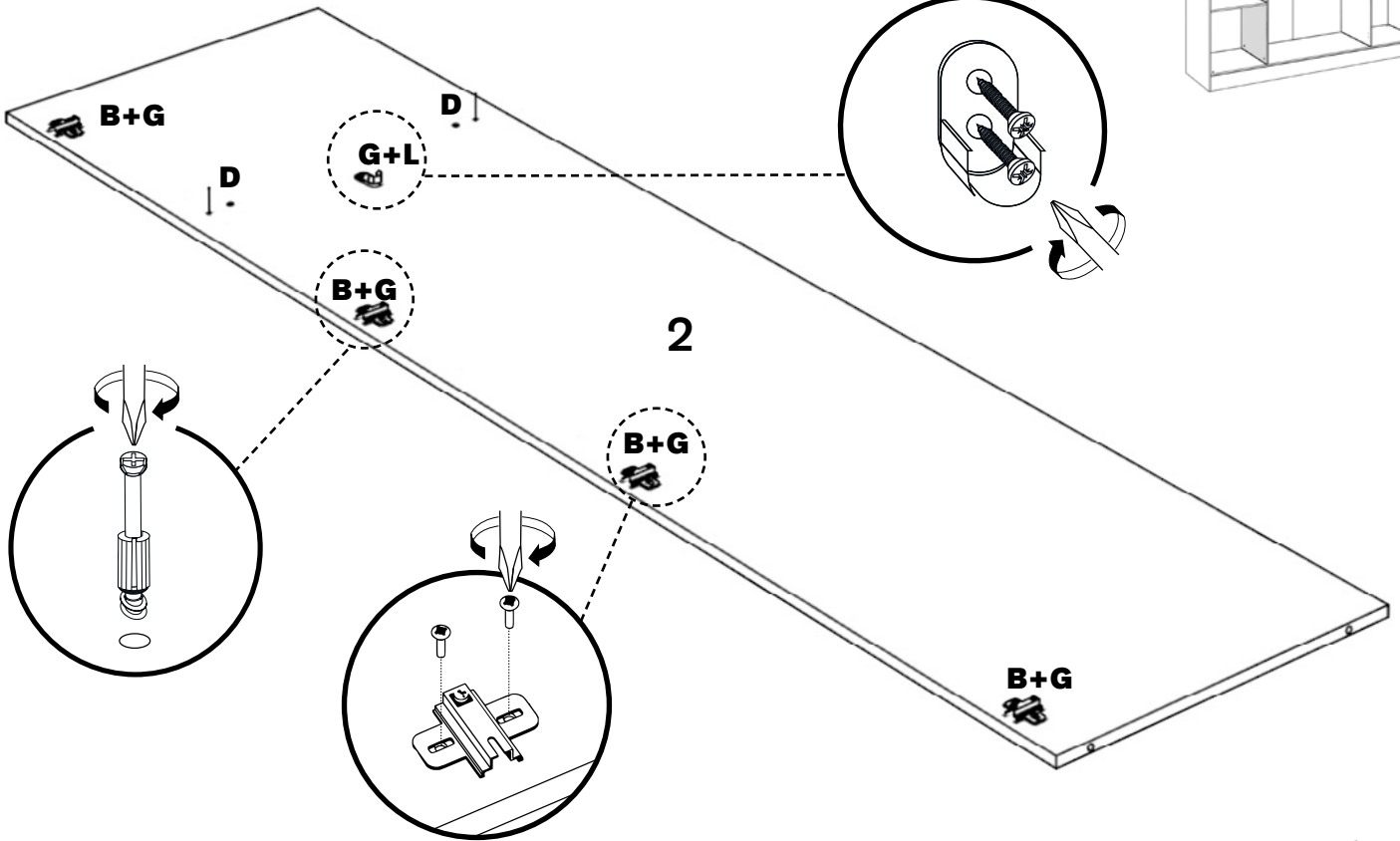
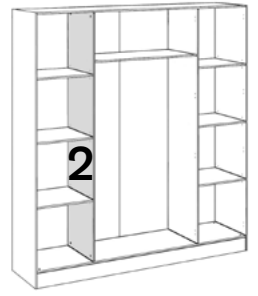
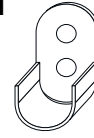

2

E x 04

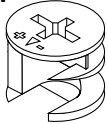

Ñ x 06

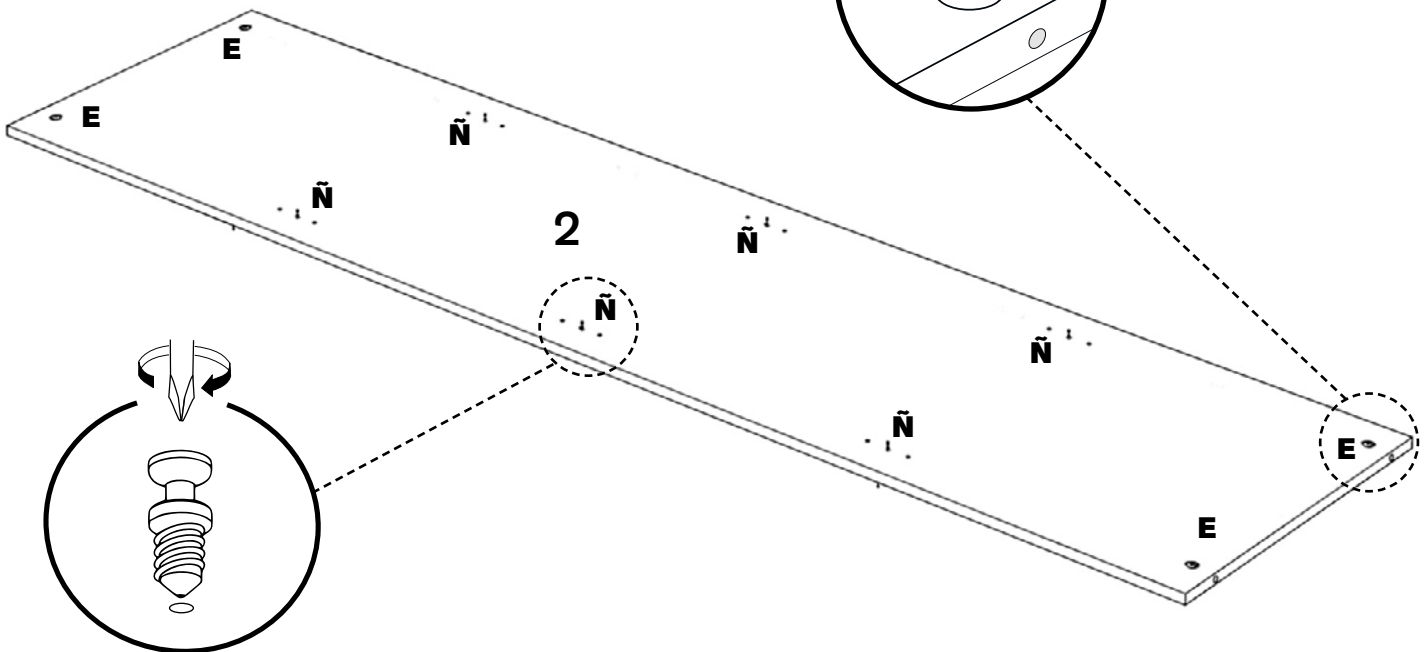
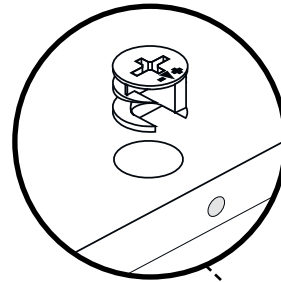
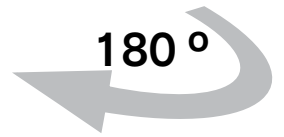

3

B x 04

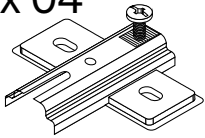

D x 02

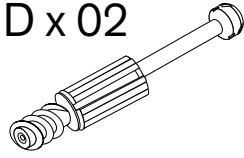

G x 10



3.5 x 15 mm.

L x 01

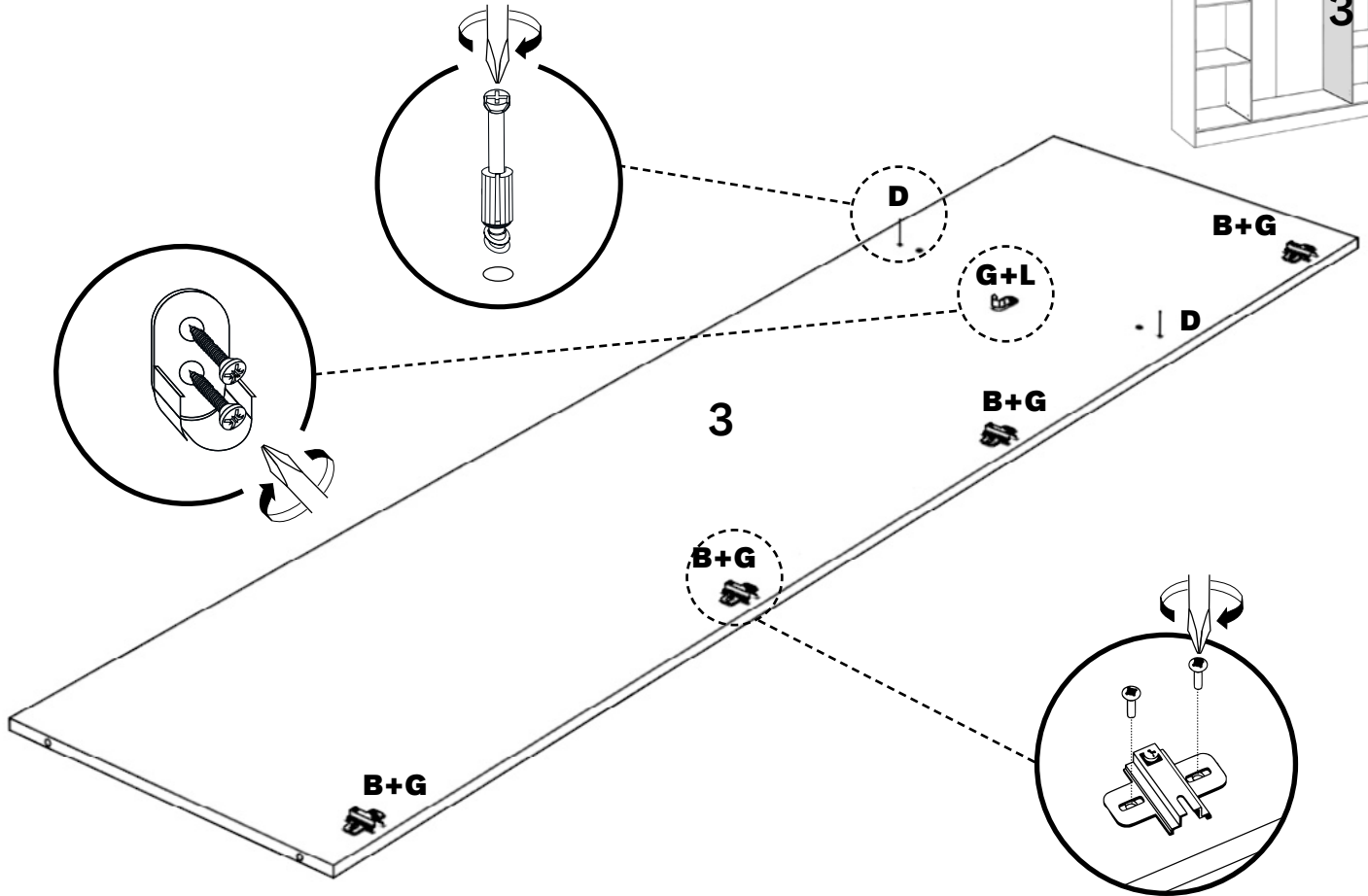
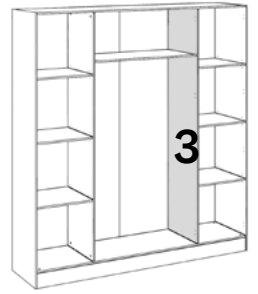
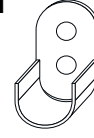

4

E x 04

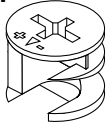

Ñ x 06

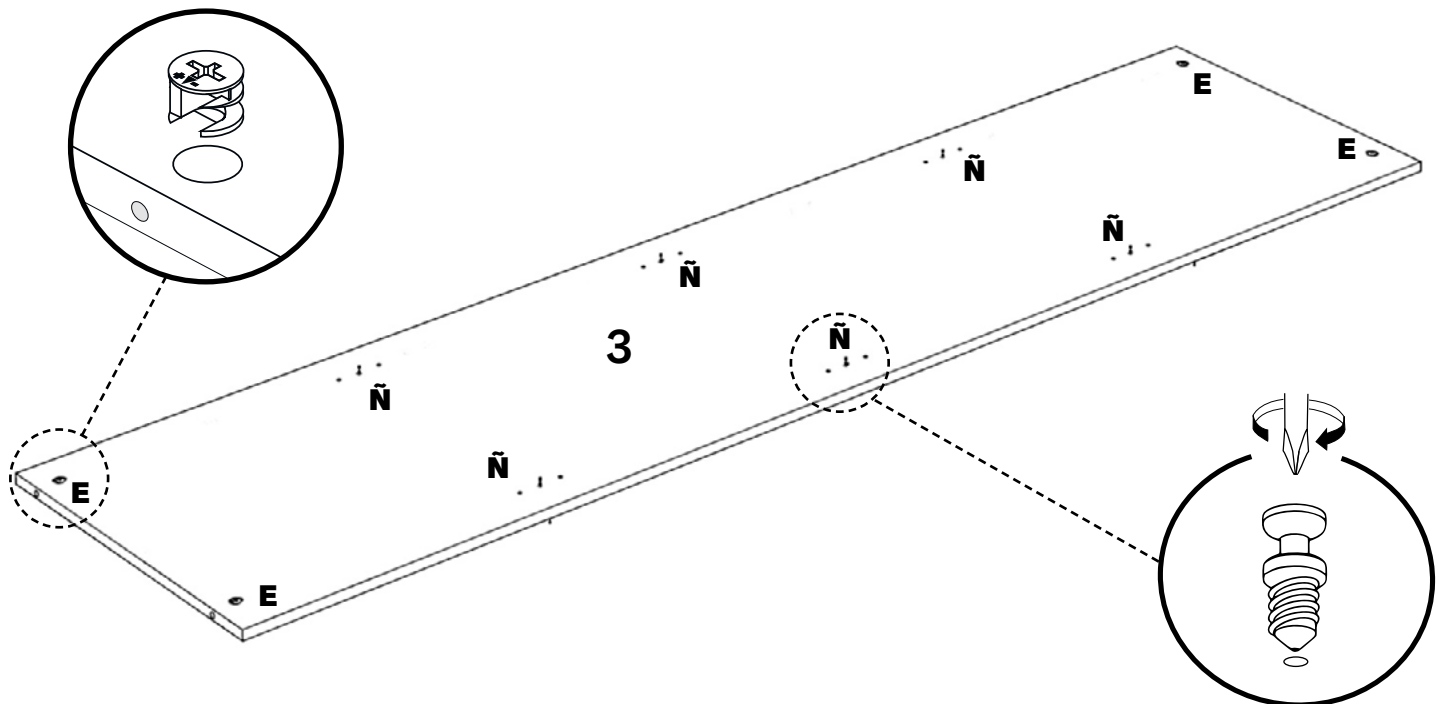
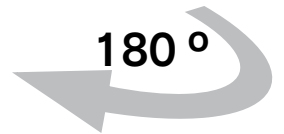

5

C x 08

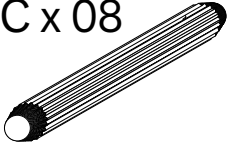

D x 08

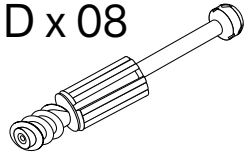

E x 08

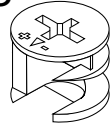

5

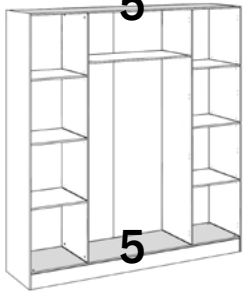

5

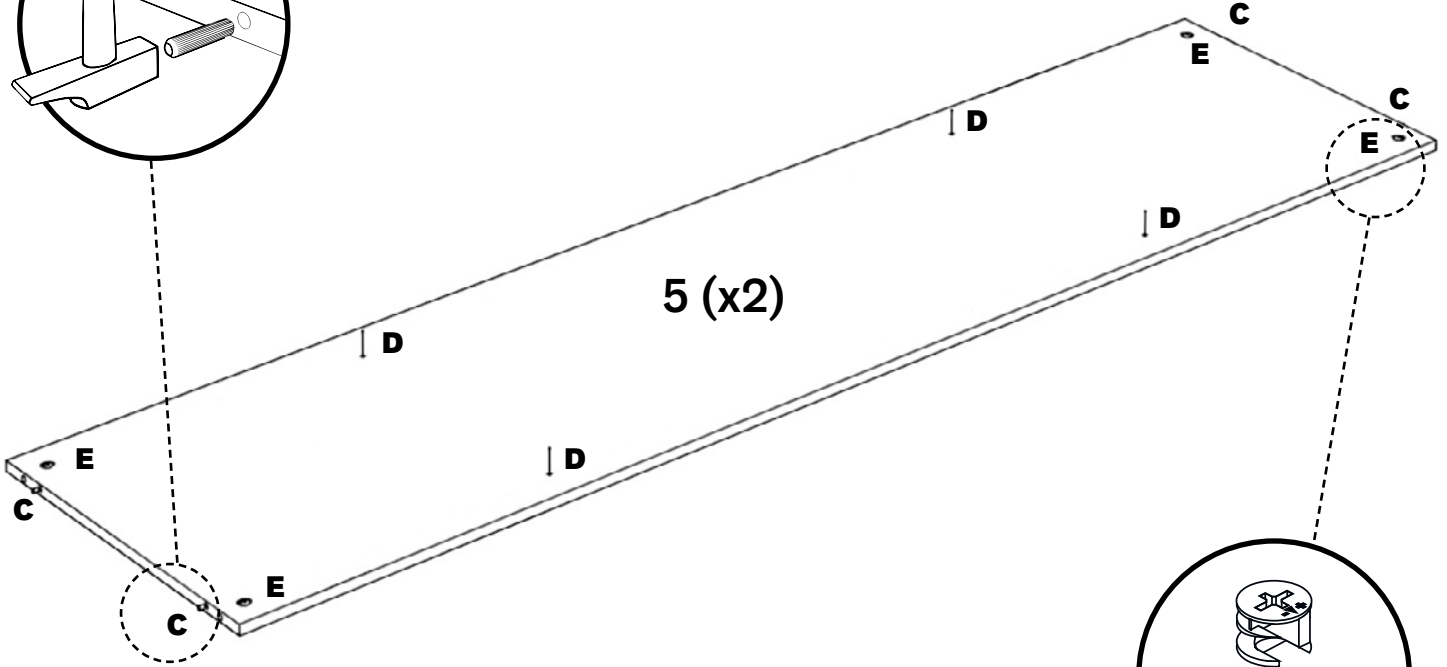
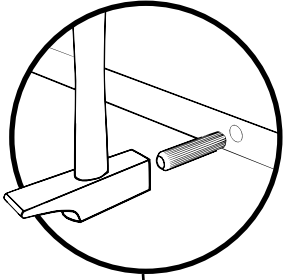

6

C x 04

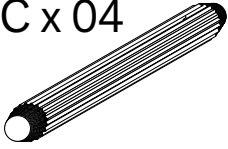

E x 04

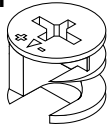

6

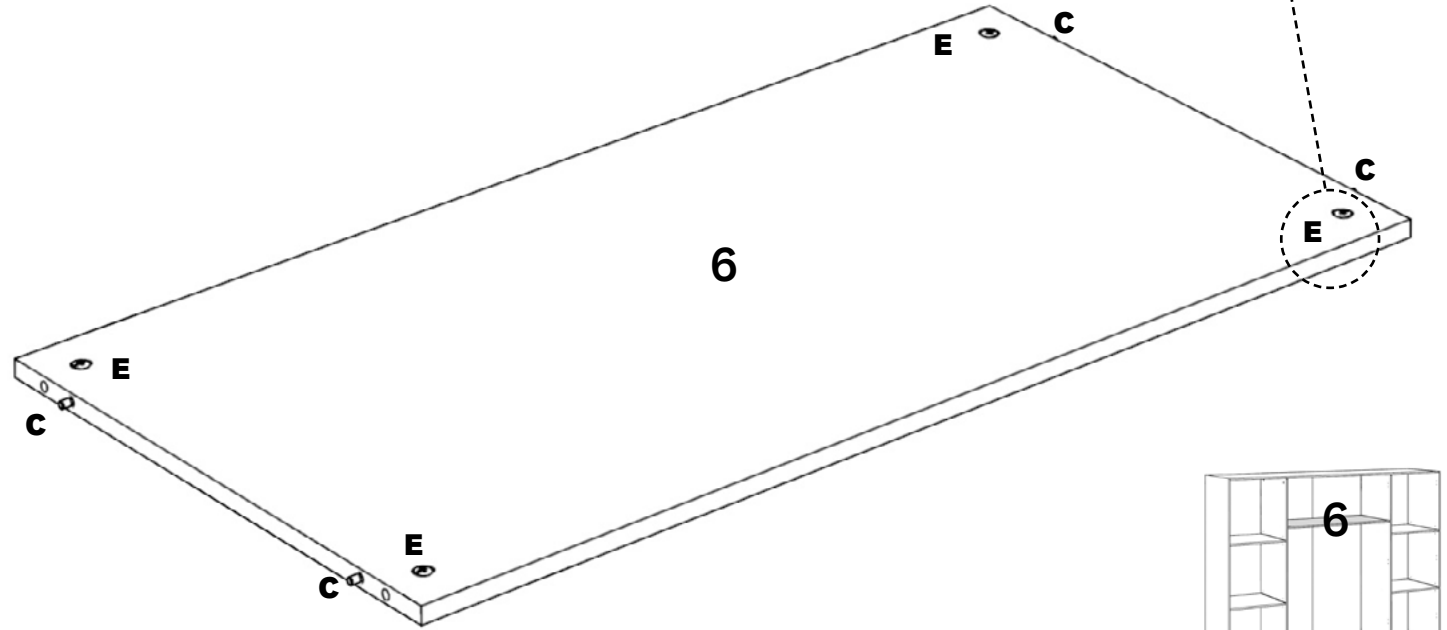
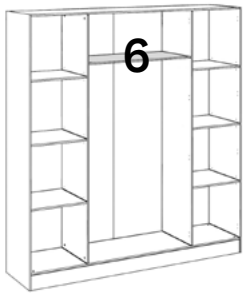

7

Px01

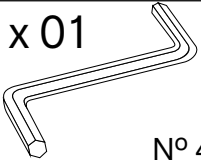

N° 4

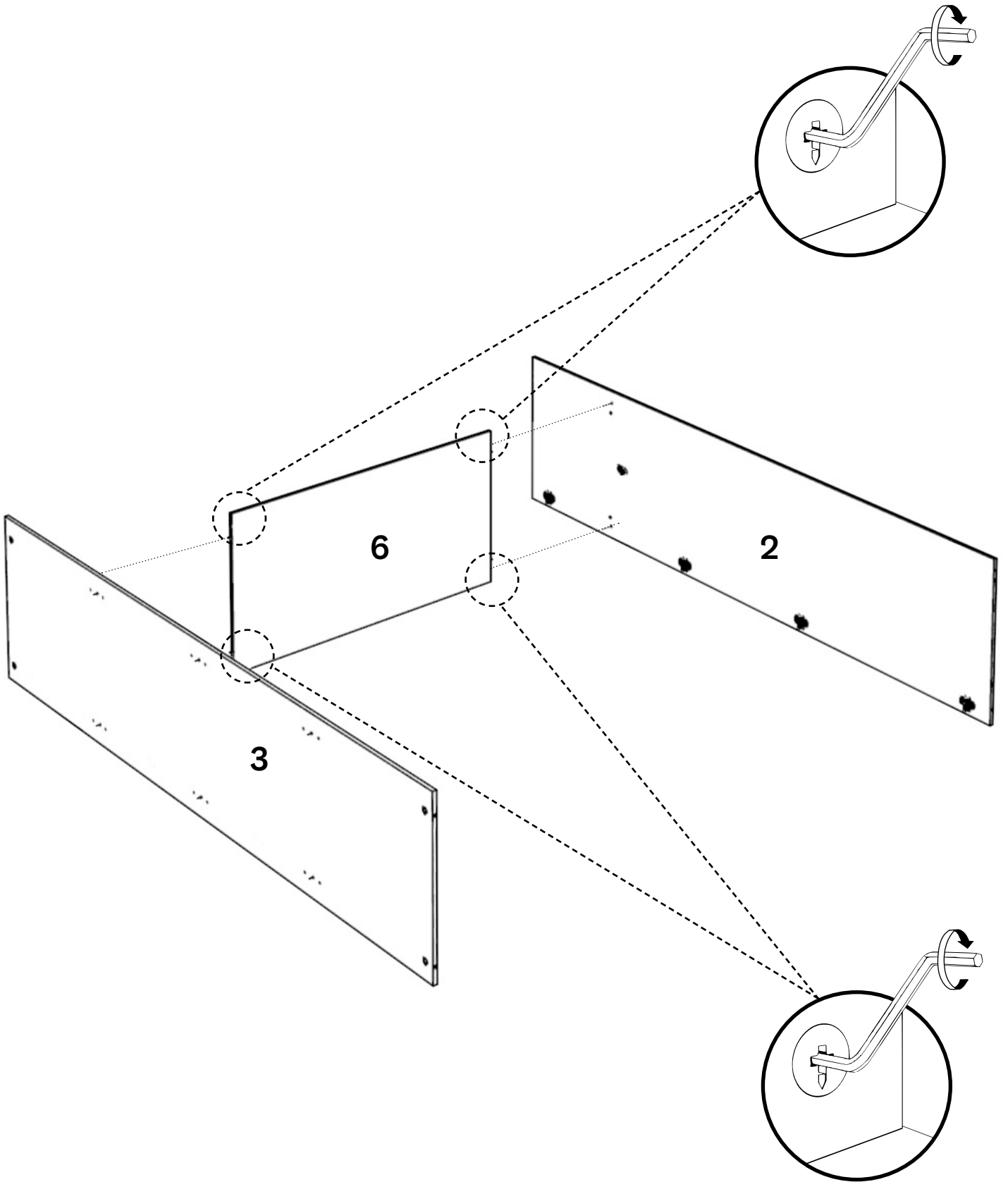

8

P x 01

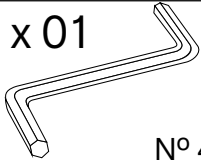

N° 4

Q x 08

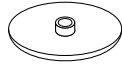

15 mm.

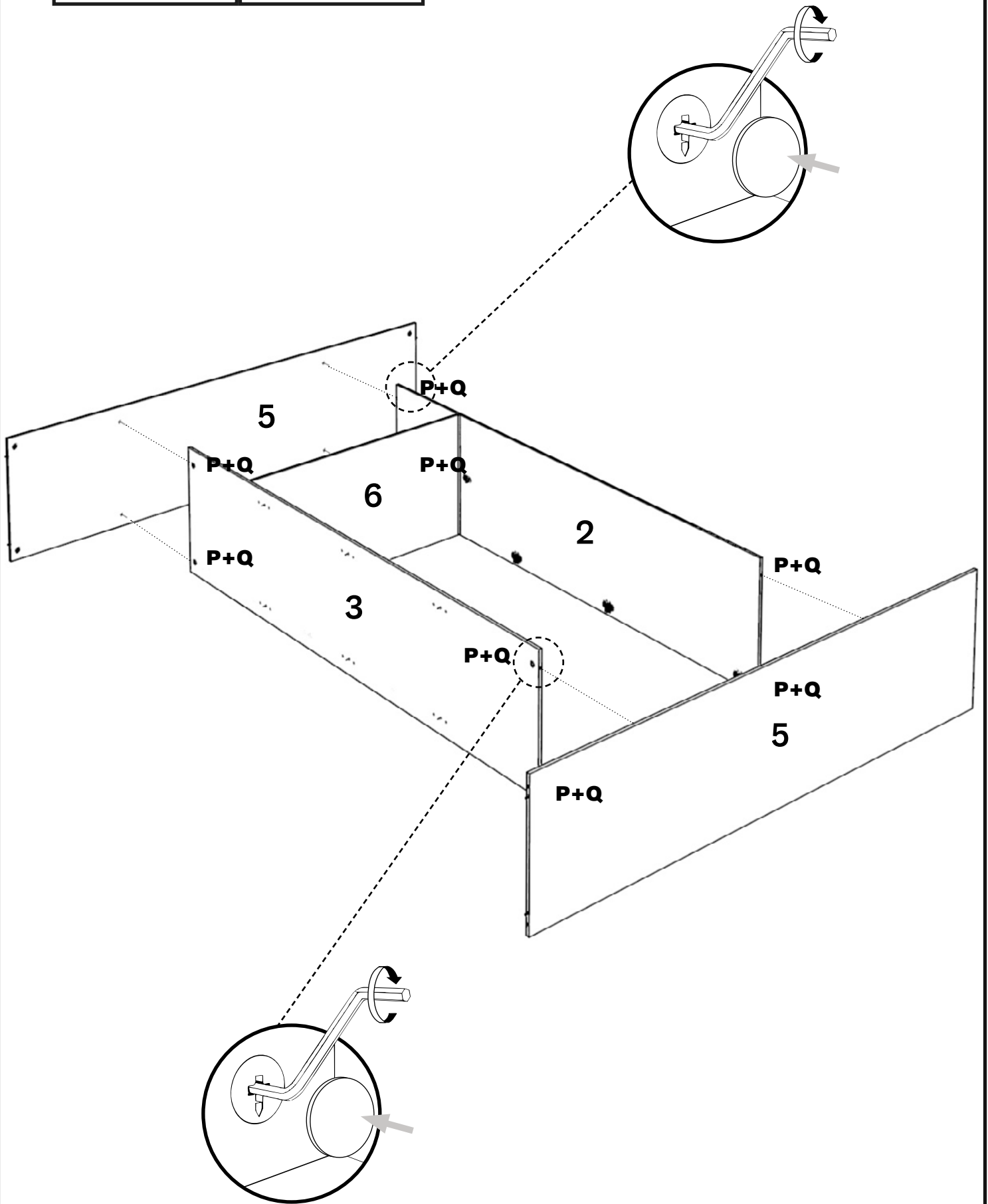

9

B x 04

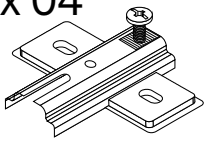

D x 04

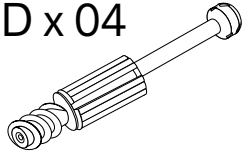

G x 08



3.5 x 15 mm.

J x 02



Ñ x 06

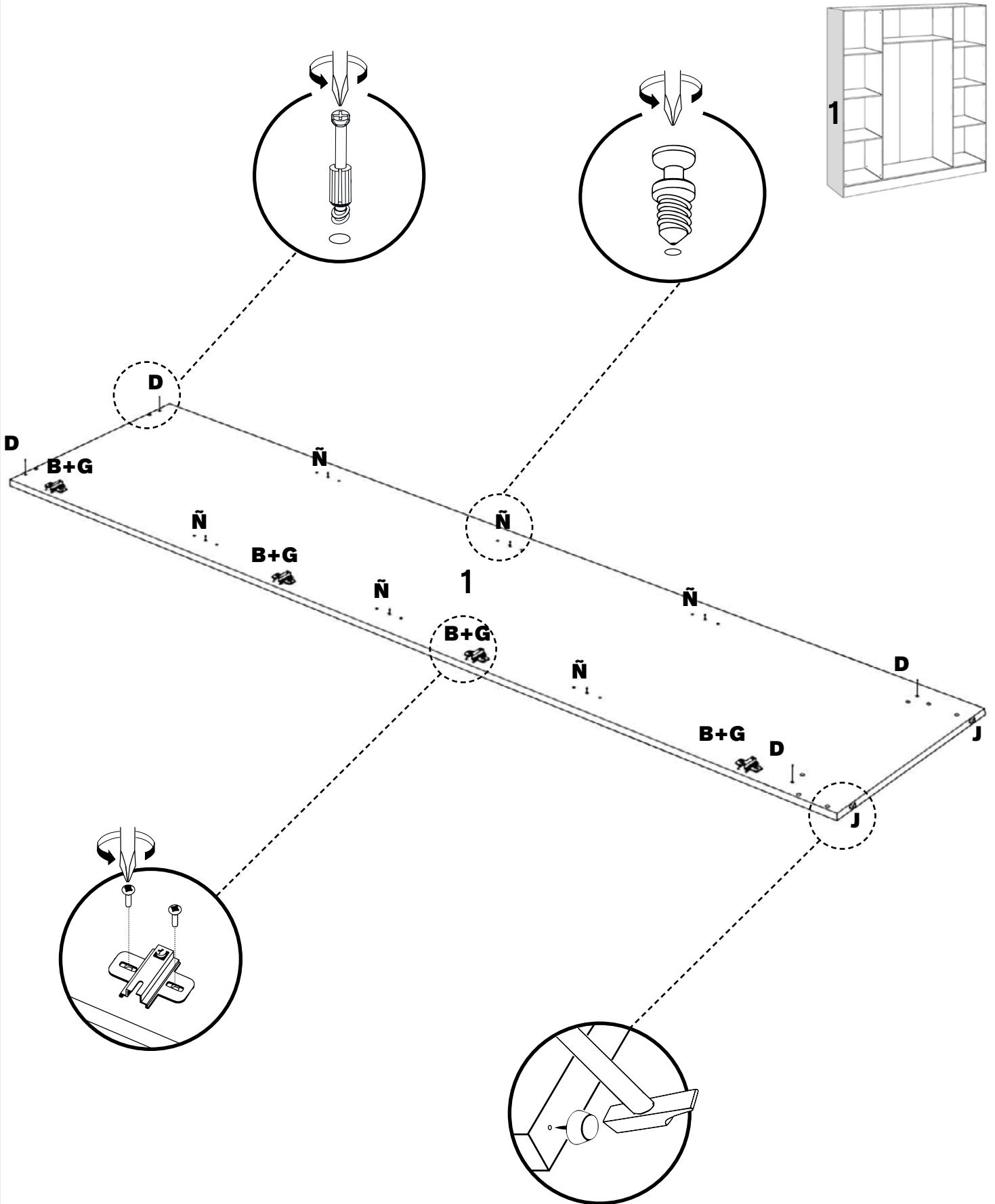
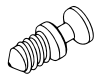

10

B x 04

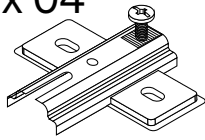

D x 04

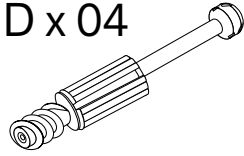

G x 08



3.5 x 15 mm.

J x 02

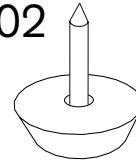

Ñ x 06

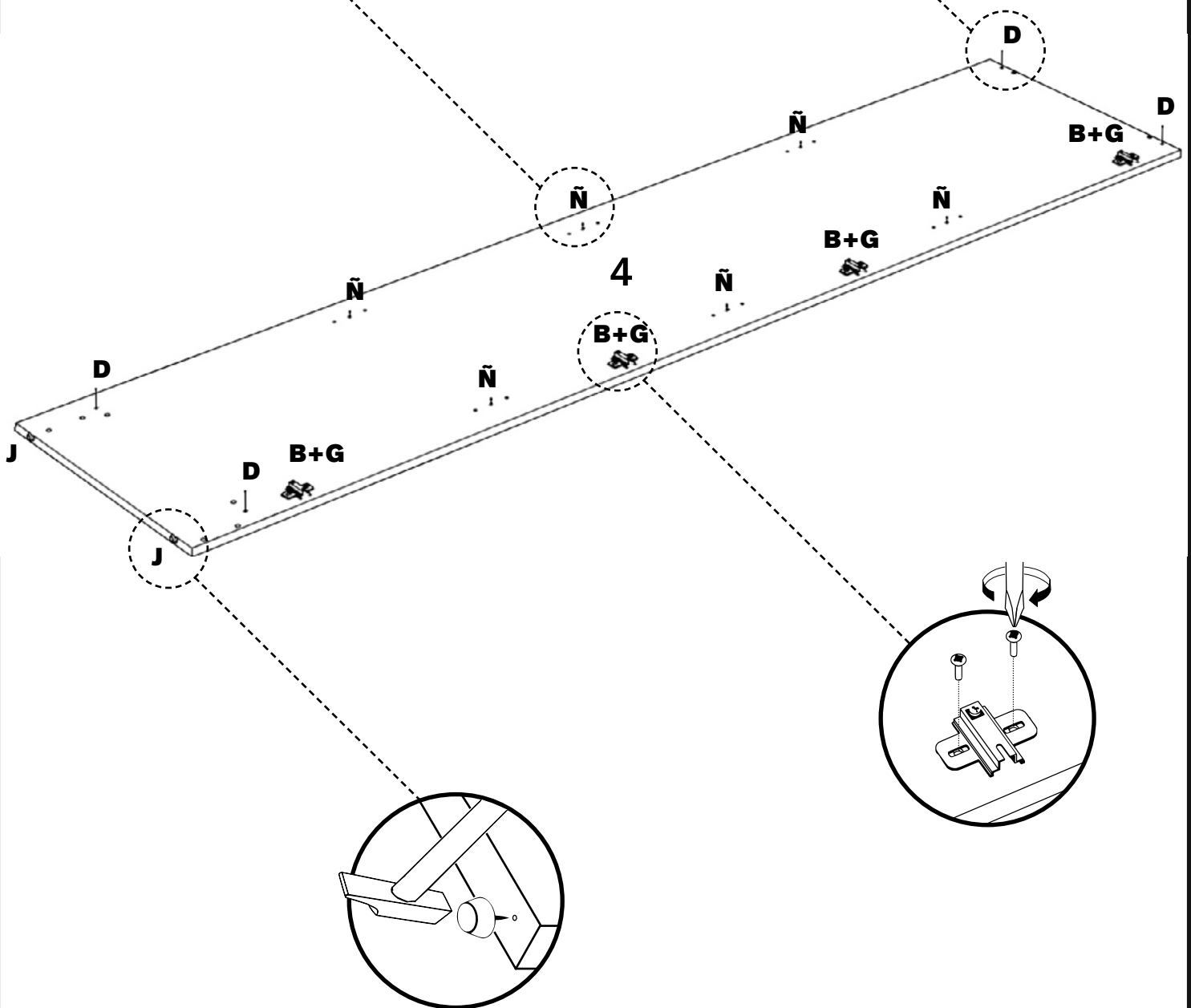
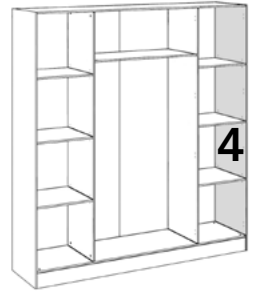
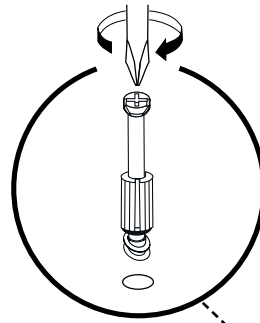
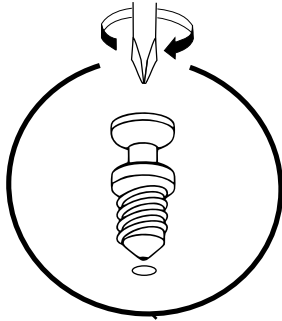
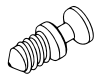

11

C x 08

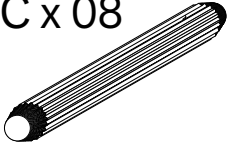

J x 04

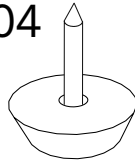

G x 12



3.5 x 15 mm.

K x 06

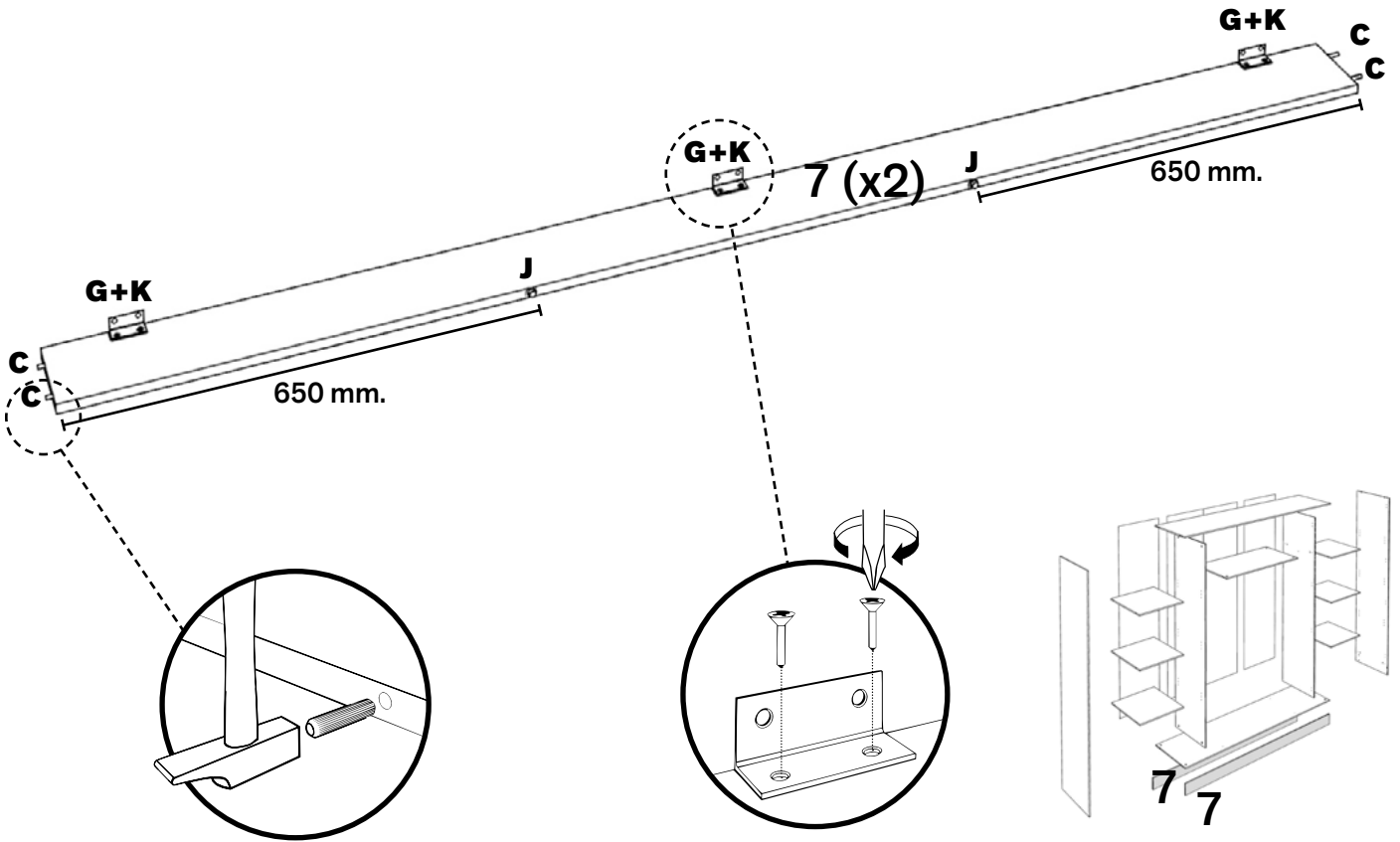
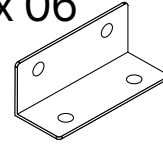

12

O x 24

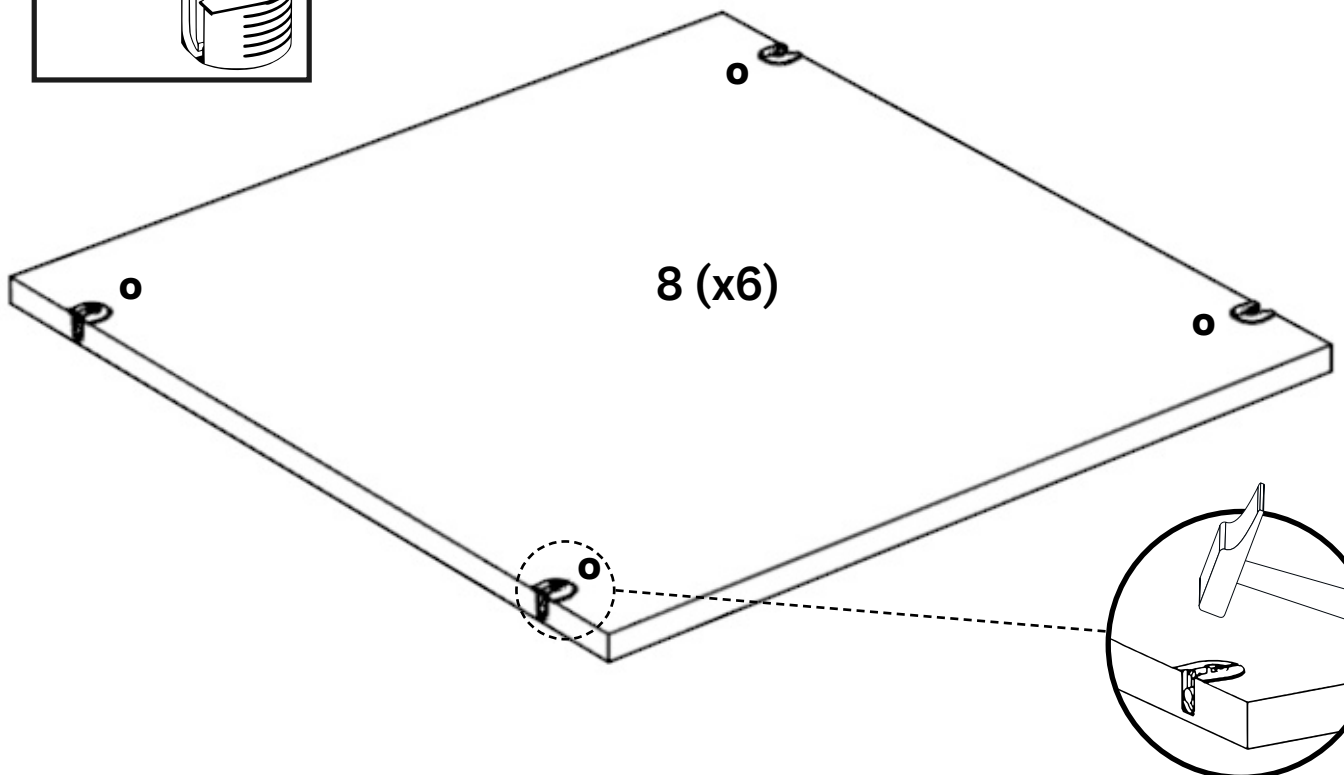
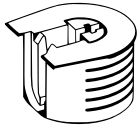

13

P x 01

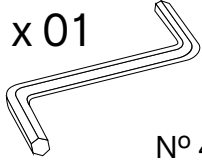

N° 4

Q x 08

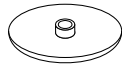

15 mm.

G x 12



3.5 x 15 mm.

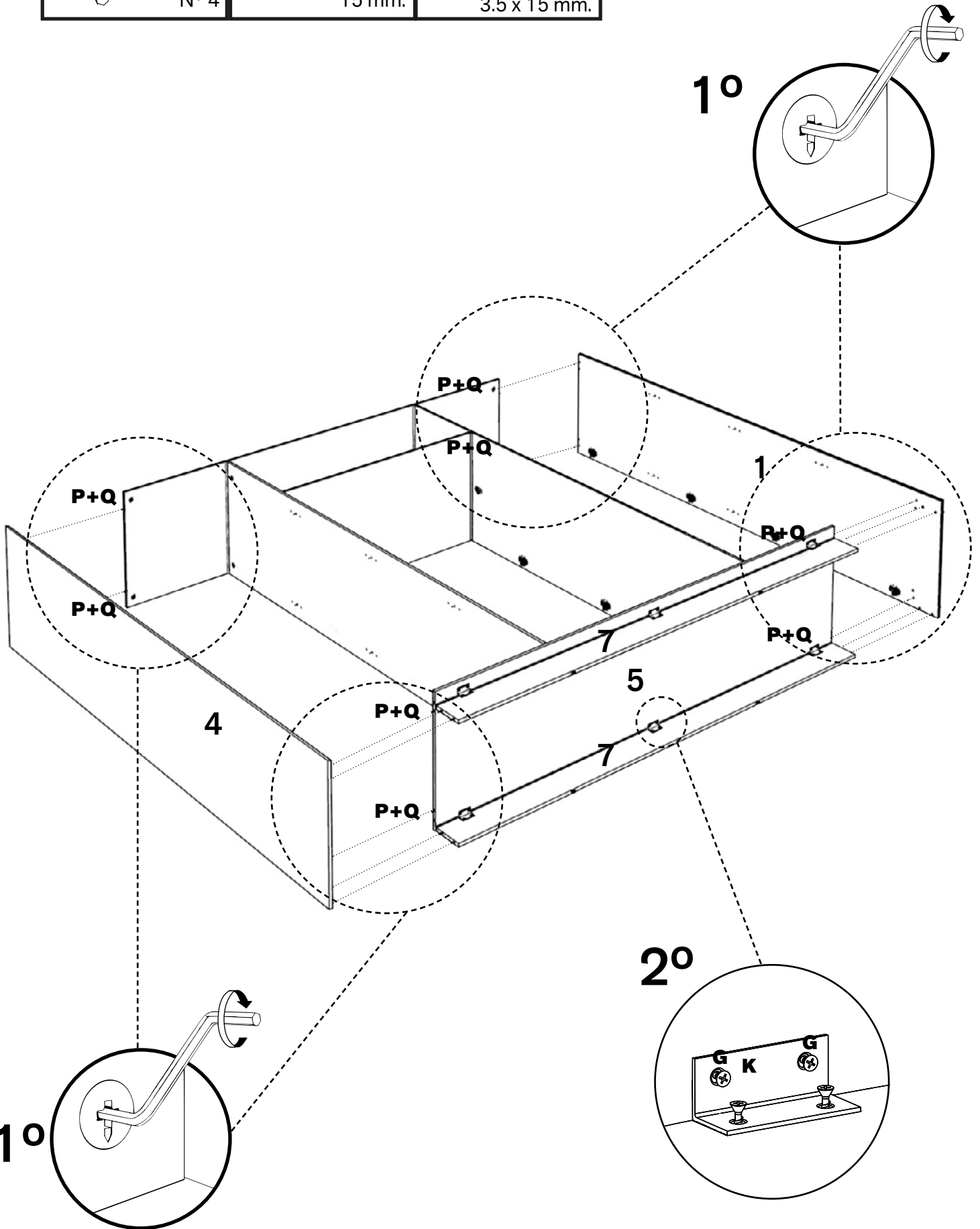

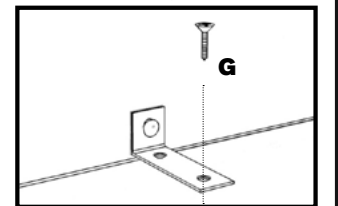
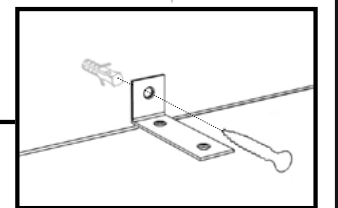
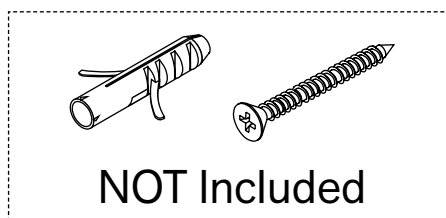
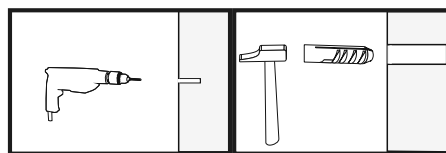
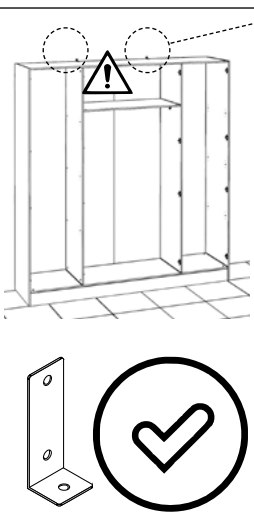
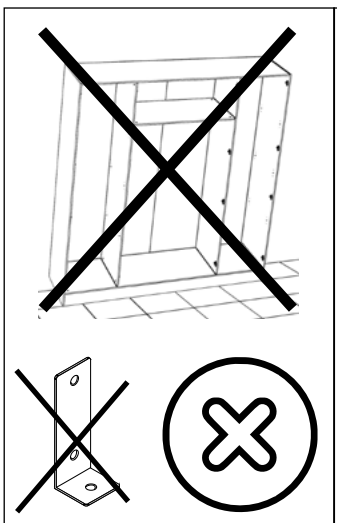
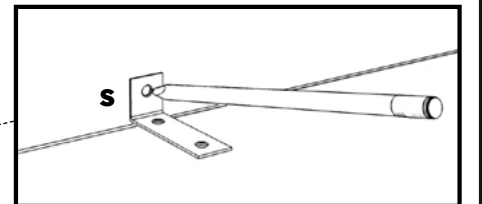
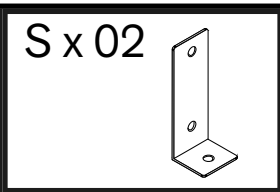
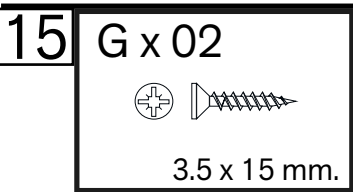
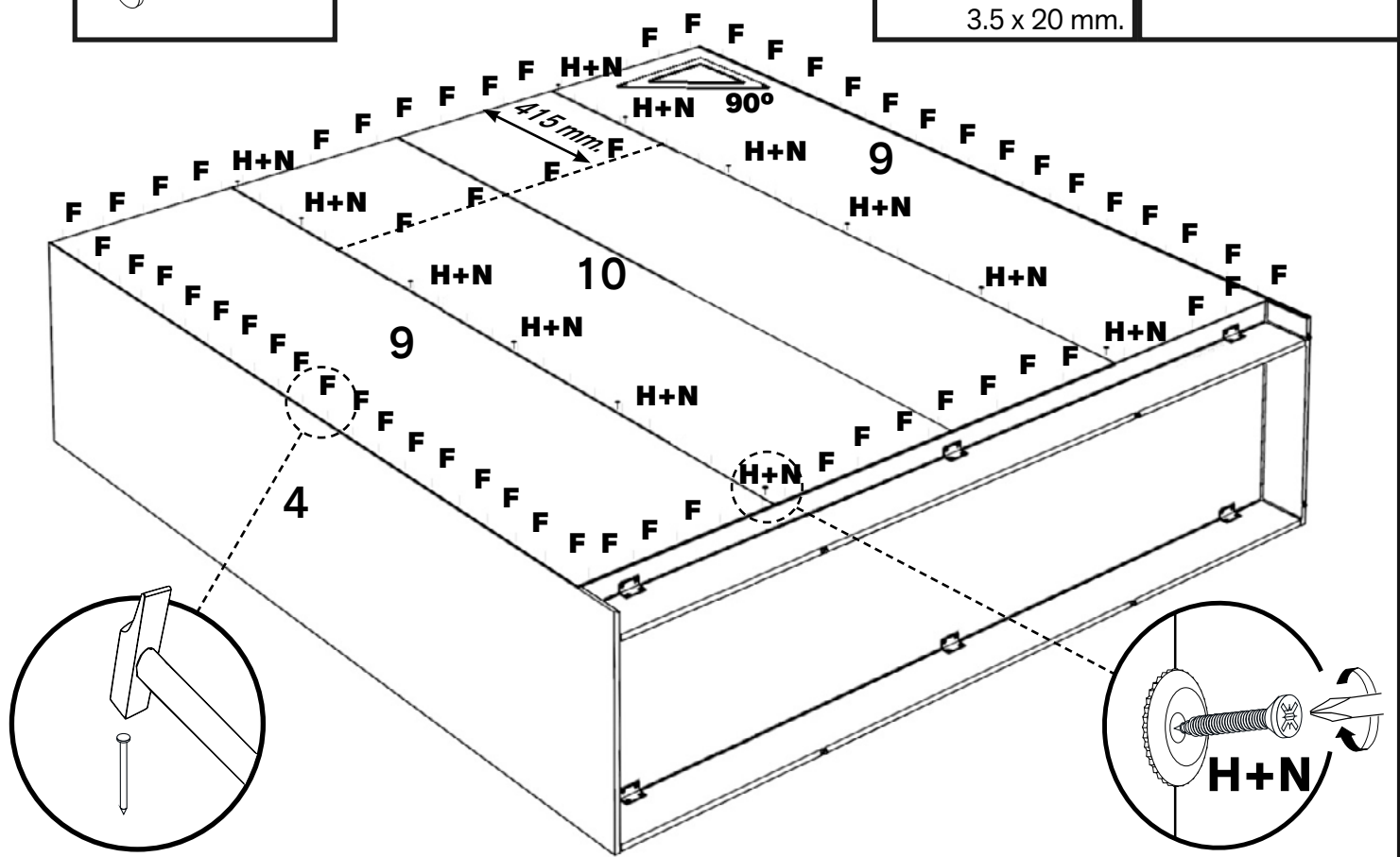
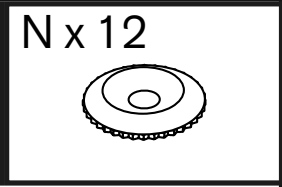
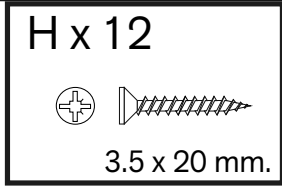
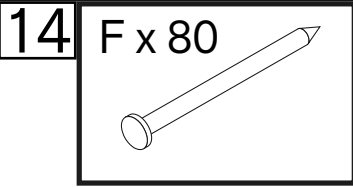

**EN**  
For your safety always fix the furniture to the wall. Use wall plugs and screws appropriate for your type of wall.

**ES**  
Por su seguridad fijar siempre el mueble a la pared. Use tacos y tornillos adecuados para su tipo de pared.

**FR**  
Pour votre sécurité, fixez toujours les meubles au mur. Utilisez des chevilles et des vis adaptées à votre type de mur.

**PT**  
Para sua segurança, prenda sempre os móveis à parede. Use buchas e parafusos adequados para o seu tipo de parede.

**IT**  
Per la tua sicurezza fissa sempre i mobili al muro. Utilizzare tasselli e viti appropriati per il tipo di muro.

**DE**  
Befestigen Sie die Möbel zu Ihrer Sicherheit immer an der Wand. Verwenden Sie für den Wandtyp geeignete Anker und Schrauben.

16

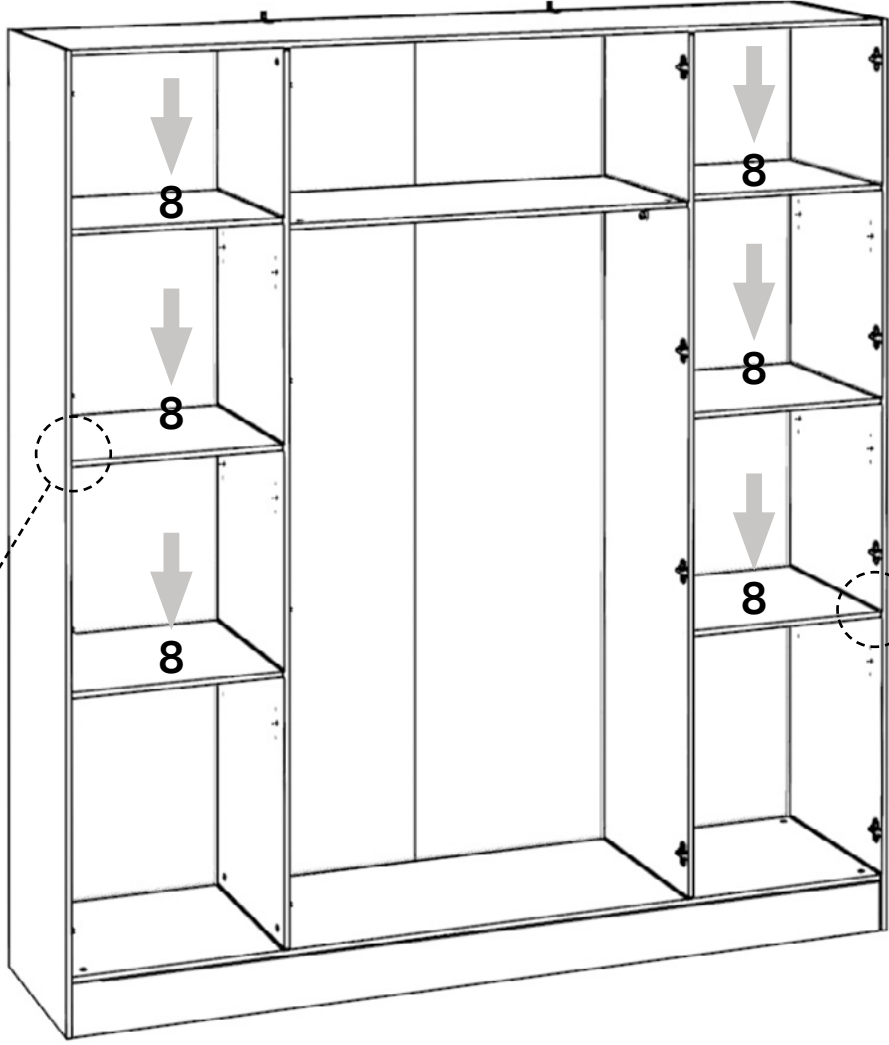

17

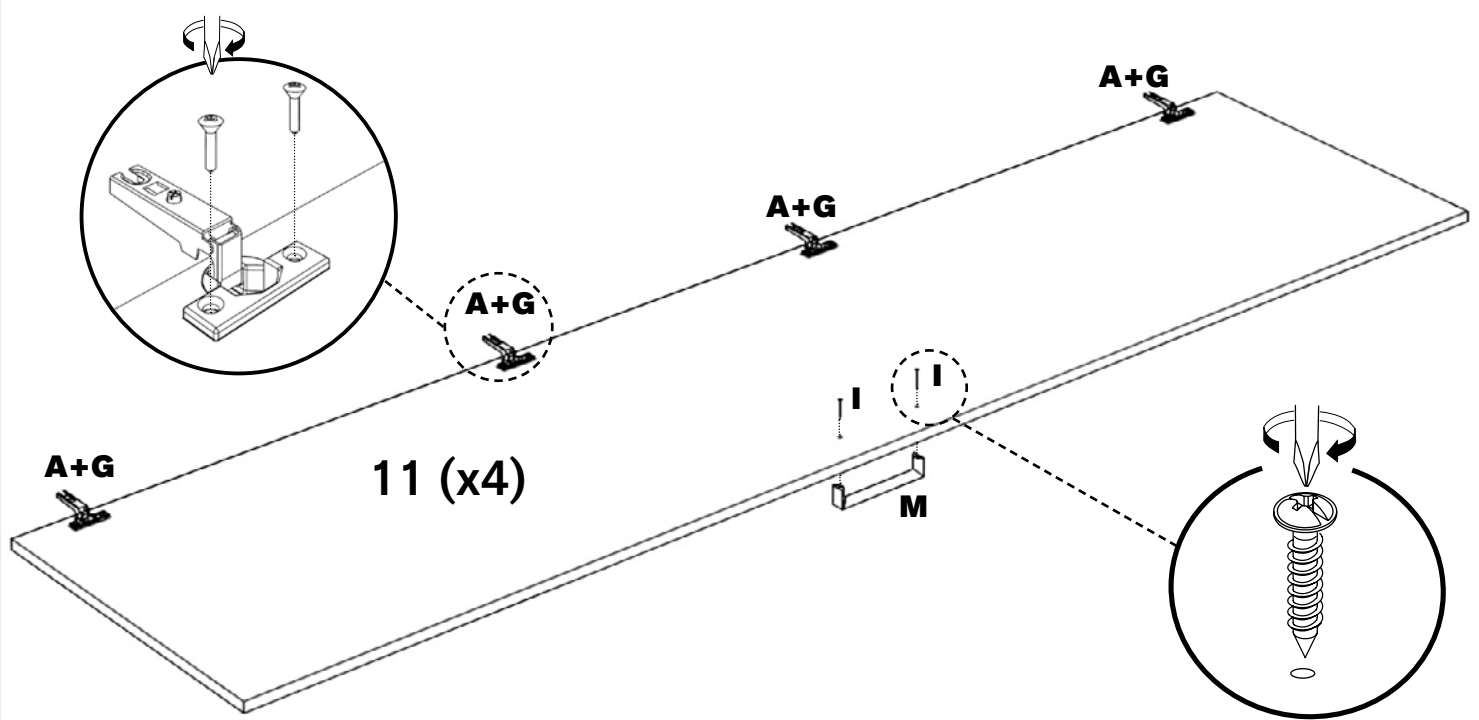
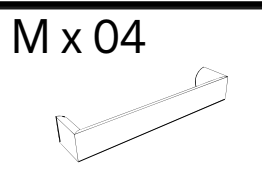
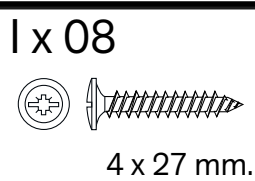
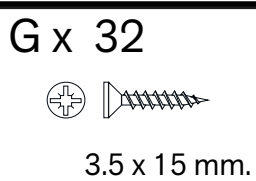
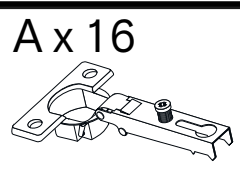

18 R x 08  
7 mm.

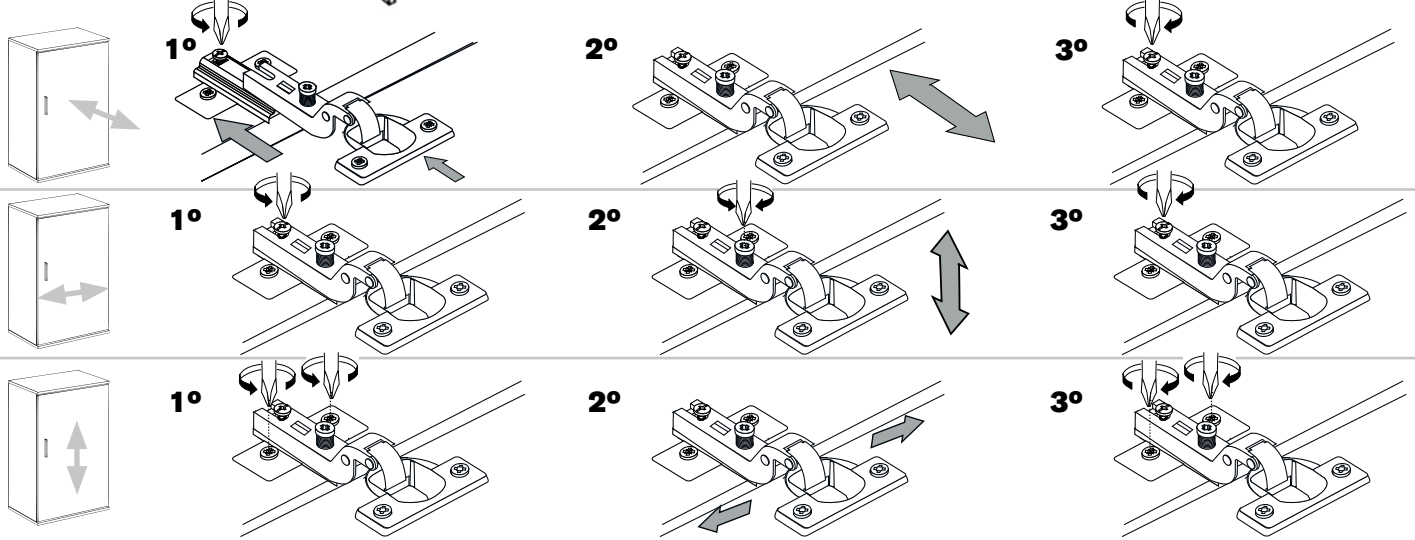
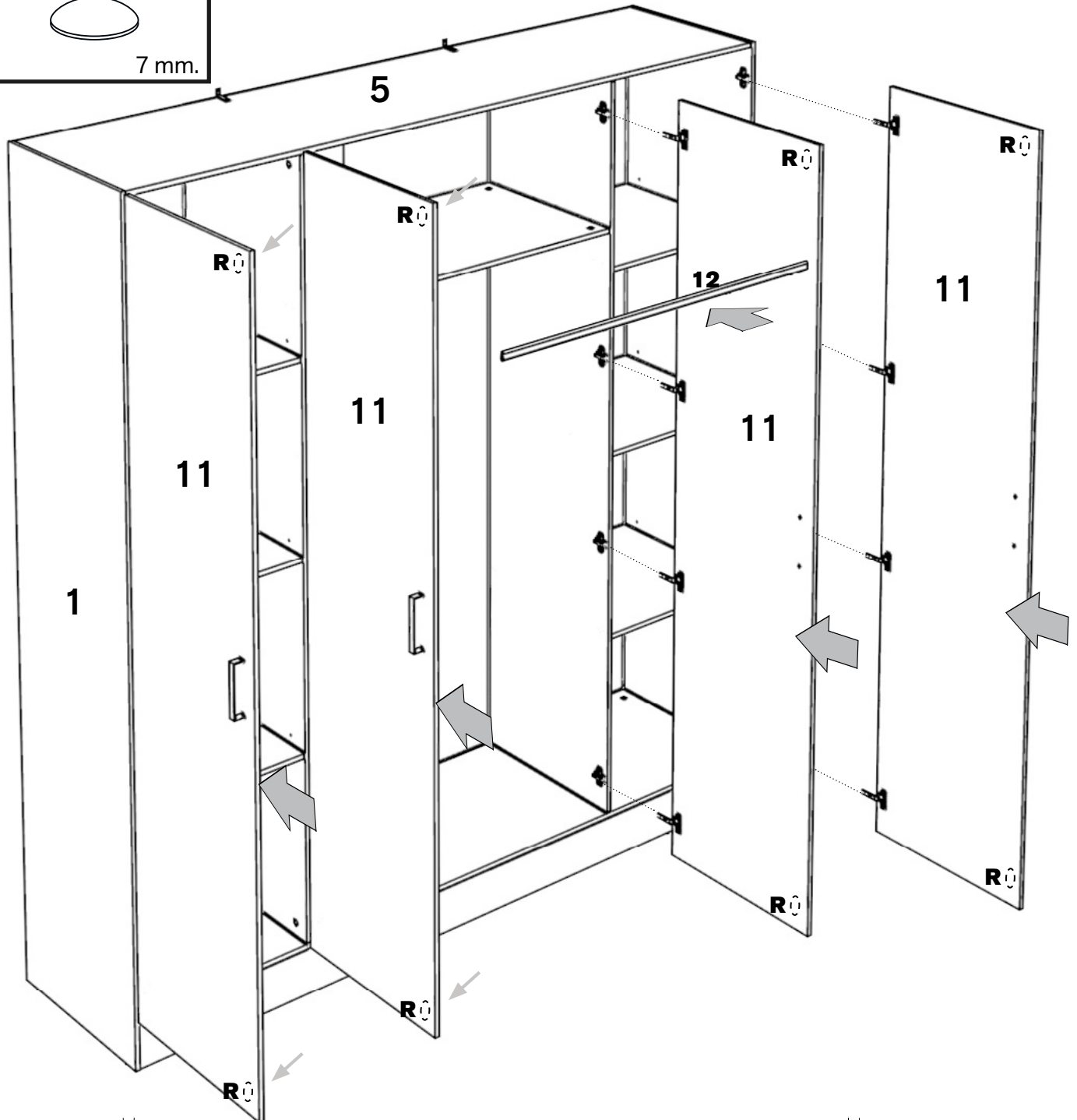

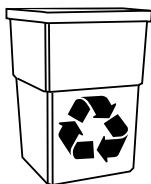

PLÁSTICO  
PLASTIC  
PLASTIQUE

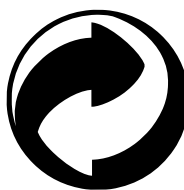

PEFC™  
PEFC/14-35-00462  
Promoting Sustainable  
Forest Management  
www.pefc.org

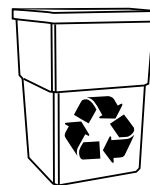
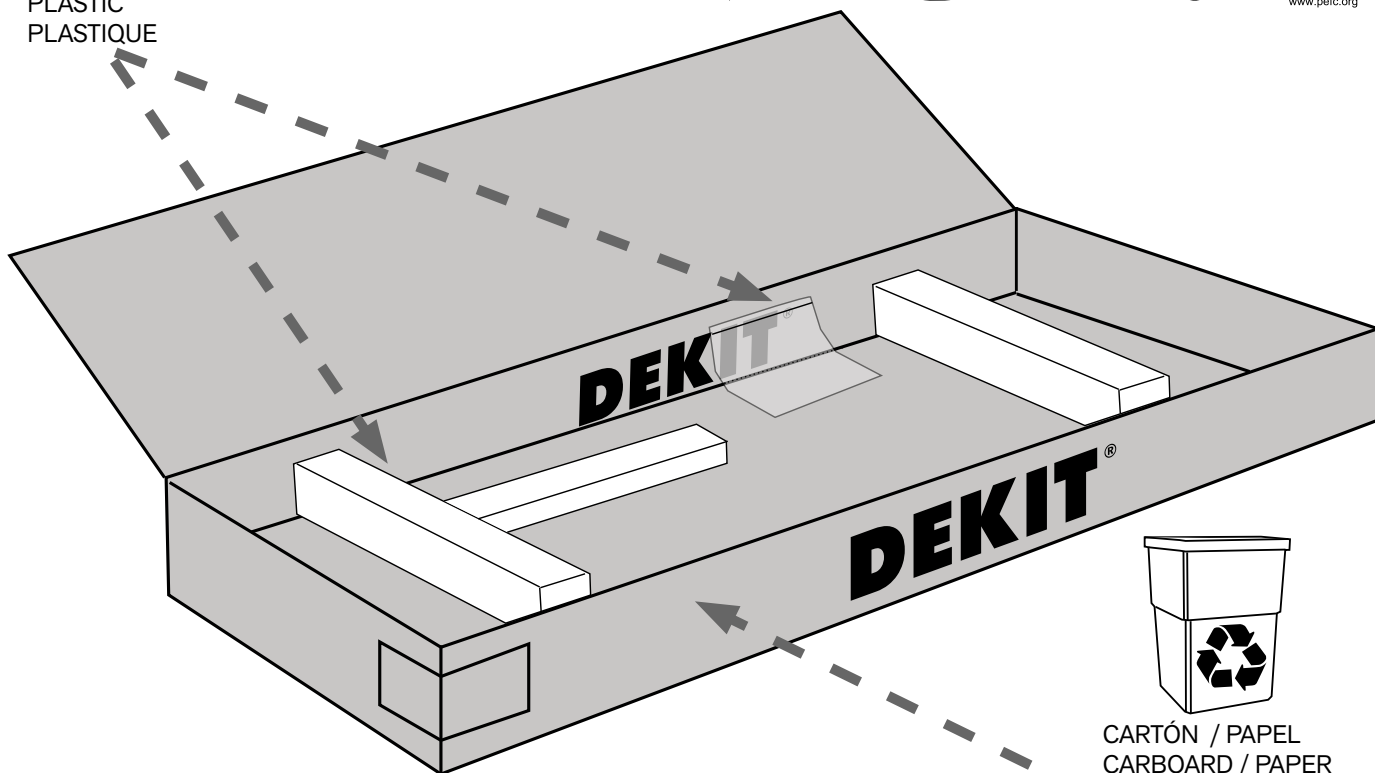

CARTÓN / PAPEL  
CARBOARD / PAPER  
CARTON / PAPIER

## GARANTÍA - GUARANTEE - GARANTIE - GARANTIA - GARANZIA

### ES

Fabricado en la U.E. por CIF A-12045134. Dirección: Ctra Vinaròs-Ulldecona, km 1 12500 Vinaròs Castellón ESPAÑA. Garantía de 3 años a partir fecha compra contra todo defecto de fabricación del producto. La garantía no incluye los defectos de mal montaje o mal uso del mueble. Para cualquier defecto en el mueble o dificultades durante el montaje, por favor contacte con el establecimiento o sitio web donde compró el mueble. Es necesario conservar el ticket de compra y el N° de Control de Calidad en caso de consulta o reclamación.

### EN

Manufactured in the E.U. by CIF A-12045134, Address: Ctra Vinaròs-Ulldecona, km 1 12500 Vinaròs Castellón SPAIN. Guarantee of 3 years from the date of purchase against any manufacturing defect of the product. The guarantee does not include defects during the assembly or misuse of the furniture.

For any furniture defect of any difficulties during the assembly, please contact with the store or website where you purchased the furniture. It is necessary to keep the purchase ticket and the Quality Control N° in case of any question or claim.

### FR

Fabriqué dans l'U.E. par CIF A-12045134, Adresse: Ctra Vinaròs-Ulldecona, km 1 12500 Vinaròs Castellón ESPAGNE. Garantie de 3 ans à compter de la date d'achat contre tout défaut de fabrication du produit. La garantie ne couvre pas les défauts dus à un mauvais montage ou à une mauvaise utilisation du meuble.

Pour tout défaut du meuble ou difficultés lors du montage, veuillez contacter le magasin ou la web où vous avez acheté le meuble. Il est nécessaire de conserver la facture d'achat et le numéro de contrôle qualité en cas de demande d'information ou de réclamation.

### PT

Fabricado na U.E. por CIF A-12045134, Endereço: Ctra Vinaròs-Ulldecona, km 1 12500 Vinaròs Castellón ESPANHA. Garantia de 3 anos a partir da data de compra contra qualquer defeito de fabricação do produto. A garantia não inclui defeitos decorrentes de má montagem ou mau uso do móvel. Para qualquer defeito nos móveis ou dificuldades durante a montagem, entre em contato com a loja ou site onde comprou os móveis.

É necessário guardar o talão de compra e indicar o N° do Controlo de Qualidade ao consultar ou reclamar.

### IT

Prodotto nell'U.E. da CIF A-12045134, Indirizzo: Ctra Vinaròs-Ulldecona, km 1 12500 Vinaròs Castellón SPAGNA. 3 anni dalla data di acquisto contra qualsiasi difetto di fabbricazione del prodotto La garanzia non coprende i difetti dovuti al montaggio inadeguato o all'uso improprio dei mobili. Per qualsiasi difetto del mobile o difficoltà durante il montaggio, si prega di contattare il negozio o il sito Web in cui è stato acquistato il mobile.

È necesario conservare il biglietto di acquisto e fornire il N° di Controlo Qualità in fase di consultaciones o reclamo.

N° Control Calidad: \_\_\_\_\_  
Quality Control N°: \_\_\_\_\_  
N° Contrôle Qualité: \_\_\_\_\_  
N° Controlo Qualidade: \_\_\_\_\_  
N° Controllo Qualità: \_\_\_\_\_