

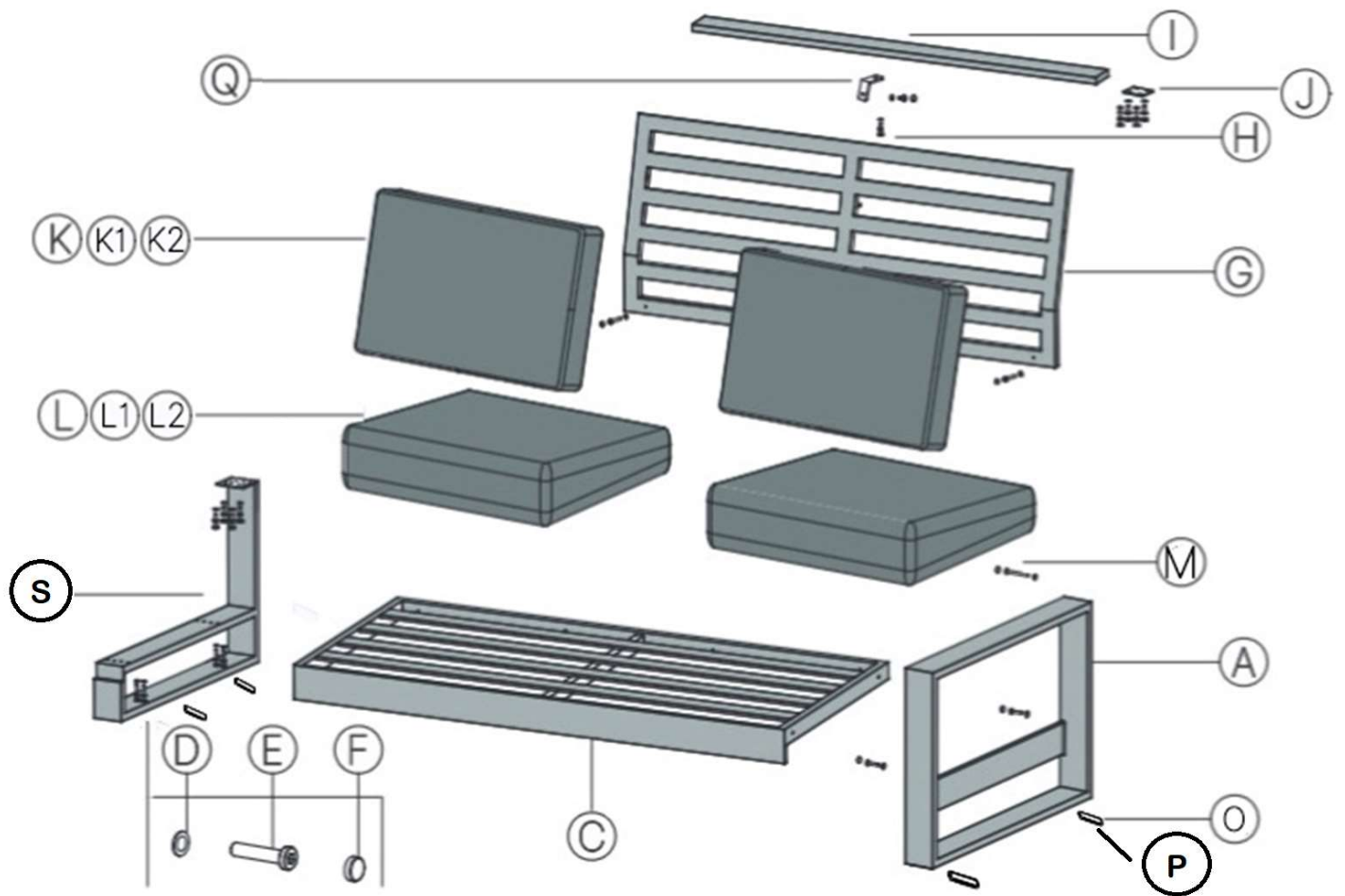





















LEFT SIDE SOFA 2P NATARIAL ATHENA CORNER ALU SPUNPOLYESTER WHITE
3276007600537



Part	Picture	Qty	Spare ref #
A		1	SPP332-0093
C		1	SPP332-0151
D		19	SPP332-0118
E	M6x35 	10	SPP332-0119
F		19	SPP332-0120
G		1	SPP332-0152
H	M6x15 	8	SPP332-0122
I		1	SPP332-0153
J		1	SPP332-0094
K		2	SPP332-0095
K1		2	SPP332-0096
K2		2	SPP332-0097
L		2	SPP332-0098
L1		2	SPP332-0099
L2		2	SPP332-0100
M	M6x60 	1	SPP332-0101
N		1	SPP332-0102
O		4	SPP332-0103
P		8	SPP332-0105
Q		1	SPP332-0154
S		1	SPP332-0169