

EAN : 3276007670530  
Ref : MC-10M-CCT

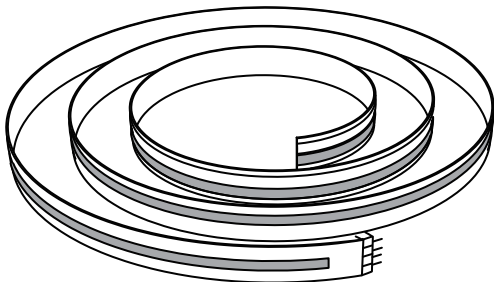

2/2

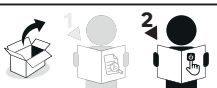

2023-07-V01

**FR** Manuel d'Instructions

**ES** Manual de Instrucciones

**PT** Manual de Instruções

**IT** Manuale di Istruzioni

**EL** Εγχειρίδιο Οδηγιών

**PL** Instrukcja Obsługi

**UA** Інструкція з Експлуатації

**RO** Manual de Instrucțiuni

**BR** Manual de Instrução

**DE** Anleitung Handbuch

**EN** Instructions Manual



FR : Montage / ES: Montaje / PT: Montagem / IT: Montaggio / EL: Συναρμολόγηση /  
PL: Montaż / UA: Збірка / RO: Montaj / BR: Montagem / DE: Montage / EN: Assembly



FR: Utilisation / ES: Utilización / PT: Utilização / IT: Uso / EL: Χρήση / PL: Użytkowanie  
/ UA: Використання / RO: Utilizare / BR: Utilização / DE: Verwenden Sie / EN: Use

FR: CARACTÉRISTIQUES TECHNIQUES / ES: CARACTERÍSTICAS TÉCNICAS / PT: CARACTERÍSTICAS TÉCNICAS /  
IT: CARATTERISTICHE TECNICHE / EL: ΤΕΧΝΙΚΑ ΧΑΡΑΚΤΗΡΙΣΤΙΚΑ / PL: DANE TECHNICZNE / UA: ТЕХНІЧНІ  
ХАРАКТЕРИСТИКИ / RO: CARACTERISTICI TEHNICE / BR: CARACTERÍSTICAS TÉCNICAS / DE: TECHNISCHE  
CHARAKTERISTIKA / EN: TECHNICAL CHARACTERISTICS

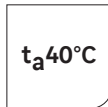
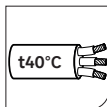
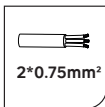

- FR** Ce produit contient une source lumineuse de classe d'efficacité énergétique D.
- ES** Este producto contiene una bombilla de clase de eficiencia D.
- PT** Este produto contém uma fonte de luz de eficiência energética de classe D.
- IT** Questo prodotto contiene una sorgente luminosa di classe di efficienza energetica D.
- EL** Αυτό το προϊόν περιέχει πηγή φωτός κατηγορίας ενεργειακής απόδοσης D.
- PL** Niniejszy produkt zawiera źródło światła klasy efektywności energetycznej D.
- UA** Данне изделие содержит источник света класса энергоэффективности D.
- RO** Acest produs conține o sursă de lumină din clasa de eficiență energetică D.
- DE** Dieses Produkt enthält ein Licht der Energieeffizienzklasse D.
- EN** This product includes a light source of the energy efficiency class D.

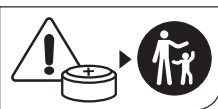
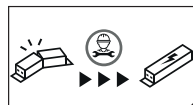
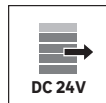
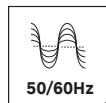
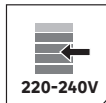
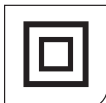
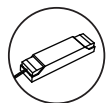
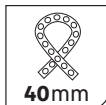
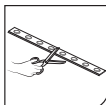
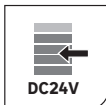

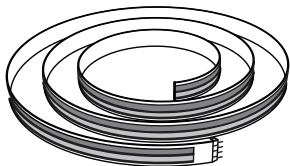

(A) x1

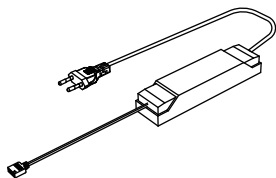

(B) x1

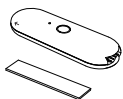

(C) x1

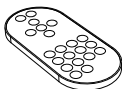

(D) x1

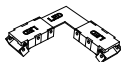

(E) x4



(F) x2



(G) x1

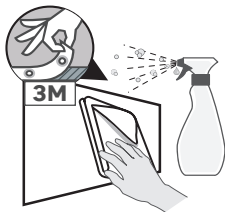



1

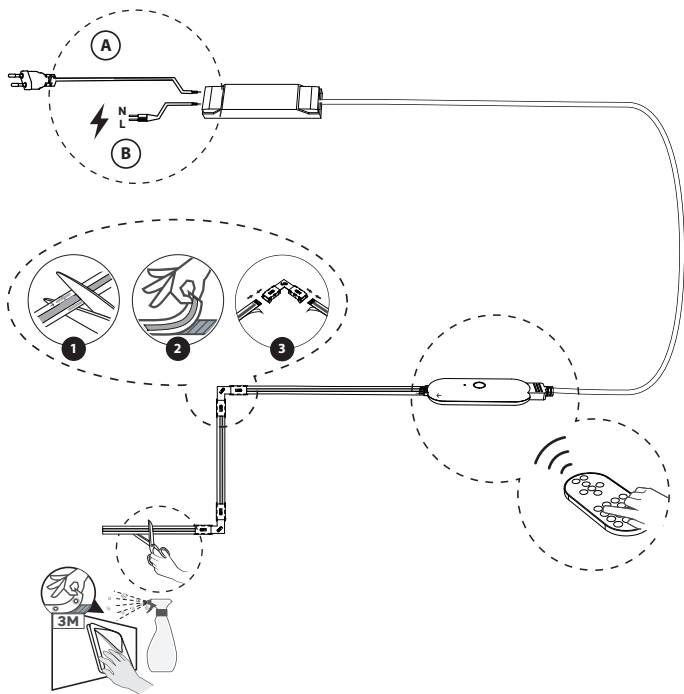



# 2

1

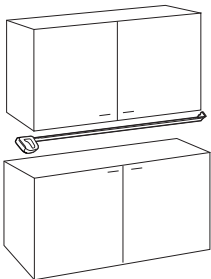

2

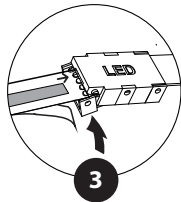
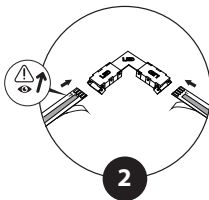
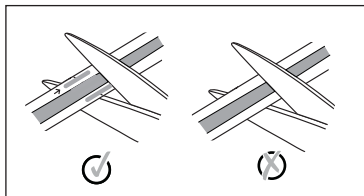
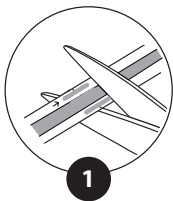
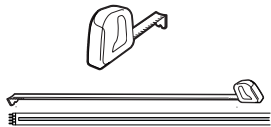

# 3

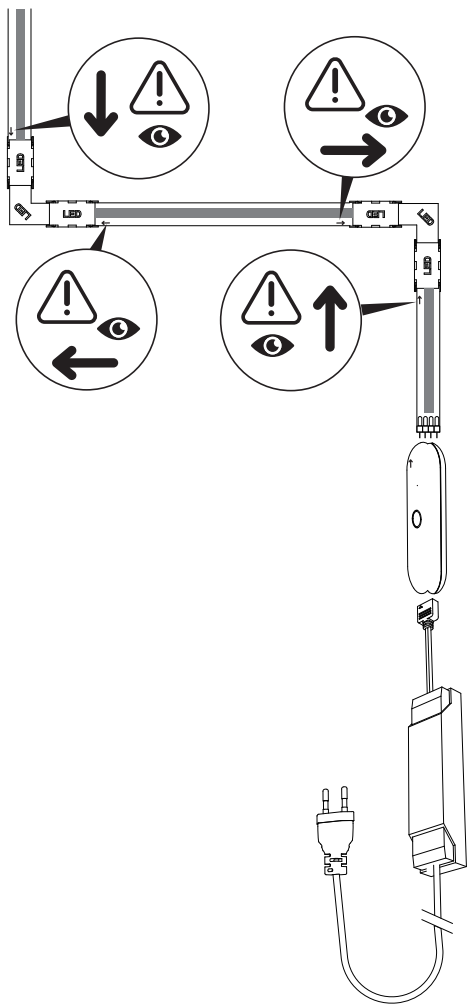

# 4

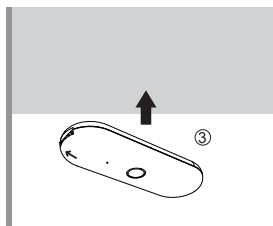
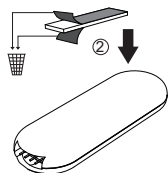
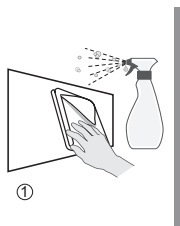

**A**

**B**

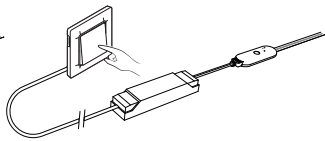
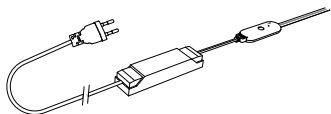

# A

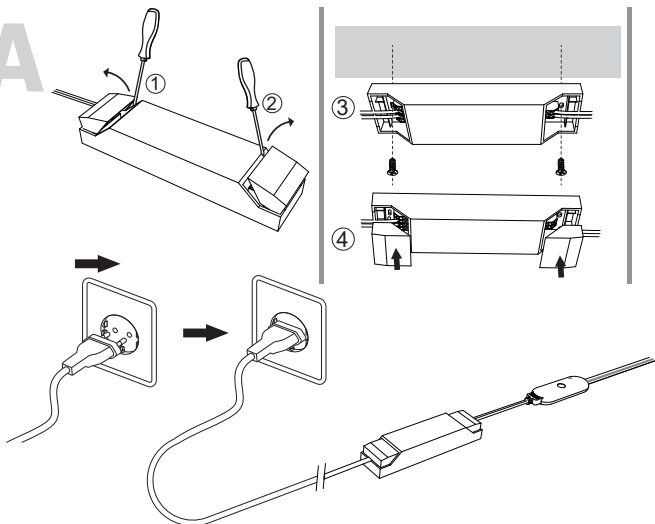

# B

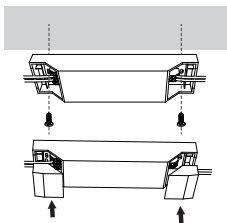
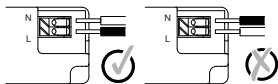
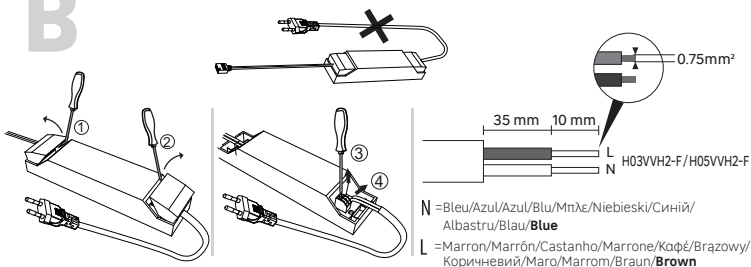



1

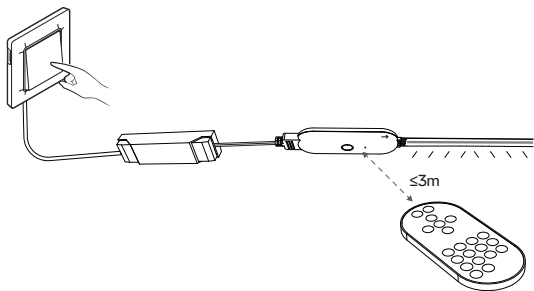
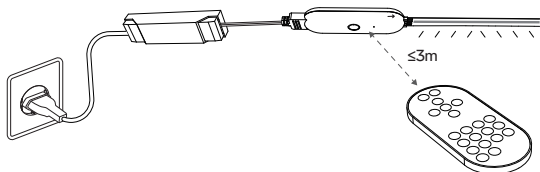

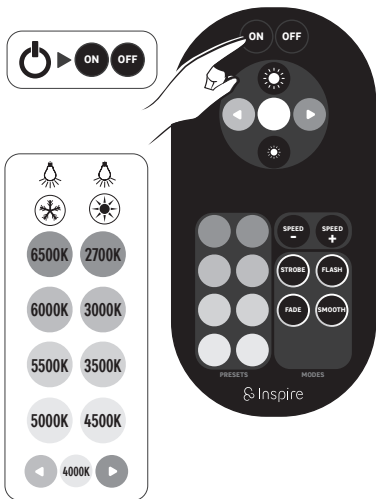
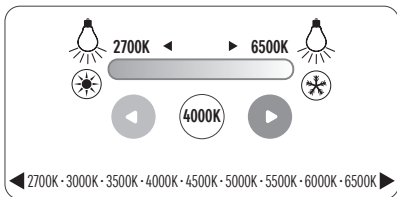
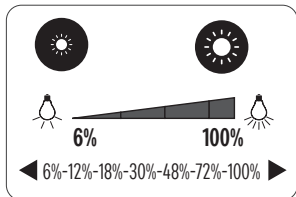

SPEED - SPEED +

Vitesse/Velocidad/Velocidade/  
Velocità/Ταχύτητα/Prędkość/  
Швидкість/Vitezá/Velocidade/  
Geschwindigkeit/Snelheid/Speed

STROBE

Stroboskope/Estroboscópio/  
Estroboscópio/stroboscopio/  
Strobe/stroboskop/стрибає/  
stroboscop/estroboscópio/  
stroboscoop/Blitz/Strobe

FADE

Fondu/Descolorarse/Desvaneça/  
sfumato/ξεθωπιάζει/rozmycie/  
зникати/estompare/afnemen/  
desvanecimento/Verblissen/ Fade

FLASH

clignotant/destello/piscar/  
lampeggiante/λάμψη/Migač/  
cnałax/intermittent/relâmpago  
/flits/Blinken/Flash

SMOOTH

lumière tamisée/luz tamizada/l  
uz difusa/Luce tenue/Λείος/  
gładki/гладкий/amurg/Luz de fundo/  
Glatt/gedempt licht/Smooth

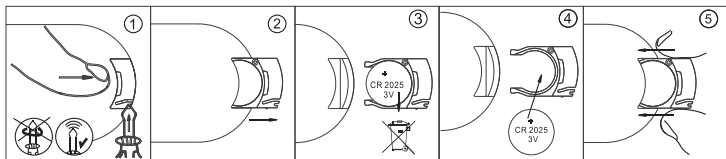



- FR** Ce produit est recyclable. S'il ne peut plus être utilisé, veuillez l'apporter dans un centre de recyclage de déchets.
- ES** Este producto es reciclable. Si ya no se puede usar, llévelo a un centro de reciclaje de residuos.
- PT** Este produto é reciclável. Se deixar de o utilizar, entregue-o num centro de reciclagem de resíduos.
- IT** Questo prodotto può essere riciclato. Se deve essere smaltito, portalo presso un centro di riciclaggio.
- EL** Αυτό το προϊόν είναι ανακυκλώσιμο. Εάν δεν μπορεί πλέον να χρησιμοποιηθεί, μεταφέρετε την σε κάποιο κέντρο ανακύκλωσης απορριμμάτων.
- PL** Ten produkt poddawany jest recyklingowi, kiedy przestaje być użyteczny należy dostarczyć go do punktu zbiórki odpadów.
- UA** Цей продукт може перероблятися. Якщо воно більше не є придатне для використання, здайте його в утилізаційний центр.
- RO** Acest produs este reciclabil. Dacă nu mai poate fi folosit, vă rugăm să îl aduceți într-un centru de reciclare a deșeurilor.
- BR** Este produto é reciclável. Se não puder mais ser usado, descarte em um centro de reciclagem de resíduos.
- DE** Dieses Produkt ist recycelbar. Wenn es nicht mehr verwendet werden kann, bringen Sie es bitte zum Recycling-Center.
- EN** This product is recyclable. If it cannot be used anymore, please take it to waste recycling centre.



FR Traduction de la version originale du mode d'emploi / ES: Traducción de las Instrucciones originales / PT: Tradução das Instruções Originais / IT: Traduzione delle istruzioni originali / EL: Μετάφραση των πρωτότυπων οδηγιών / PL: Tłumaczenie instrukcji oryginalnej / UA: Переклад оригінальної інструкції / RO: Traducerea instrucțiunilor originale / BR: Tradução das Instruções Originais / DE: Übersetzung der Originalversion der Gebrauchsanweisung / Original Instructions.

Made in China

Країна походження: Китай

**EU** ADEO Services - 135 Rue Sadi Carnot - CS00001 - 59790 RONCHIN - FRANCE

**UA** Виробник: ТОВ "Адео Сервісес С.А.", вул. Саді Карно, CS 00001, 59790 Роншен, Франція.  
Імпортер: ТОВ "Леруа Мерлен Україна", 04201 Україна, м. Київ, вул. Полярна 17А, +380 44 498 46 00. Імпортер приймає претензії від споживачів щодо товару, а також проводить його ремонт, технічне і гарантійне обслуговування

**BR** LEROY MERLIN COMPANHIA BRASILEIRA DE BRICOLAGEM  
CNPJ: 01.438.784/0001-05  
Rua Pascoal Pais, nº. 525, 6º andar cj 61 a 64, Vila Cordeiro, São Paulo - SP. CEP: 04581-060  
CALM (Central de Atendimento Leroy Merlin) Capitais  
4020-5376 Demais Regiões 0800-0205376

**ZA** Imported by Adeo South Africa (PTY) LTD T/A Leroy Merlin,  
Hosted in Leroy Merlin Fourways Store 35 Roos Street, Witkoppen  
Ext 97, Sandton, 2191 Johannesburg, Gauteng, South Africa.  
Tel: +27 10 493 8000 Email: contact@leroymerlin.co.za.