

Inspire

CUTFLEXI

EAN : 3276007670769
Ref : SMD-10M-RGBWIC

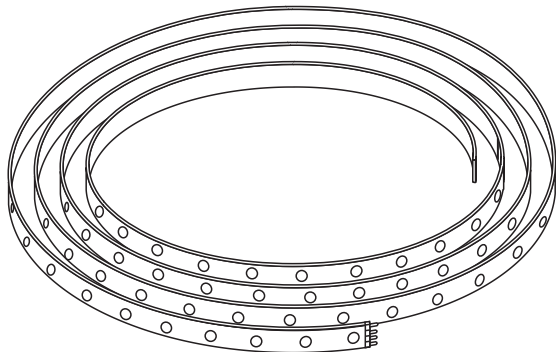

2/2



2023-07-V01

FR Manuel d'Instructions

EL Εγχειρίδιο Οδηγιών

BR Manual de Instrução

ES Manual de Instrucciones

PL Instrukcja Obsługi

DE Anleitung Handbuch

PT Manual de Instruções

UA Інструкція з Експлуатації

EN Instructions Manual

IT Manuale di Istruzioni

RO Manual de Instrucțiuni

*Année de garantie / años de garantía / Ano de garantia / Anno di garanzia / Έτος εγγύησης / Rok gwarancji / Гарантія років / Anul de garanție / Anos de garantía / Jahr der Garantie / Year of guarantee

** réparable / reparabile / reparável / riparabile / διορθώσιμος / naprawiany / ремонтний / reparabil / reparaturfähig / reparável / repairable



FR : Montage / ES: Montaje / PT: Montagem / IT: Montaggio / EL: Συναρμολόγηση /
PL: Montaż / UA: Збірка / RO: Montaj / BR: Montagem / DE: Montage / EN: Assembly



FR: Utilisation / ES: Utilización / PT: Utilização / IT: Uso / EL: Χρήση / PL: Użytkowanie
/ UA: Використання / RO: Utilizare / BR: Utilização / DE: Verwenden Sie / EN: Use

FR: CARACTÉRISTIQUES TECHNIQUES / ES: CARACTERÍSTICAS TÉCNICAS / PT: CARACTERÍSTICAS TÉCNICAS /
IT: CARATTERISTICHE TECNICHE / EL: ΤΕΧΝΙΚΑ ΧΑΡΑΚΤΗΡΙΣΤΙΚΑ / PL: DANE TECHNICZNE / UA: ΤΕΧΝΙΚΗ
ΧΑΡΑΚΤΗΡΙΣΤΙΚΑ / RO: CARACTERISTICI TEHNICE / BR: CARACTERÍSTICAS TÉCNICAS / DE: TECHNISCHE
CHARAKTERISTIKA / EN: TECHNICAL CHARACTERISTICS



1 / 2

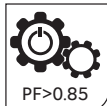
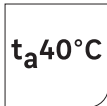
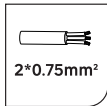

- FR** Ce produit contient une source lumineuse de classe d'efficacité énergétique D.
- ES** Este producto contiene una bombilla de clase de eficiencia D.
- PT** Este produto contém uma fonte de luz de eficiência energética de classe D.
- IT** Questo prodotto contiene una sorgente luminosa di classe di efficienza energetica D.
- EL** Αυτό το προϊόν περιέχει πηγή φωτός κατηγορίας ενεργειακής απόδοσης D.
- PL** Niniejszy produkt zawiera źródło światła klasy efektywności energetycznej D.
- UA** Дане изделие содержит источник света класса энергоэффективности D.
- RO** Acest produs conține o sursă de lumină din clasa de eficiență energetică D.
- DE** Dieses Produkt enthält ein Licht der Energieeffizienzklasse D.
- EN** This product includes a light source of the energy efficiency class D.

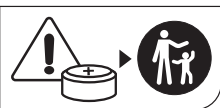
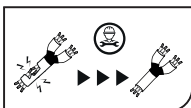
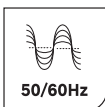
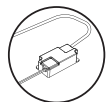
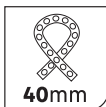
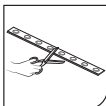

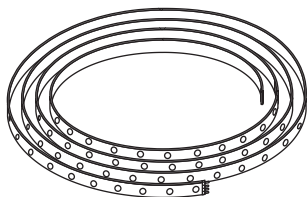

(A) x1

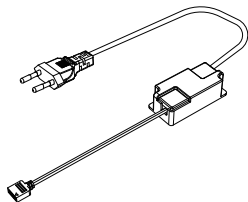

(B) x1

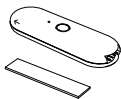

(C) x1

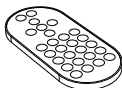

(D) x1

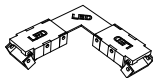

(E) x4



(F) x2



(G) x1

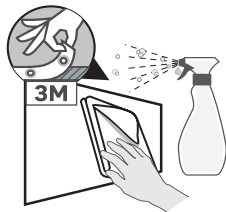
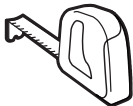

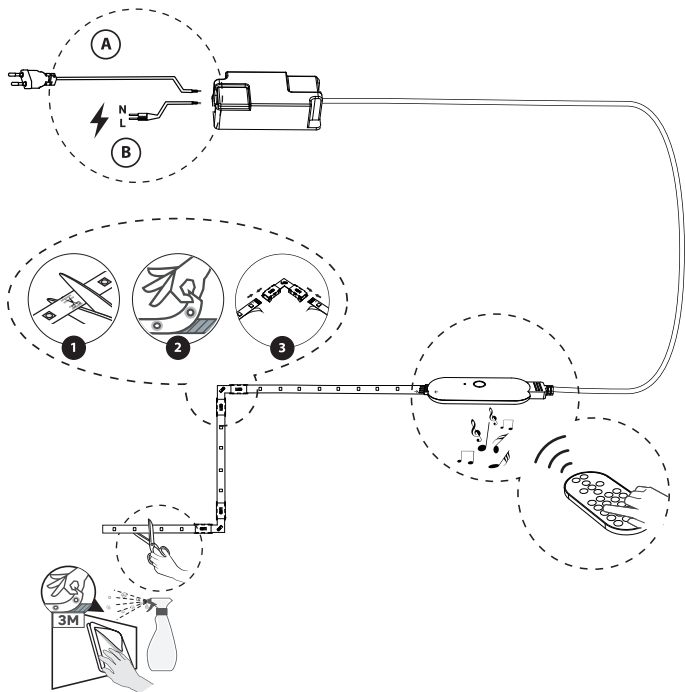



1

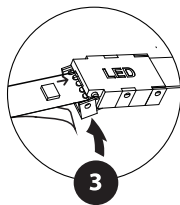
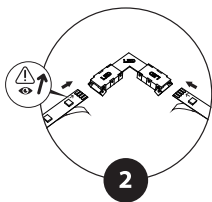
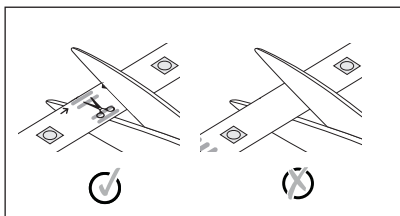
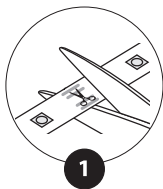
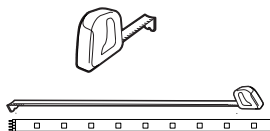
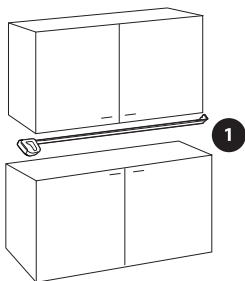

2

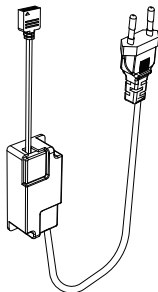
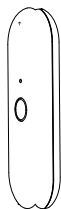
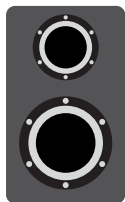
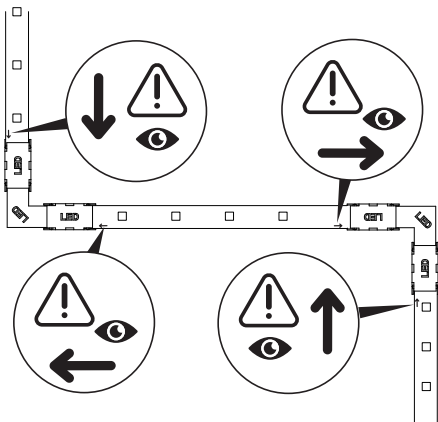

3

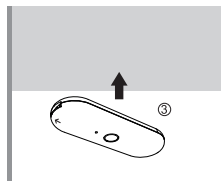
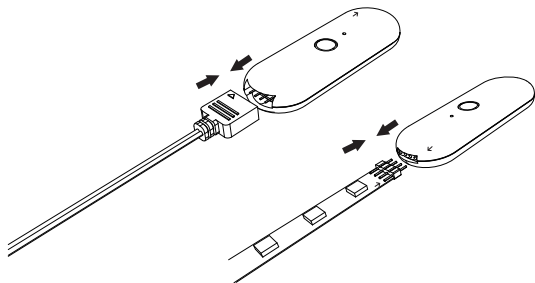

A

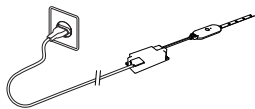

B

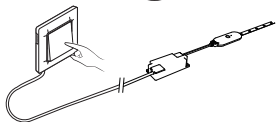

A

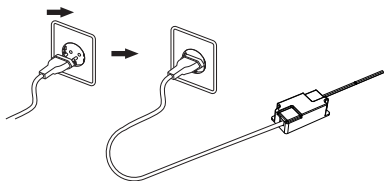

B

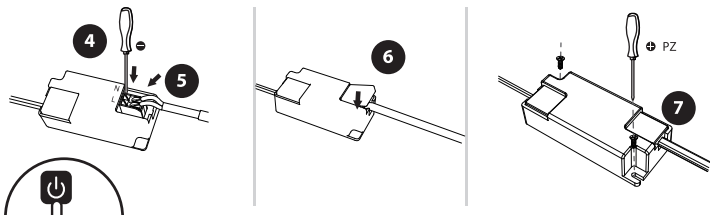
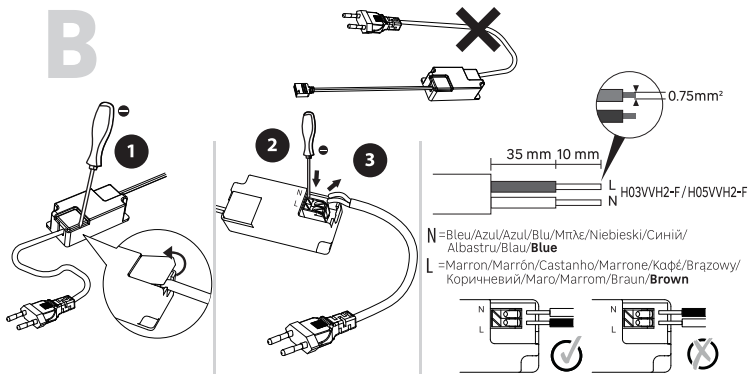

1

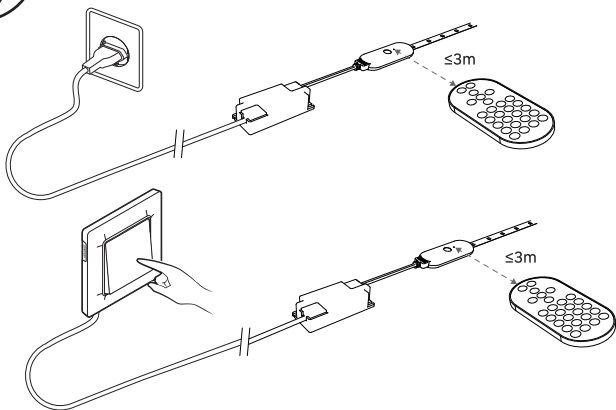



Sélecteur de couleurs /Selector de colores/
Seletor de cores/Selettore di colori/
Επιλογέας χρωμάτων/Selektor kolorów/
Селектор кольорів/Selector de colori/
Seletor de cores/Farbauswahl/Kleurkiezer/
Color selector

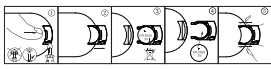
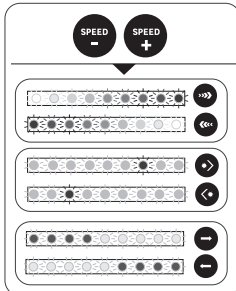
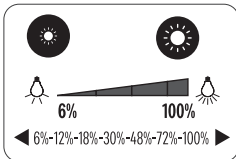

1

2

SPEED

-

SPEED

+

Vitesse/Velocidad/Velocidade/
Velocità/Ταχύτητα/Prędkość/
Швидкість/Vitezà/Velocidade/
Geschwindigkeit/Snelheid/Speed

FLASH

Clignotant/destello/piscar/
lampeggiante/λάμψη/Migač/
снапах/intermittent/relâmpago
/flits/Blinken/Flash

FADE

Fondu/Descolorarse/Desvanecer/
sfumato/ξεθωριάζει/rozmycie/
зникати/estompare/afnemen/
desvanecimento/Verblissen/ Fade

STROBE

Stroboscope/Estroboscópio/
Estroboscópio/stroboscopio/
Strobe/stroboskop/стрибас/
stroboscop/estroboscópio/
stroboscoop /Blitz/Strobe

SMOOTH

Lumière tamisée/Luz tamizada/l
uz difuza/Luce tenue/Λειος/
gładki/гладкий/amurg/Luz de fundo/
Glatt/Gedempt licht/Smooth

METEOR

Méteor/Meteorito/Meteora/
Meteora/Μετεωρίτης/Meteoryt/
Meteor/Meteor/Meteora/
Meteor/Meteoor/Meteor

JUMP

Sauter/Saltar/Pular/
Saltare/Πηδήξε/Skok/
Прыгать/Секіры/Стрибати/
Sári/Pular/Springen/Springen/Jump

STACK

Empiler/Apilar/Empilhar/
Impilare/Στοιβαξη/Stosować/
Стек/À empila/Empilhar/
Stapeln/Stapelen/Stack

MUSIC

Réagit à la musique/Intermittente
musical/Pisca musical/Lampeggiante
musicale/Μουσικό αναβοσβήνον/
Migający muzyczny/
Музичний миготливий/Intermittent
muzical/Pisca musical/Musikalischer
Blinker/Muzikaal knipperlicht/
Musical blinker

FR: «Choisissez une configuration et appuyez 3 secondes jusqu'au flash pour mémoriser.»

ES: «Elige una configuración y mantén presionado durante 3 segundos hasta que parpadee para memorizar.»

PT: «Escolha uma configuração e pressione por 3 segundos até piscar para memorizar.»

IT: «Scegli una configurazione e premi per 3 secondi fino al lampeggio per memorizzare.»

EL: «Επιλέξτε μια ρύθμιση και πατήστε για 3 δευτερόλεπτα μέχρι να αναβοσβήσει για να αποθηκεύσει.»

PL: «Wybierz konfigurację i przytrzymaj przez 3 sekundy, aż zaświeci się, aby zapamiętać.»

UK: «Оберіть налаштування і утримуйте протягом 3 секунд до миготіння для запам'ятовування.»

RO: «Alegeți o configurație și apăsați timp de 3 secunde până la flash pentru a memora.»

BR: «Escolha uma configuração e pressione por 3 segundos até piscar para memorizar.»

DE: «Wählen Sie eine Konfiguration aus und halten Sie sie 3 Sekunden lang gedrückt, bis sie aufleuchtet, um sie zu speichern.»

NL: «Kies een configuratie en houd 3 seconden ingedrukt tot het knippert om te onthouden.»

EN: «Choose a configuration and press for 3 seconds until it flashes to memorize.»



- FR** Ce produit est recyclable. S'il ne peut plus être utilisé, veuillez l'apporter dans un centre de recyclage de déchets.
- ES** Este producto es reciclable. Si ya no se puede usar, llévelo a un centro de reciclaje de residuos.
- PT** Este produto é reciclável. Se deixar de o utilizar, entregue-o num centro de reciclagem de resíduos.
- IT** Questo prodotto può essere riciclato. Se deve essere smaltito, portalo presso un centro di riciclaggio.
- EL** Αυτό το προϊόν είναι ανακυκλώσιμο. Εάν δεν μπορεί πλέον να χρησιμοποιηθεί, μεταφέρετε την σε κάποιο κέντρο ανακύκλωσης απορριμμάτων.
- PL** Ten produkt poddawany jest recyklingowi, kiedy przestaje być użyteczny należy dostarczyć go do punktu zbiórki odpadów.
- UA** Цей продукт може перероблятися. Якщо воно більше не є придатне для використання, здайте його в утилізаційний центр.
- RO** Acest produs este reciclabil. Dacă nu mai poate fi folosit, vă rugăm să îl aduceți într-un centru de reciclare a deșeurilor.
- BR** Este produto é reciclável. Se não puder mais ser usado, descarte em um centro de reciclagem de resíduos.
- DE** Dieses Produkt ist recycelbar. Wenn es nicht mehr verwendet werden kann, bringen Sie es bitte zum Recycling-Center.
- EN** This product is recyclable. If it cannot be used anymore, please take it to waste recycling centre.



FR: Traduction de la version originale du mode d'emploi / ES: Traducción de las Instrucciones originales / PT: Tradução das Instruções Originais / IT: Traduzione delle istruzioni originali / EL: Μετάφραση των πρωτότυπων οδηγιών / PL: Tłumaczenie instrukcji oryginalnej / UA: Переклад оригінальної інструкції / RO: Traducerea instrucțiunii originale / BR: Tradução das Instruções Originais / DE: Übersetzung der Originalversion der Gebrauchsanweisung / Original Instructions.

Made in China

Країна походження: Китай

EU ADEO Services - 135 Rue Sadi Carnot - CS00001 - 59790 RONCHIN - FRANCE

UA Виробник: ТОВ "Адео Сервісес С.А.", вул. Саді Карно, CS 00001, 59790 Роншен, Франція.
Імпортер: ТОВ "Леруа Мерлен Україна", 04201 Україна, м. Київ, вул. Полярна 17А, +380 44 498 46 00. Імпортер приймає претензії від споживачів щодо товару, а також проводить його ремонт, технічне і гарантійне обслуговування

BR LEROY MERLIN COMPANHIA BRASILEIRA DE BRICOLAGEM
CNPJ: 01.438.784/0001-05
Rua Pascoal Pais, nº. 525, 6º andar cj 61 a 64, Vila Cordeiro, São Paulo - SP. CEP: 04581-060
CALM (Central de Atendimento Leroy Merlin) Capitais 4020-5376 Demais Regiões 0800-0205376

ZA Imported by Adeo South Africa (PTY) LTD T/A Leroy Merlin, Hosted in Leroy Merlin Fourways Store 35 Roos Street, Witkoppen Ext 97, Sandton, 2191 Johannesburg, Gauteng, South Africa.
Tel: +27 10 493 8000 Email: contact@leroymerlin.co.za.