

EAN : 3276007681567  
Ref: FURTUNABL21FSC

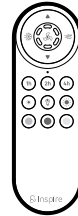

2/2

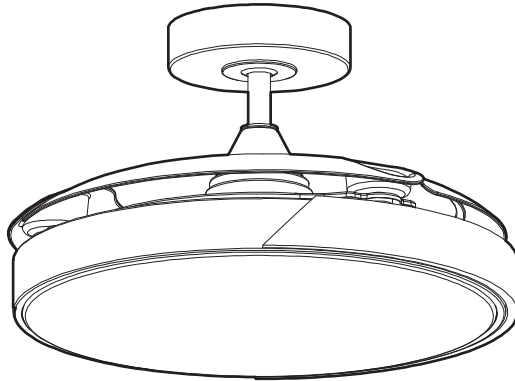

2023-07-V01

**FR** Manuel d'Instructions

**EL** Εγχειρίδιο Οδηγών

**BR** Manual de Instrução

**ES** Manual de Instrucciones

**PL** Instrukcja Obsługi

**DE** Anleitung Handbuch

**PT** Manual de Instruções

**UA** Інструкція з Експлуатації

**EN** Instructions Manual

**IT** Manuale di Istruzioni

**RO** Manual de Instrucțiuni





FR: Montage / ES: Montaje / PT: Montagem / IT: Montaggio / EL: Συναρμολόγηση /  
 PL: Montaż / UA: Збірка / RO: Montaj / BR: Montagem / DE: Montage / EN: Assembly







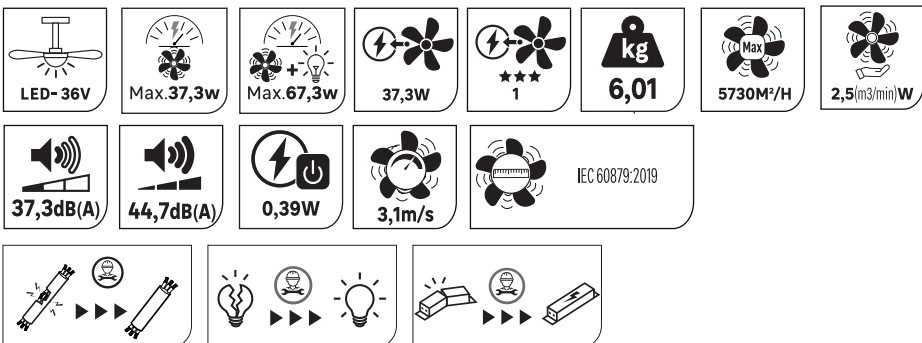
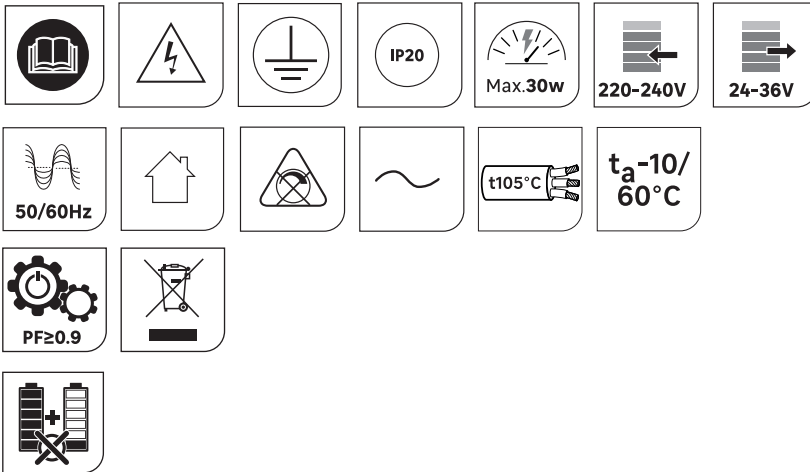

FR: Utilisation / ES: Utilización / PT: Utilização / IT: Uso / EL: Χρήση / PL: Użytkowanie  
 / UA: Використання / RO: Utilizare / BR: Utilização / DE: Verwenden Sie / EN: Use

**FR: CARACTÉRISTIQUES TECHNIQUES / ES: CARACTERÍSTICAS TÉCNICAS / PT: CARACTERÍSTICAS TÉCNICAS / IT: CARATTERISTICHE TECNICHE / EL: ΤΕΧΝΙΚΑ ΧΑΡΑΚΤΗΡΙΣΤΙΚΑ / PL: DANE TECHNICZNE / UA: ТЕХНІЧНІ ХАРАКТЕРИСТИКИ / RO: CARACTERISTICI TEHNICE / BR: CARACTERÍSTICAS TÉCNICAS / DE: TECHNISCHE CHARAKTERISTIKA / EN: TECHNICAL CHARACTERISTICS**



- FR Ce produit contient une source lumineuse de classe d'efficacité énergétique D.
- ES Este producto contiene una bombilla de clase de eficiencia D.
- PT Este produto contém uma fonte de luz de eficiência energética de classe D.
- IT Questo prodotto contiene una sorgente luminosa di classe di efficienza energetica D.
- EL Αυτό το προϊόν περιέχει πηγή φωτός κατηγορίας ενεργειακής απόδοσης D.
- PL Niniejszy produkt zawiera źródło światła klasy efektywności energetycznej D.
- UA Данное изделие содержит источник света класса энергоэффективности D.
- RO Acest produs conține o sursă de lumină din clasa de eficiență energetică D.
- DE Dieses Produkt enthält ein Licht der Energieeffizienzklasse D.
- EN This product includes a light of the energy efficiency class D.

(EU) 2019-2015

	<b>1</b>	<b>2</b>	<b>3</b>	<b>4</b>	<b>5</b>	<b>6</b>
 W	6,2	9,7	14	20,1	28,8	37,3
 RPM	121	138	153	173	196	208
 m3/H	2620	3480	3910	4500	5110	5730
 m3/min/W	7,0	6,0	4,6	3,7	2,9	2,5
 XXdB	37,3	38,1	39,7	40,8	43,4	44,7



**A**

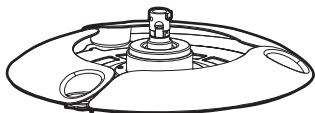

**F**



**L**

x5

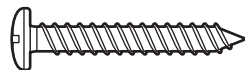

**B**

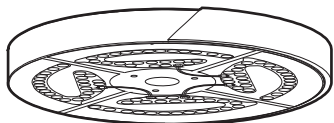

**G**



**M**

x5

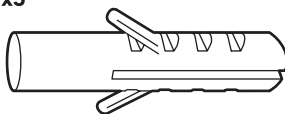

**C**



**H**



**N**

x2

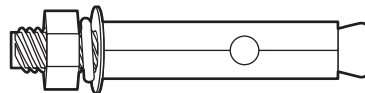

**D**



**I**



**O**



**E**

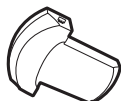

**J**



**P**

x2



**K**

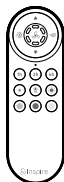

**Q**

x2



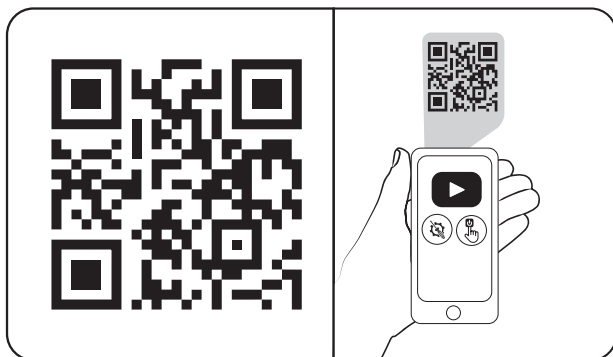

**FR** : Scanner ce code QR pour voir la vidéo de montage

**ES** : Escanear este código QR para ver el video de montaje

**PT** : Digitalize este código QR para ver o vídeo de montagem

**IT** : Scannerizza questo codice QR per vedere il video di montaggio

**EL** : Σαρώστε τον συγκεκριμένο κωδικό QR για να δείτε το βίντεο συναρμολόγησης

**PL** : Zeskanuj ten kod QR, aby zobaczyć wideo montażowe

**UA** : Відскануйте цей QR-код, щоб переглянути відео про монтаж

**RO** : Scanați acest cod QR pentru a viziona videoclipul de montaj

**BR** : Escanear este código QR para ver o vídeo de montagem

**NL** : Scan deze QR-code om de montagevideo te bekijken

**DE** : Scannen Sie diesen QR-Code, um das Montagevideo anzusehen

**EN** : Scan this QR code to view the assembly video



Ø 6mm

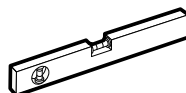
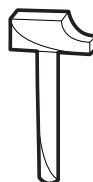

+

PZ



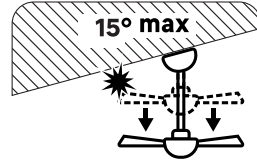
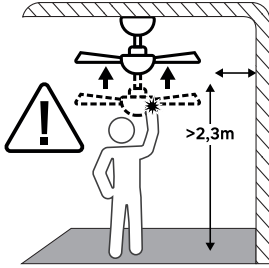
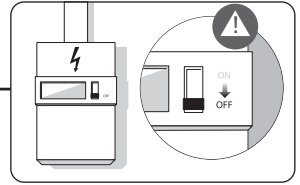
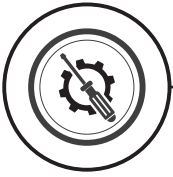

**A**

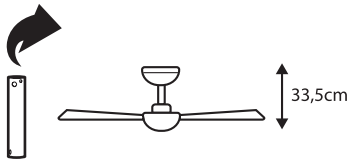

**B**

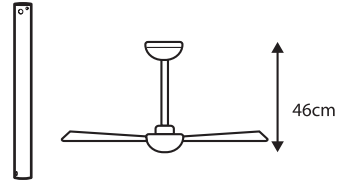

1

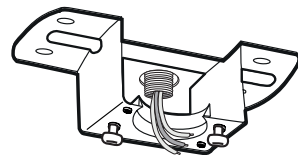
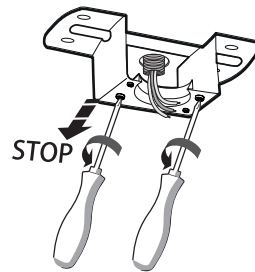
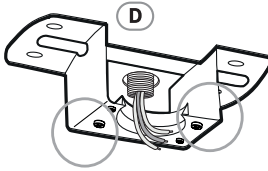

# 2

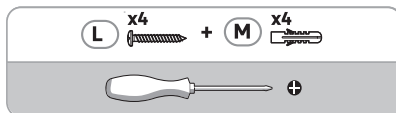
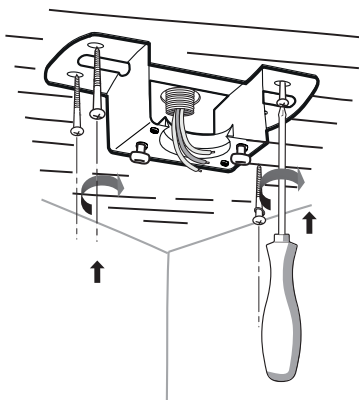

OR

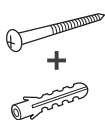
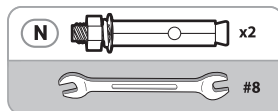
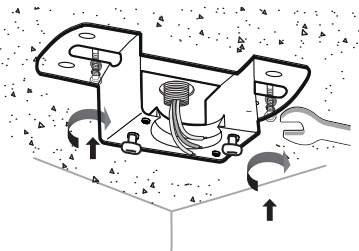

Utiliser des vis et des chevilles adaptées à votre support / Utilice tacos y tornillos adecuados al soporte / Utilize buchas e parafusos adequado ao seu suporte / Utilizzare viti e tasselli adatti per il retro / Χρησιμοποιήστε βίδες και βύσματα που ταιριάζουν στην επιφάνεια στήριξης. / Należy użyć śrub i kotków odpowiednich dla podłoża / Використовуйте гвинти та шканти, призначені для задньої поверхні. / Utilizați șuruburi și dibluri adecvate pentru suportul dvs. / Use parafusos e buchas adequados para seu suporte / Verwenden Sie für Ihre Unterlage geeignete Schrauben und Dübel / Use screws and dowels suited to your backing

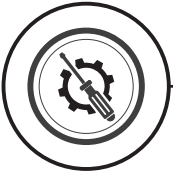

1

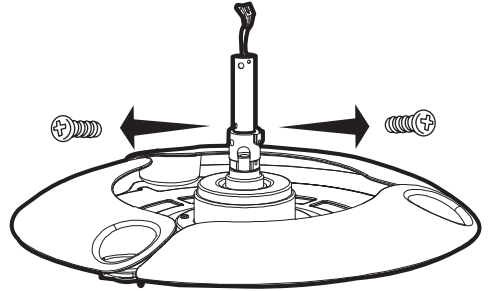
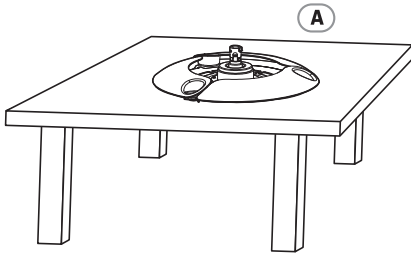

2

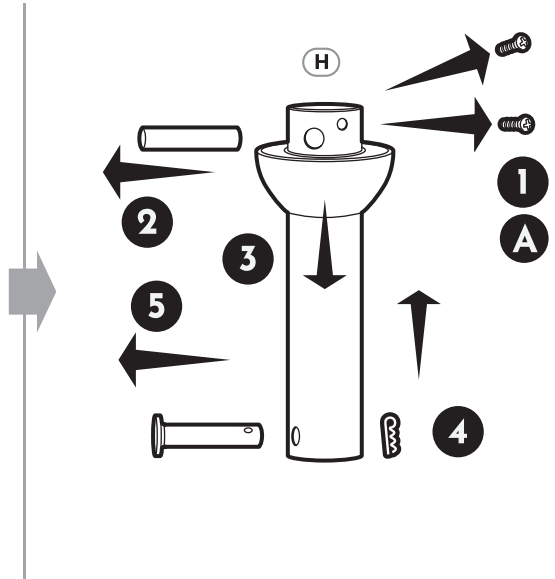
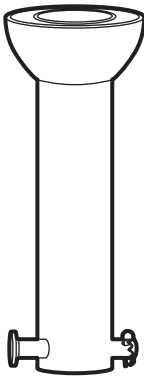

# 3

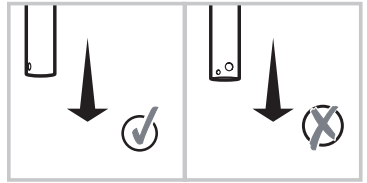

OR

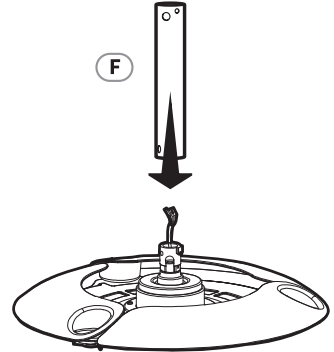
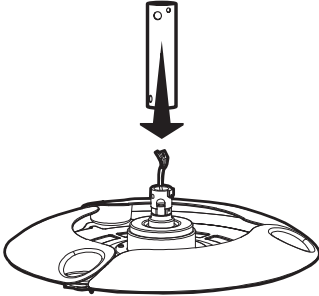

# 4

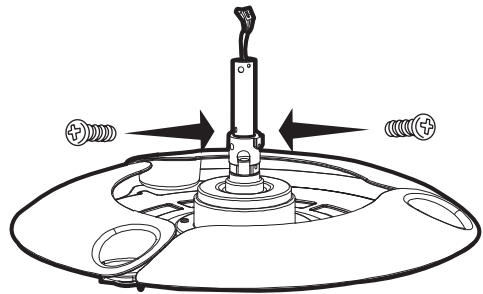
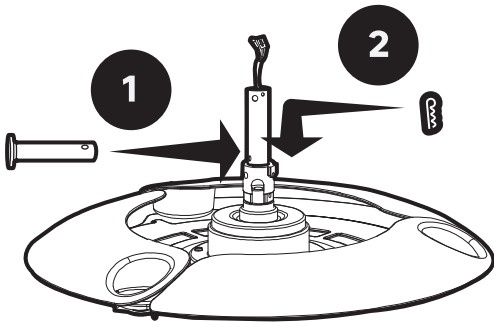

# 5

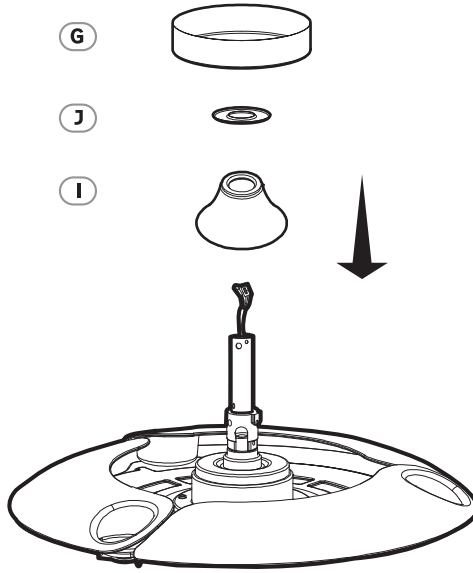

# 6

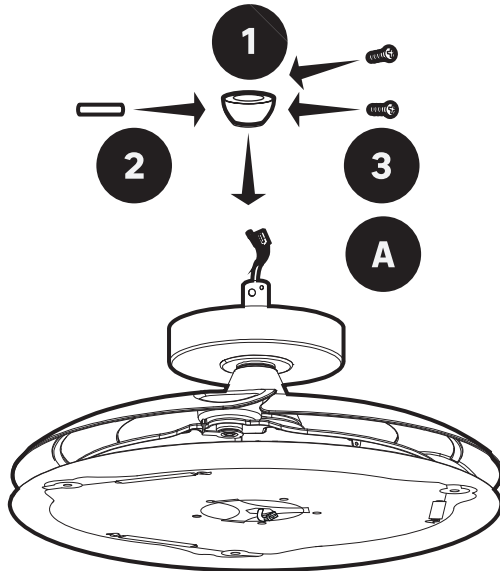

# 7

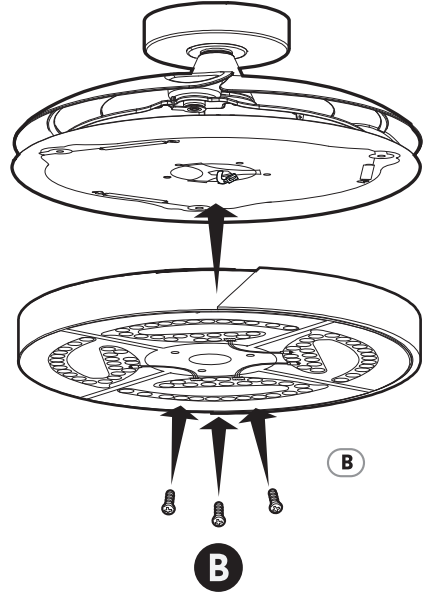
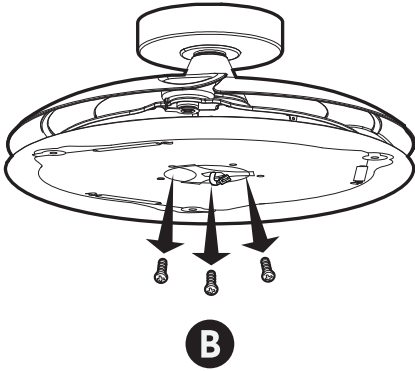

# 8

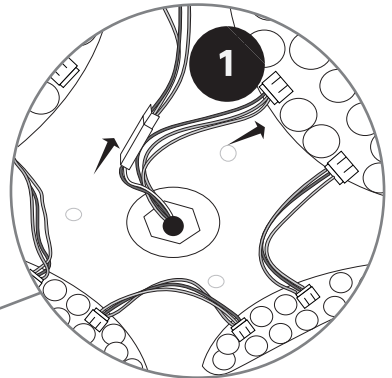
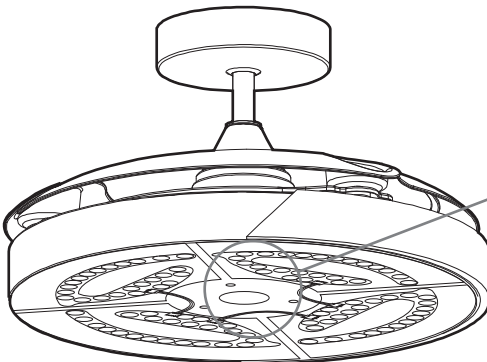

# 9

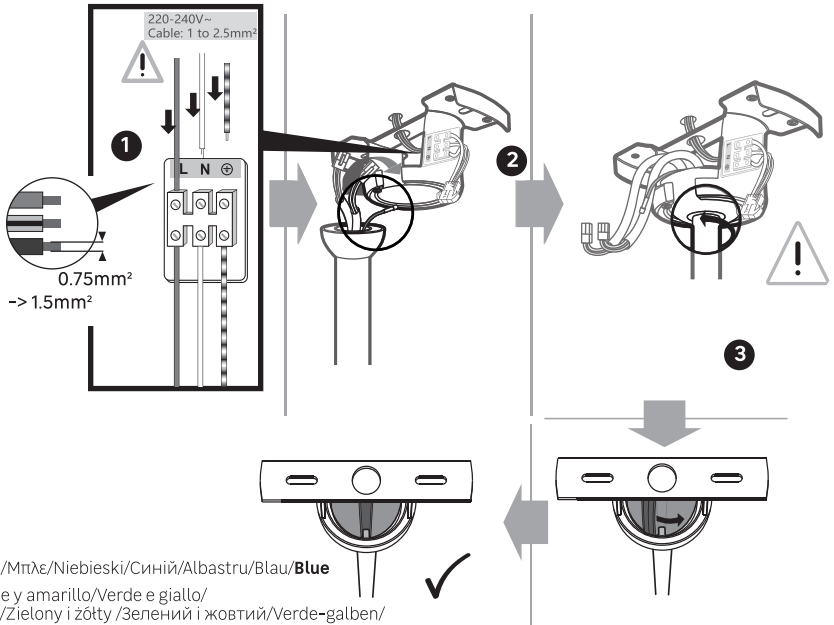

N =Bleu/Azul/Azul/Blu/Μπλε/Niebieski/Синій/Albastru/Blau/**Blue**

⊕ =Vert et jaune/Verde e amarillo/Verde e giallo/  
Πράσινο και κίτρινο / Zielony i żółty / Зелений і жовтий/Verde-galben/  
Verde e amarelo/Grün und gelb/**Green and yellow**

L =Marron/Marrón/Castanho/Marrone/Κοφέ/Brazowy/  
Коричневий/Μαρο/Marrom/Braun/**Brown**

# 10

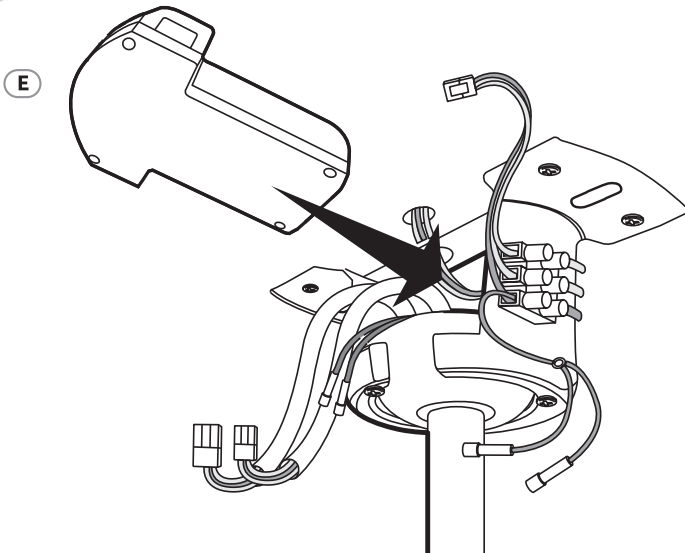

# 11

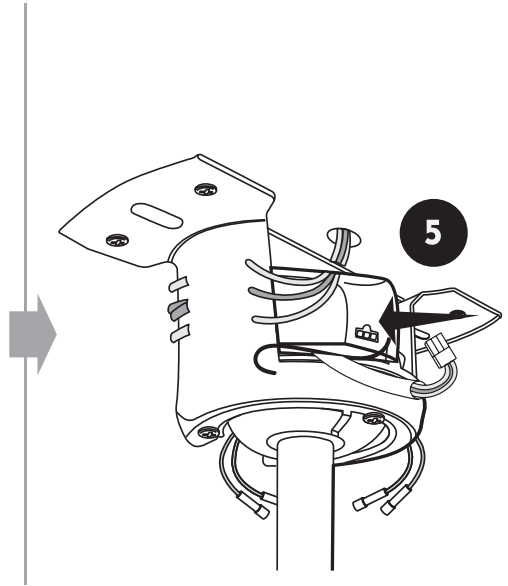
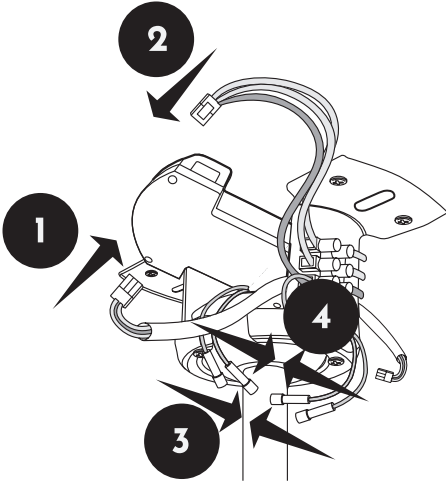
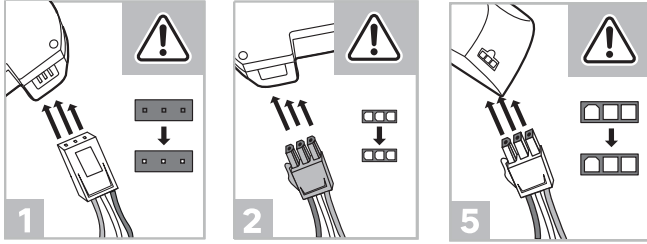

12

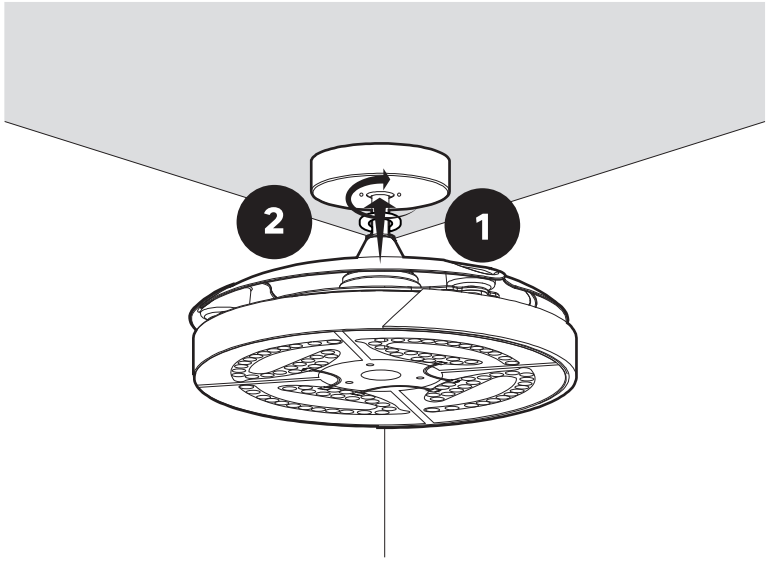

13

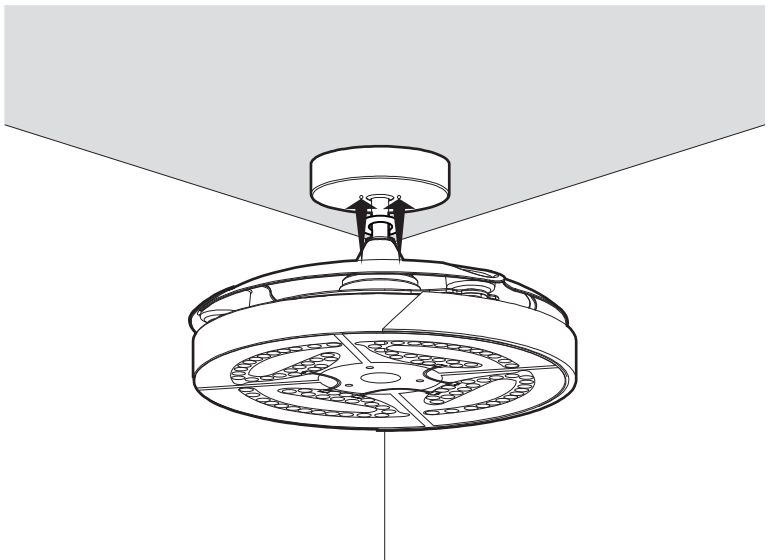

14

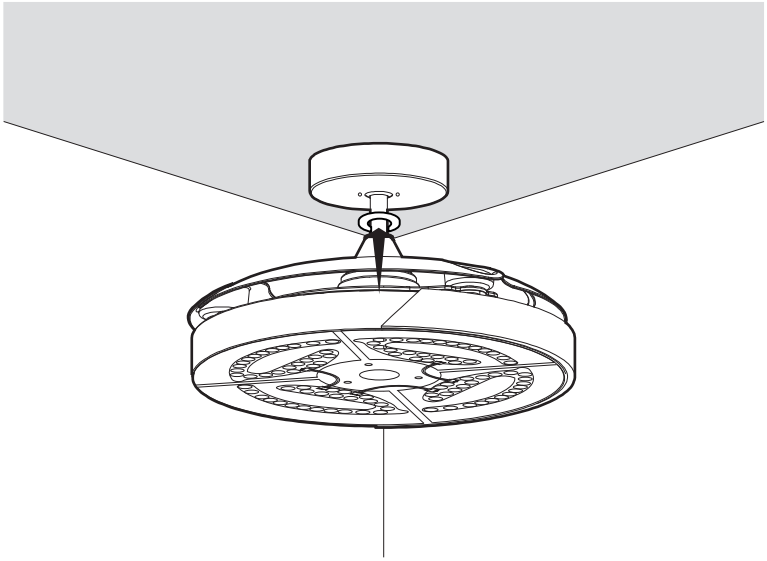

15

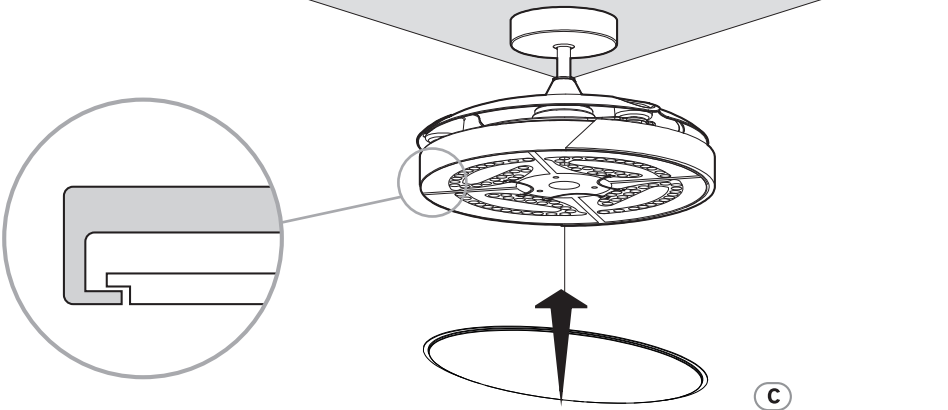

16

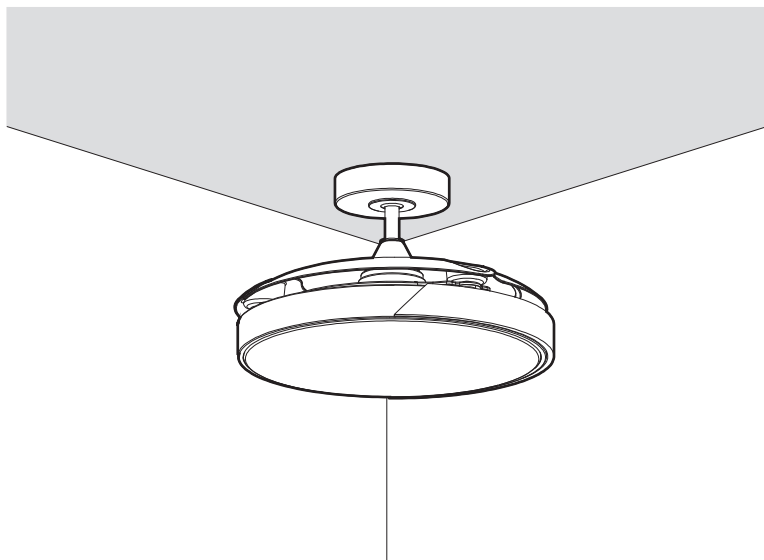

17

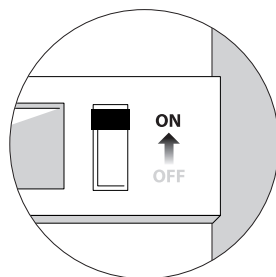
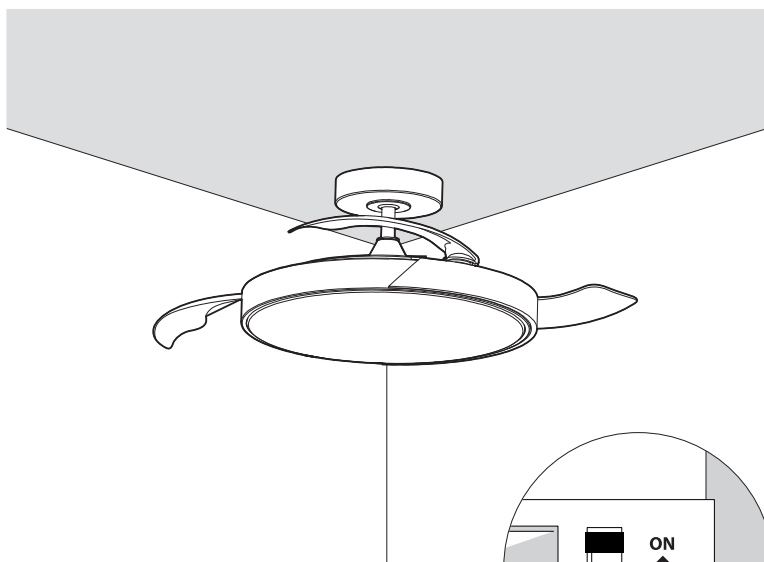



A

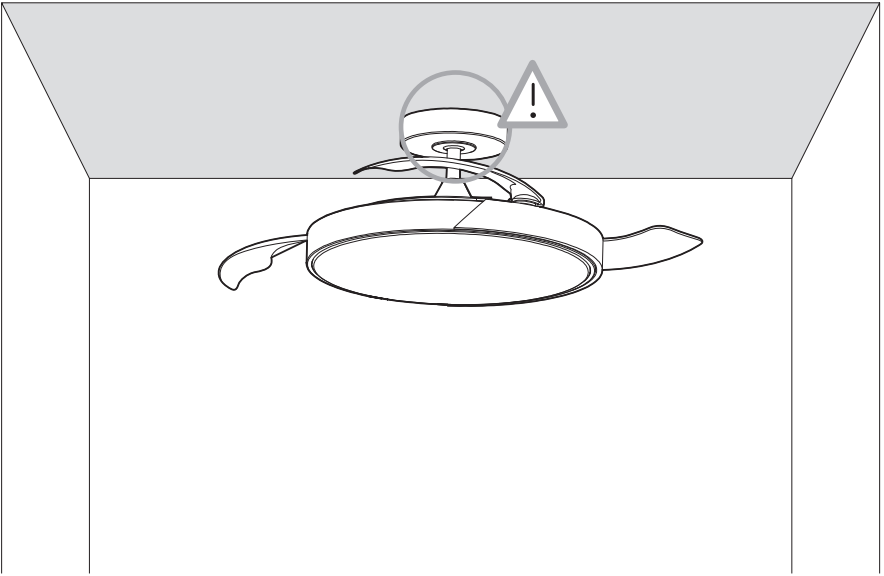

# B



max. 10°

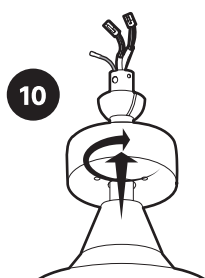
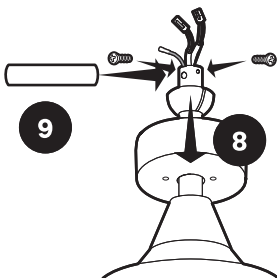
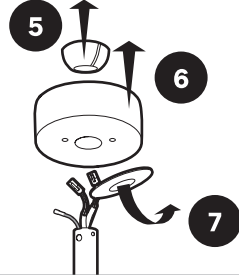
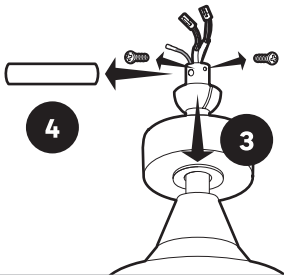
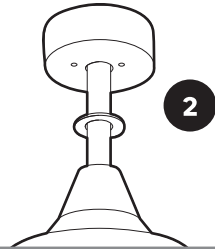
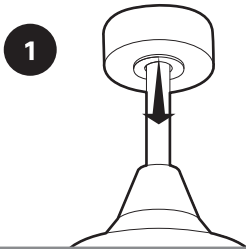
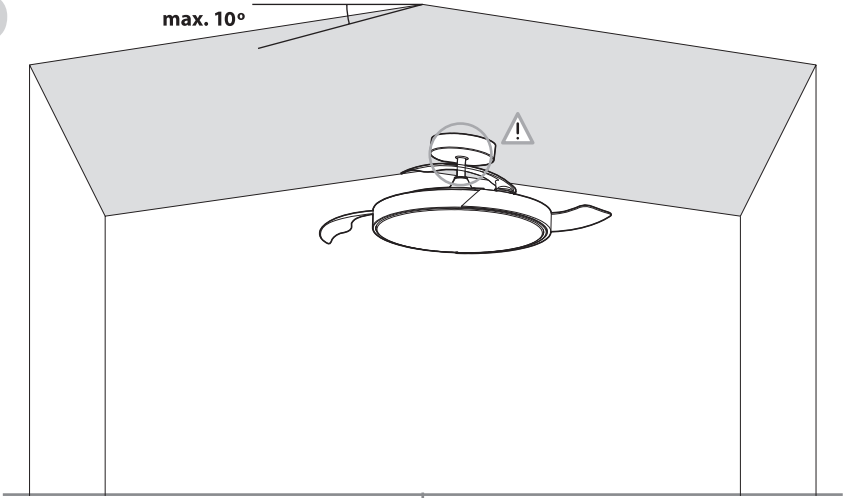

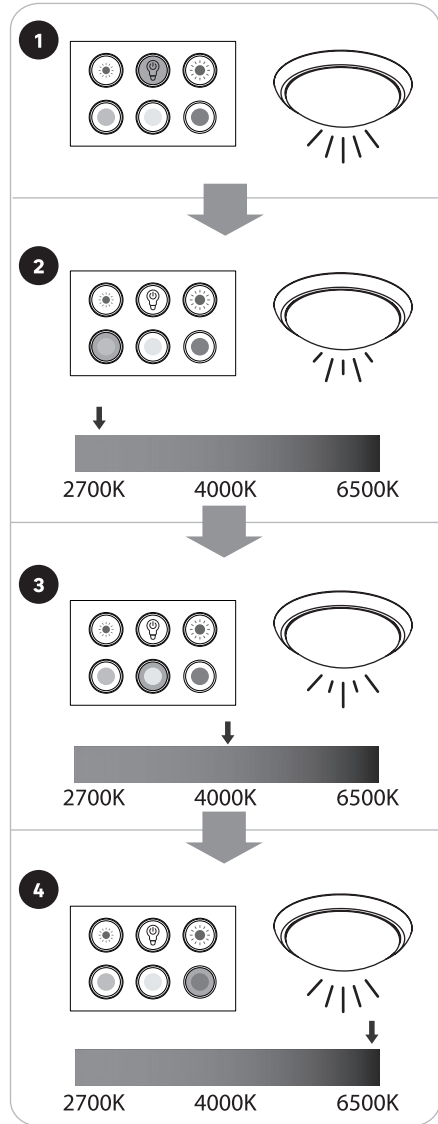
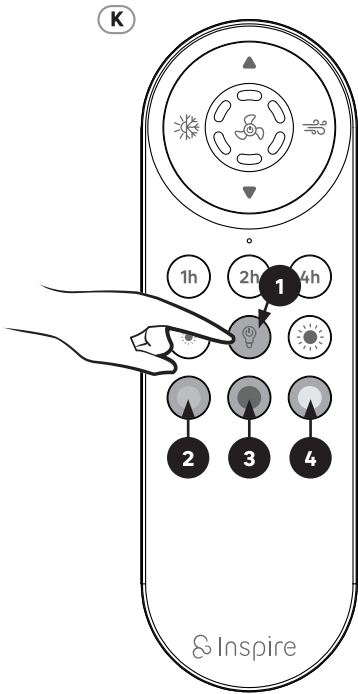
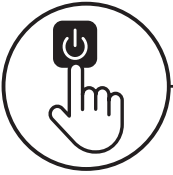

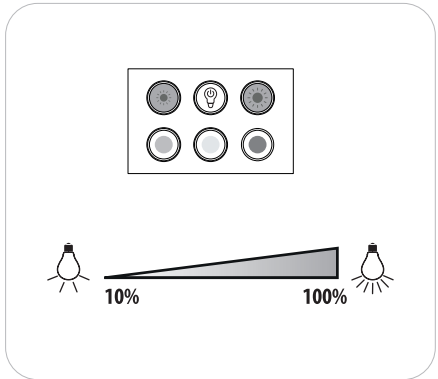
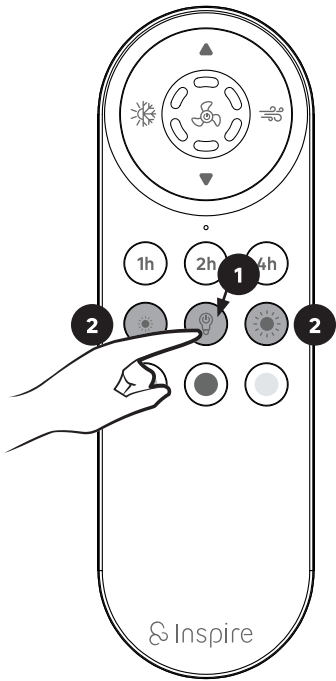

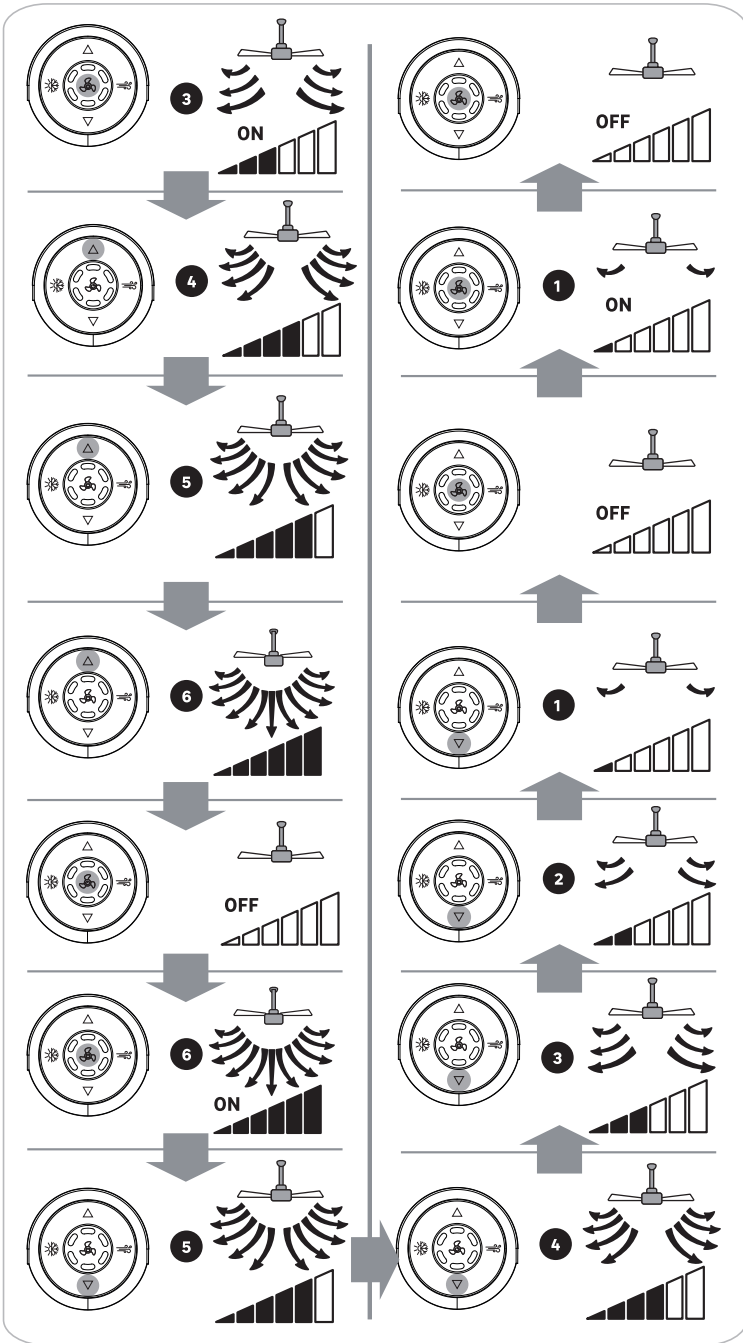
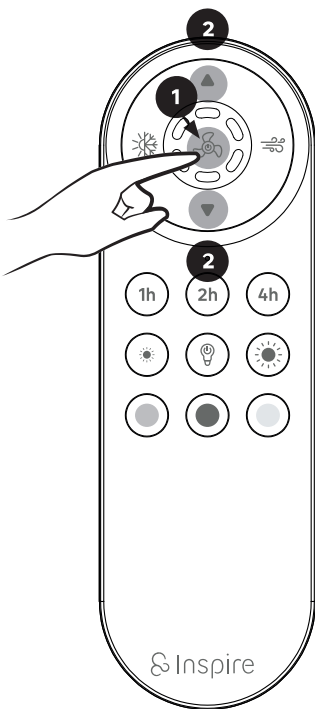

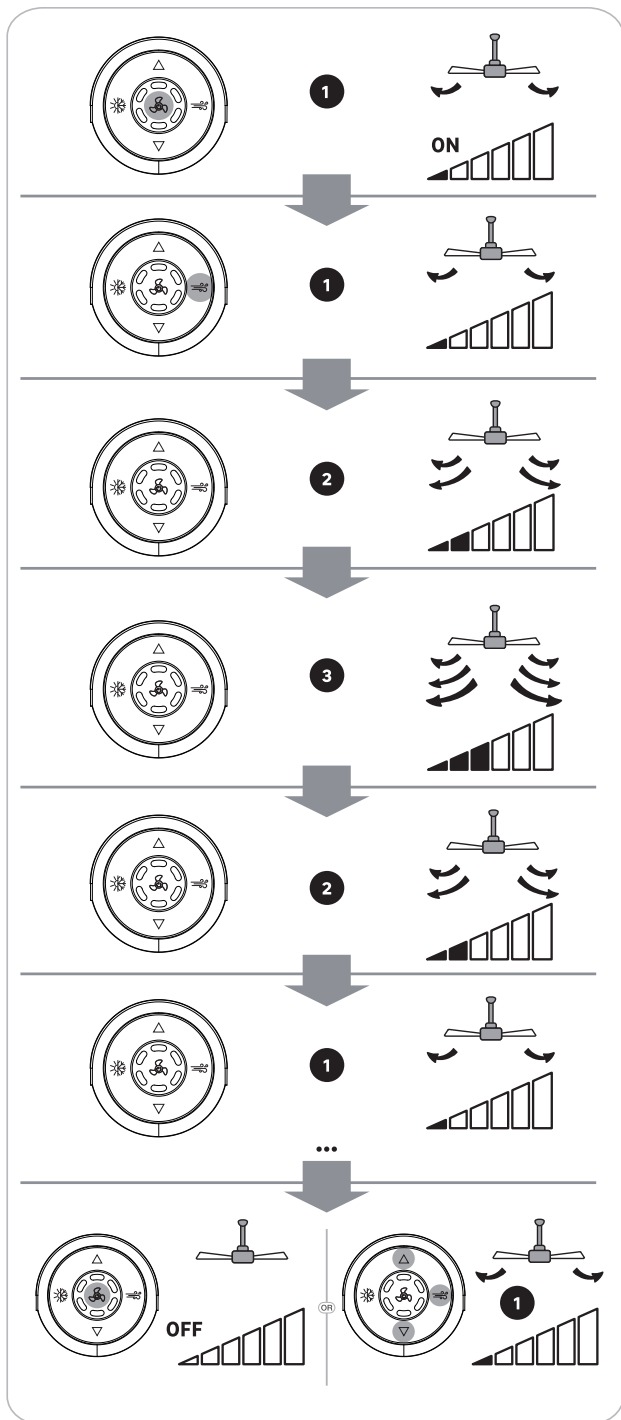
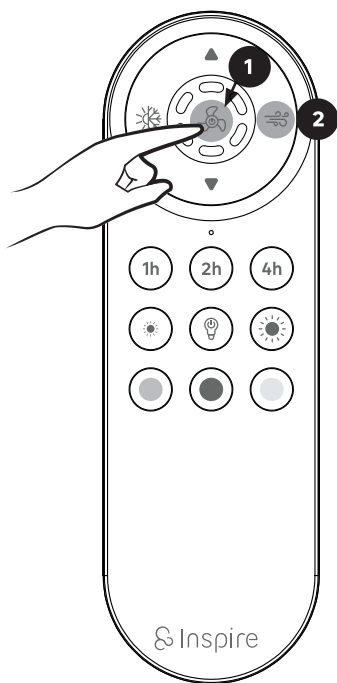

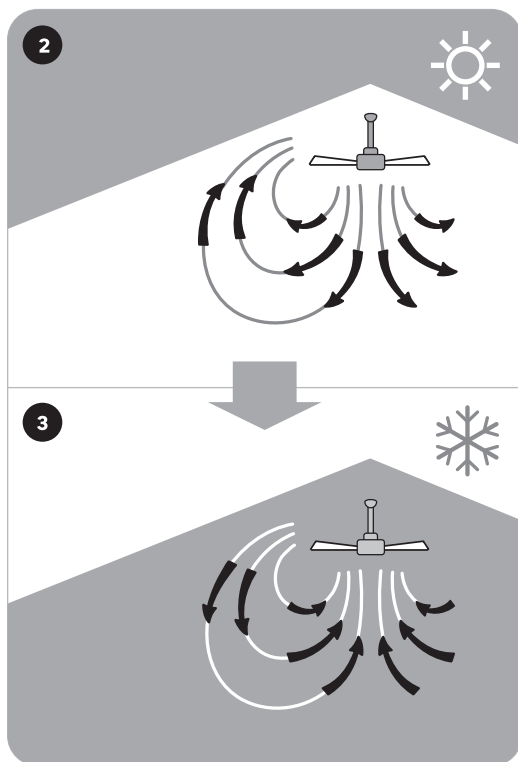
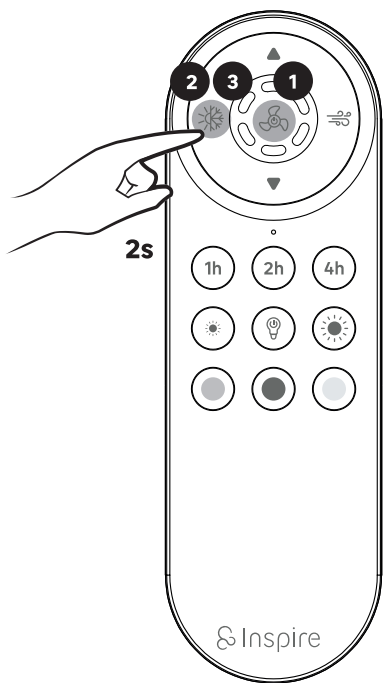

1

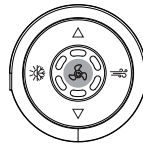

2

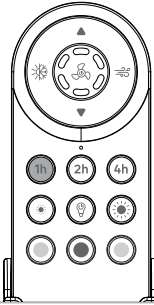

OR

3

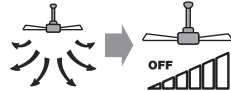
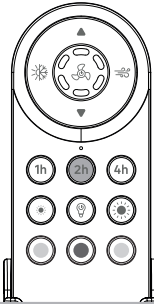

OR

4

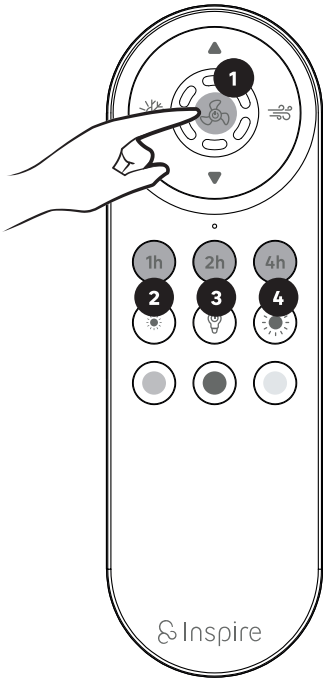
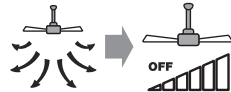
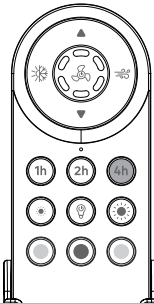

\*



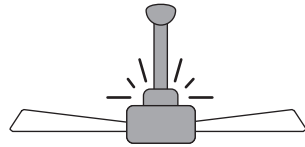
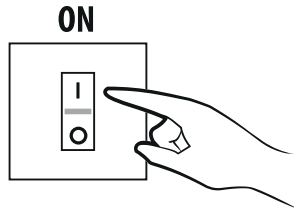
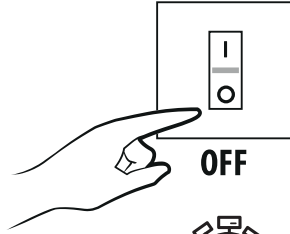













- FR** Ce produit est recyclable. S'il ne peut plus être utilisé, veuillez l'apporter dans un centre de recyclage de déchets.
- ES** Este producto es reciclable. Si ya no se puede usar, llévelo a un centro de reciclaje de residuos.
- PT** Este produto é reciclável. Se deixar de o utilizar, entregue-o num centro de reciclagem de resíduos.
- IT** Questo prodotto può essere riciclato. Se deve essere smaltito, portalo presso un centro di riciclaggio.
- EL** Αυτό το προϊόν είναι ανακυκλώσιμο. Εάν δεν μπορεί πλέον να χρησιμοποιηθεί, μεταφέρετε την σε κάποιο κέντρο ανακύκλωσης απορριμμάτων.
- PL** Ten produkt poddawany jest recyklingowi, kiedy przestaje być użyteczny należy dostarczyć go do punktu zbiórki odpadów.
- UA** Цей продукт може перероблятися. Якщо воно більше не є придатне для використання, здайте його в утилізаційний центр.
- RO** Aceast produs este reciclabil. Dacă nu mai poate fi folosit, vă rugăm să îl aduceți într-un centru de reciclare a deșeurilor.
- BR** Este produto é reciclável. Se não puder mais ser usado, descarte em um centro de reciclagem de resíduos.
- DE** Dieses Produkt ist recycelbar. Wenn es nicht mehr verwendet werden kann, bringen Sie es bitte zum Recycling-Center.
- EN** This product is recyclable. If it cannot be used anymore, please take it to waste recycling centre.



FR: Traduction de la version originale du mode d'emploi / ES: Traducción de las Instrucciones originales / PT: Tradução das Instruções Originais / IT: Traduzione delle istruzioni originali / EL: Μετάφραση των πρωτότυπων οδηγιών / PL: Tłumaczenie instrukcji oryginalnej / UA: Переклад оригінальної інструкції / RO: Traducerea instrucțiunilor originale / BR: Tradução das Instruções Originais / DE: Übersetzung der Originalversion der Gebrauchsanweisung / Original Instructions.

Made in China  
Країна походження: Китай

**EU** ADEO Services - 135 Rue Sadi Carnot - CS00001 - 59790 RONCHIN - FRANCE

**UA** Виробник: ТОВ "Адео Сервісез С.А.", вул. Саді Карно, CS 00001, 59790 Роншен, Франція.  
Імпортер: ТОВ "Леруа Мерлен Україна", 04201 Україна, м. Київ, вул. Полярна 17А, +380 44 498 46 00. Імпортер приймає претензії від споживачів щодо товару, а також проводить його ремонт, технічне і гарантійне обслуговування

**BR** LEROY MERLIN COMPANHIA BRASILEIRA DE BRICOLAGEM CNPJ: 01.438.784/0001-05  
Rua Pascoal Pais, nº. 525, 6º andar cj 61 a 64, Vila Cordeiro, São Paulo -SP. CEP: 04581-060  
CALM (Central de Atendimento Leroy Merlin) Capitais 4020-5376 Demais Regiões 0800-0205376

**ZA** Imported by Adeo South Africa (PTY) LTD T/A Leroy Merlin, Hosted in Leroy Merlin Fourways Store 35 Roos Street, Witkoppen Ext 97, Sandton, 2191 Johannesburg, Gauteng, South Africa.  
Tel: +27 10 493 8000 Email: contact@leroymerlin.co.za.