

Manual de instrucciones
Instruction manual
Manual de instruções

BEATRIZ

GRACIAS POR CONFIAR EN ARTECONFORT

Enhorabuena, acaba de adquirir un ventilador de techo Arteconfort: vanguardia tecnológica unida a la mayor eficiencia energética.

ADVERTENCIAS

Lea atentamente este manual de instrucciones antes de comenzar la instalación y guárdelo para referencia en el futuro. En caso de transferencia del aparato, entregue asimismo este manual de instrucciones a la persona correspondiente.

Cuando se utilicen aparatos eléctricos, deberán respetarse siempre las precauciones básicas de seguridad para reducir el riesgo de incendios, descargas eléctricas y lesiones personales.

PRECAUCIONES DE SEGURIDAD

- El aparato deberá ser instalado únicamente por un electricista autorizado y en conformidad con la normativa local, regional y estatal de electricidad.
- Verifique si las especificaciones eléctricas de este aparato son compatibles con su instalación.
- Desconecte la corriente antes de instalar o reparar el ventilador.
- El ventilador deberá conectarse adecuadamente a tierra para evitar riesgos de descargas eléctricas.
- La utilización y las modificaciones técnicas no autorizadas podrían suponer un peligro de lesiones e incluso de muerte.
- El ventilador debe estar conectado a un suministro eléctrico de 230V 50Hz.
- No conectar el motor del ventilador a un regulador de intensidad. Podría dar un rendimiento insatisfactorio (zumbido del motor) y causar daños al motor.
- Tenga cuidado cuando trabaje cerca de las aspas rotatorias.
- No acople nunca el ventilador a un punto de alimentación sino al propio techo.
- El ventilador debe fijarse de una estructura capaz de soportar un peso de al menos 50 kg. La fijación debe ser capaz de soportar el peso del ventilador en movimiento y no debe bambolear o soltarse.

- Este aparato está diseñado únicamente para uso en interiores. No usar en un espacio abierto ni donde pueda ser expuesto al agua o la humedad.
- No instale nunca el aparato en una sala con un grado elevado de humedad.
- El ventilador no debe ponerse en marcha en una habitación con un aparato de gas en funcionamiento al mismo tiempo.
- Este aparato puede ser utilizado por niños de 8 años en adelante y de personas con capacidades físicas, sensoriales o mentales reducidas o falta de experiencia y conocimiento si son supervisados o instruidos acerca del uso del aparato de forma segura y comprender los riesgos involucrados. Así como de la limpieza y el mantenimiento del aparato.
- Los niños no deben jugar con el aparato.
- Para invertir el sentido de las aspas, realizarlo en movimiento.
- No introduzca ningún objeto en las aspas del ventilador mientras están girando. Esto puede dañarlas y alterar el equilibrio del ventilador hasta tumbarlo.
- Después de que el ventilador esté completamente instalado asegúrese de que todas las fijaciones están bien sujetas para evitar cualquier tambaleo o caída de la máquina.

Las instrucciones y las normas de seguridad de este manual no pueden prevenir todas las condiciones y situaciones que pudieran ocurrir. Por razones obvias, el presente manual no puede incluir factores como la precaución y el cuidado. Estos factores deberán ser asumidos por quien instala, mantiene, utiliza y disfruta el producto.

MEDIO AMBIENTE



No tire aparatos eléctricos a la basura doméstica, utilice instalaciones de recogida selectiva. Consulte a las autoridades locales para obtener más información.

Si los aparatos eléctricos se depositan en vertederos, los componentes peligrosos pueden filtrarse en las aguas subterráneas y entrar en la cadena alimentaria, dañando su salud y bienestar.

Gracias por cuidar del medio ambiente.

ANTES DE LA INSTALACIÓN

Abra la caja evitando el uso de cuchillas o "cutters" para no rallar los componentes del ventilador.

Desembale las piezas manipulándolas de forma cuidadosa para que no se doblen o arañen, y coloque el motor sobre un trapo o una superficie blanda para evitar que se dañe (también puede utilizar la espuma antigolpes de la caja para este fin). Nunca apoye el motor de lado.

Es aconsejable montar el ventilador en el suelo o una superficie lo suficientemente grande para que no se caiga ningún componente.

Identifique todas las piezas antes de comenzar el montaje.

SOLUCIÓN DE PROBLEMAS

Antes de realizar las comprobaciones que se detallan a continuación, el ventilador debe encontrarse sin alimentación eléctrica.

1. El ventilador no arranca

- Sustituya las pilas del mando si están agotadas o no son las adecuadas.
- Compruebe que no haya dispositivos cercanos que puedan estar causando interferencias con el mando o reduciendo la recepción de la señal.
- Resincronice el mando.
- Compruebe que las conexiones eléctricas están correctamente realizadas (debe realizarlo un electricista autorizado).
- Compruebe fusibles e interruptores, que la instalación dispone de tensión y ésta llega al ventilador.
- Revise que las clemas estén bien conectadas y los cables están correctamente fijados en el interior.

2 El ventilador no arranca pero la luz si

- Estando el ventilador apagado, comprueba con la mano que las aspas giran libremente.

3. El ventilador hace excesivo ruido al girar

- Permita una ligera separación entre el florón y el techo, evitando que se toquen directamente.
- Compruebe que los tornillos de fijación de las palas, los tornillos de fijación a techo, tija y al burlón estén correctamente apretados.
- Si ha sustituido el control remoto o el receptor

originales, vuelva a instalar los suministrados junto con el ventilador.

4. El ventilador se tambalea

- Compruebe que los tornillos de fijación de las palas, los tornillos de fijación a techo, tija y al burlón estén correctamente apretados.

5. El ventilador no da aire o el flujo de aire es insuficiente

- Revise que las aspas no estén montadas al revés.
- Compruebe que las aspas giran en el sentido correcto (Verano/Invierno).
- Evite los objetos cercanos que puedan obstaculizar la circulación del aire.
- Verifique que el diámetro de las aspas de su ventilador es suficiente para el área de la habitación en la que se encuentra instalada.

6. La luz no se enciende

- Revise que las clemas estén bien conectadas y los cables están correctamente fijados en el interior.
- Si su ventilador cuenta con luz LED incluida, revise que las conexiones estén bien fijadas de acuerdo al manual de instrucciones.

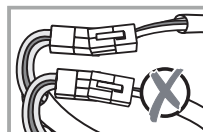
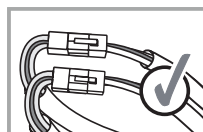

Este producto contiene una fuente luminosa de la clase de eficiencia energética D - (EU) 2019/2015

THANKS FOR TRUSTING IN ARTECONFORT

Congratulations, you have just purchased an Arteconfort ceiling fan: cutting edge technology combined with the highest energy efficiency.

WARNING

Read this instruction manual carefully before beginning installation and save it for future reference. In case of transfer of the device, you must also give this instruction manual to the corresponding person.

While using electrical appliances, basic safety precautions should always be followed to reduce the risk of fire, electric shock and personal injury.

CAUTION

- The product must only be installed by an authorized electrician and in compliance with local, regional and state electricity regulations.
- Check if the electrical specifications of this device are compatible with your installation.
- Turn off the power before installing or repairing the fan.
- The fan must be properly grounded to avoid the risk of electric shock.
- Use and unauthorized technical modifications could suppose a risk of injury.
- The fan must be connected to a 230V 50Hz power supply.
- Do not connect the fan motor to a current dimmer. It could give unsatisfactory performance (engine humming) and cause engine damage.
- Be careful while working near the spinning blades.
- Never connect the fan to a power point but to the ceiling itself.
- The fan must be hung from a structure capable of supporting a weight of at least 50 kg. The fixture must be able to support the weight of the fan in motion and should not wobble or loosen.
- This device is designed for indoor use only. Do not use in an open space or where it may be exposed to water or moisture.
- Never install the appliance in a room with a high degree of humidity.
- The fan must not be started in a room with a

- gas appliance running at the same time.
- This device can be used by children aged 8 years and above and of people with reduced physical, sensory or mental abilities or lack of experience and knowledge if they are supervised or instructed about the use of the device safely and understand the risks involved. As well as cleaning and maintenance of the device.
- Children should not play with the device.
- To reverse the direction of the blades, do it while moving.
- Do not insert any object into the fan blades while they are rotating. This can damage them and alter the balance of the fan and the device can fall down.
- After the fan is fully installed make sure all fasteners are securely fastened to prevent any wobbling or falling of the machine.

The instructions and safety regulations in this manual cannot prevent all conditions and situations that may occur. For obvious reasons, this manual cannot include factors such as caution and care. These factors must be assumed by who installs, maintains, uses and enjoys the product.

ENVIRONMENT



Do not throw electrical appliances into the household waste, use selective collection facilities. Consult local authorities for more information.

If electrical appliances are deposited in landfills, hazardous components can seep into groundwater and enter the food chain, damaging health and well-being.

Thanks for taking care of the environment.

BEFORE INSTALLATION

Open the box avoiding the use of blades or "cutters" to avoid scratching the fan components.

Unpack the parts handling them carefully so that they do not bend or scratch, and place the motor on a cloth or a soft surface to prevent damage (you can also use the anti-shock foam on the box for this purpose). Never support the motor sideways.

It is advisable to mount the fan on the floor or a surface large enough so that no component falls.

Identify all parts before beginning assembly.

PROBLEM SOLVING

Before carrying out the checks detailed below, the fan must be without power supply.

1. The fan does not start

- Replace the remote control batteries if they are exhausted or not suitable.
- Check that there are no nearby devices that may be causing interference with the remote or reducing signal reception.
- Resynchronize the remote control.
- Check that the electrical connections are correct (must be carried out by a licensed electrician).
- Check fuses and switches, that the installation has voltage and it reaches the fan.
- Check that the terminals are properly connected and the cables are correctly fixed inside.

2. The fan doesn't start but the light does.

- With the fan off, check with your hand that the blades turn freely.

3. The fan makes excessive noise while rotating

- Allow a slight separation between the canopy and the ceiling, preventing them from touching directly.
- Check that the fixing screws of the blades, the fixing screws to the roof, the stem and the fastening elements are correctly tightened.
- If you replaced the original remote control or receiver, reinstall the supplied ones along with the fan.

4. The fan wobbles

- Check that the fixing screws of the blades, the fixing screws to the roof, the stem and the fastening elements are correctly tightened.

5. The fan does not give air or the air flow is insufficient

- Check that the blades are not mounted backwards.
- Check that the blades rotate in the correct direction (Summer / Winter).
- Avoid nearby objects that may impede air circulation.
- Verify that the diameter of the blades of your fan is sufficient for the area of the room in which it is installed.

6. The light does not turn on

- Check that the terminals are properly connected and the cables are correctly fixed inside.
- If your fan has LED light included, check the connections are properly fixed according to the instruction manual.

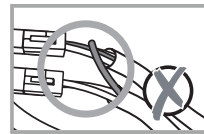
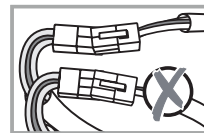
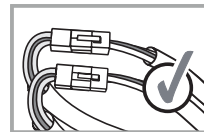

This product contains a light source of energy efficiency class D - (EU) 2019/2015

OBRIGADO POR CONFIAR EM ARTECONFORT

Parabéns, você acaba de comprar um ventilador de teto Arteconfort: tecnologia de ponta, juntamente com o aumento da eficiência energética.

AVISOS

Por favor, leia atentamente este manual de instruções antes de iniciar a instalação e guardar para referência futura. No caso de transferência da unidade, também entregue este manual à pessoa correspondente.

Ao utilizar aparelhos eléctricos, devem ser respeitadas as precauções básicas de segurança para reduzir o risco de incêndio, choque eléctrico e ferimentos pessoais.

PRECAUÇÕES

- O aparelho só deve ser instalado por um electricista autorizado e de acordo com os regulamentos locais, regionais e estaduais de electricidade.
- Verifique se as especificações eléctricas deste aparelho são compatíveis com a sua instalação.
- Desligue a alimentação antes de instalar ou reparar o ventilador.
- O ventilador deve ser devidamente aterrado para evitar o risco de choque eléctrico.
- O uso e alterações técnicas não autorizadas podem constituir um risco de ferimento.
- O ventilador deve ser conectado a uma fonte de 230V 50Hz.
- Não ligue o motor do ventilador a um regulador de intensidade. Poderia dar o desempenho insatisfatório (zumbido do motor) e causar dano do motor.
- Tenha cuidado ao trabalhar perto de lâminas rotativas.
- Nunca prenda o ventilador a um ponto de potência, mas ao próprio tecto.
- O ventilador deve ser pendurado a partir de uma estrutura capaz de suportar um peso de pelo menos 50 kg. A fixação deve ser capaz de suportar o peso do ventilador em movimento e não deve ser bambole ou liberado.
- Este aparelho destina-se apenas ao uso interno. Não utilize num espaço aberto ou onde possa

estar exposto a água ou humidade.

- Nunca instale o aparelho numa sala com um elevado grau de humidade.
- O ventilador não deve ser iniciado numa sala com um aparelho a gás a funcionar ao mesmo tempo.
- Este aparelho pode ser usado por crianças de 8 anos em diante e pessoas com capacidades físicas, sensoriais ou mentais, reduzidas ou falta de experiência e conhecimento si são supervisionadas por um adulto ou instruídos sobre o uso do aparelho com segurança e compreender o riscos envolvidos. Assim como a Limpeza e manutenção do aparelho.
- As crianças não devem brincar com o aparelho.
- Para inverter a direcção das lâminas, faça-o em movimento.
- Não insira nenhum objeto nas lâminas do ventilador enquanto eles estão girando. Isto pode danificá-los e alterar o equilíbrio do ventilador até que seja derrubado.
- Depois que o ventilador é instalado inteiramente certifique-se de que todas as ligações estão fixadas firmemente para evitar nenhuma oscilações ou quedas da máquina.

As Instruções e regras de segurança, não podem impedir todas as condições e situações que podem ocorrer. Por razões óbvias, este manual não pode incluir fatores tais como o cuidado e atenção. Estes fatores devem ser assumidos por quem instala, mantém, usa e desfrutar o produto.

MEIO AMBIENTE



Não descarte de aparelhos eléctricos para lixo doméstico, utilize as instalações de recolha selectiva. Consulte as autoridades locais para obter mais informações.

Se os aparelhos eléctricos são depositados em aterros sanitários, os componentes perigosos podem infiltrar-se nas águas subterrâneas e entrar na cadeia alimentar, prejudicando a sua saúde e bem-estar.

Obrigado por cuidar do meio ambiente.

ANTES DA INSTALAÇÃO

Abra a caixa evitando o uso de facas ou cortadores para evitar o grating dos componentes do ventilador.

Desembale as peças com cuidado para não dobrar nem arranhar, e colocar o motor sobre um pano ou superfície macia para evitar danos (você pode igualmente usar a espuma shock-proof da caixa para esta finalidade). Nunca apoie o motor do lado.

É aconselhável montar o ventilador no chão ou em superfície grande o suficiente para que nenhum componente caia.

Identificar todas as peças antes da montagem.

SOLUÇÃO DE PROBLEMAS

Antes de executar as verificações detalhadas abaixo, o ventilador deve estar sem energia.

1. O ventilador não começa

- Substitua as pilhas do controlador se estiverem esgotadas ou não adequadas.
- Verifique se não há dispositivos próximos que possam estar causando interferência com o controlador ou reduzindo a recepção do sinal.
- Resincronize o controlador.
- Verifique se as conexões elétricas estão feitas corretamente (deve ser feito por um electricista autorizado).
- Verifique os fusíveis e interruptores, se a instalação tem tensão e llega correctamente o ventilador.
- Verificar se os terminais estão corretamente ligados e se os cabos estão corretamente fixados no interior.

2. O ventilador não liga, mas a luz sim.

- Com o ventilador desligado, verifique com a mão se as pás giram livremente.

3. O ventilador faz o ruído excessivo ao girar

- Permitir uma ligeira separação entre a flor e o tecto, impedindo-os de tocar directamente.
- Verifique se os parafusos de fixação da pá e os parafusos de fixação do teto, espigão e burlão estão apertados.
- Se tiver substituído o telecomando ou o receptor

original, reinstale os fornecidos juntamente com a ventoinha.

4. O ventilador oscila

- Verifique se os parafusos de fixação da pá e os parafusos de fixação do teto, espigão e burlão estão apertados.

5. O ventilador não fornece ar ou o fluxo de ar é insuficiente

- Verifique se as lâminas não estão montadas para trás.
- Verifique se as lâminas giram na direção correta (verão/inverno).
- Evite objetos próximos que possam impedir a circulação de ar.
- Verifique se o diâmetro das lâminas do seu ventilador é suficiente para a área da sala em que está instalado.

6. A luz não liga

- Verificar se os terminais estão corretamente ligados e se os cabos estão corretamente fixados no interior.
- Se o seu ventilador tiver uma luz LED incluída, verifique se as conexões estão fixadas de forma segura de acordo com o manual de instruções.

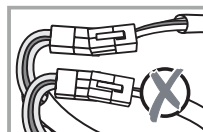
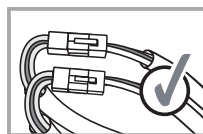

Este produto contém uma fonte de luz da classe de eficiência energética D - (EU) 2019/2015

GUIA GENERAL: PARTES DE UN VENTILADOR

GENERAL GUIDE: PARTS OF A FAN

GUIA GERAL: PARTES DE UM VENTILADOR

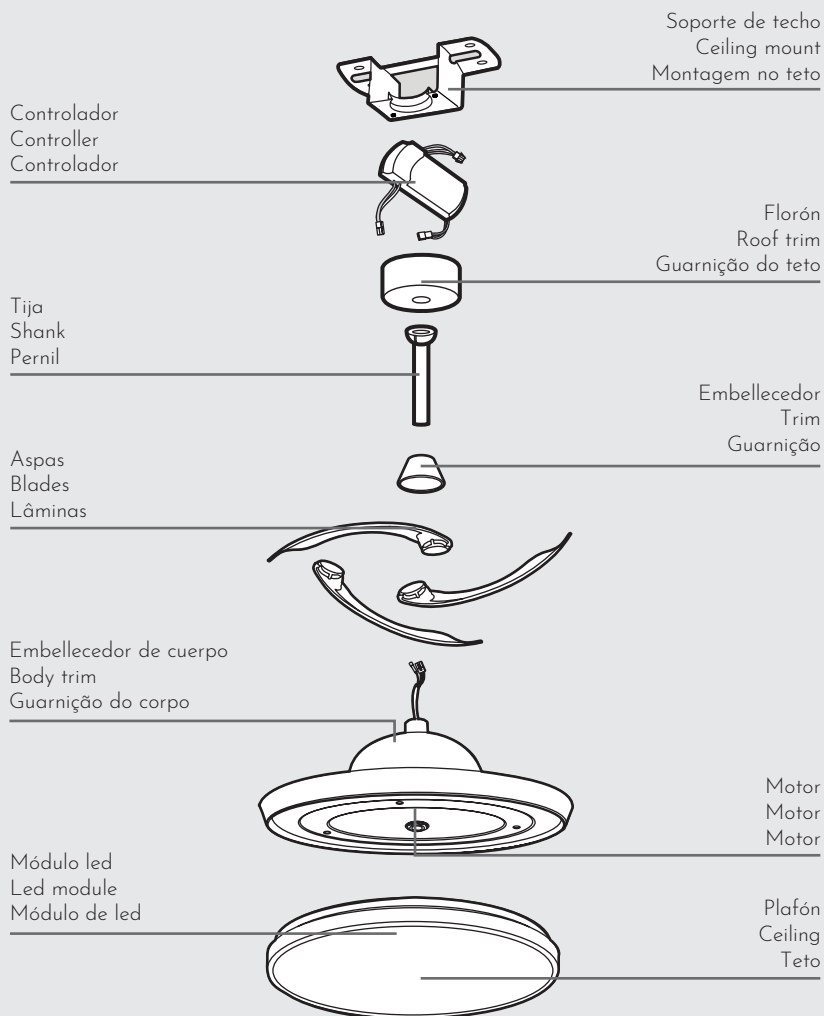

GUIA PARA TORNILLOS

SCREW GUIDE

GUIA DE PARAFUSO



TORNILLOS PARA TECHO

SCREWS FOR THE ROOF

PARAFUSOS PARA O TELHADO

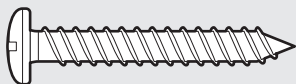

Tornillos para techo
Screws for the roof
Parafusos para o telhado

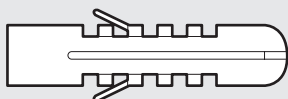

Tacos para tornillo de techo
Ceiling screw plugs
Bujões de teto



Arandela para tornillo de techo
Washer for ceiling screw
Arruela para parafuso de teto

TORNILLOS PARA ASPAS

SCREWS FOR BLADES

PARAFUSOS PARA LÂMINAS

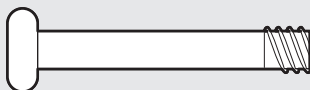

Tornillo para aspas de madera
Screw for wood blades
Parafuso para lâminas de madeira

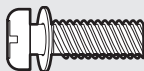

Tornillo para aspas con arandela
Screw for blades with washer
Parafuso para lâminas com arruela

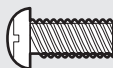

Tornillo para aspas
Screw for blades
Parafuso para lâminas



Arandela de papel para tornillo de aspa
Arruela de papel para parafuso de lâmina
Paper washer for blade screw



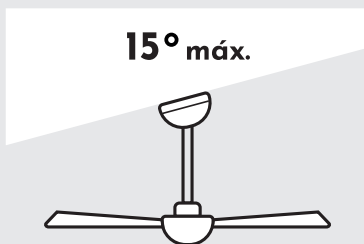
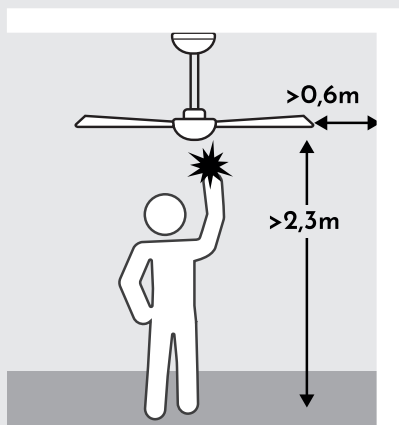
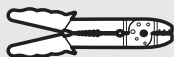
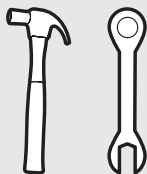
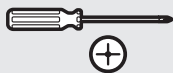
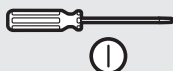
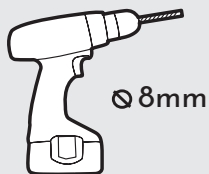

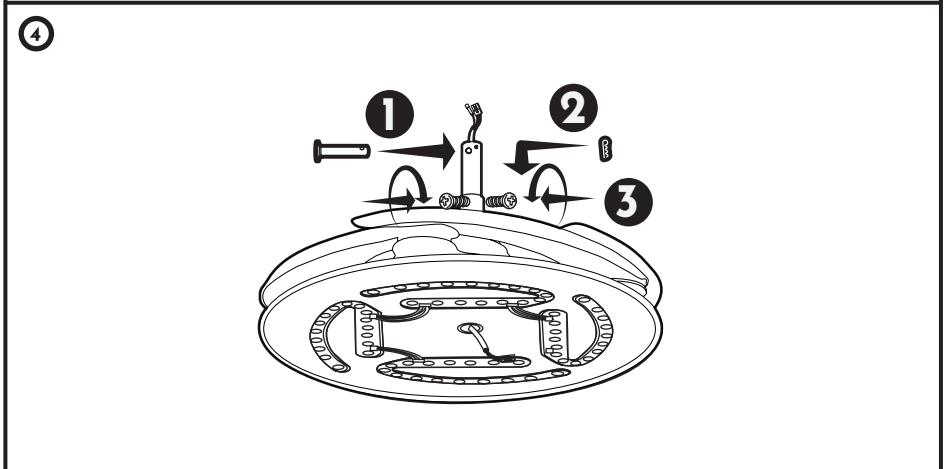
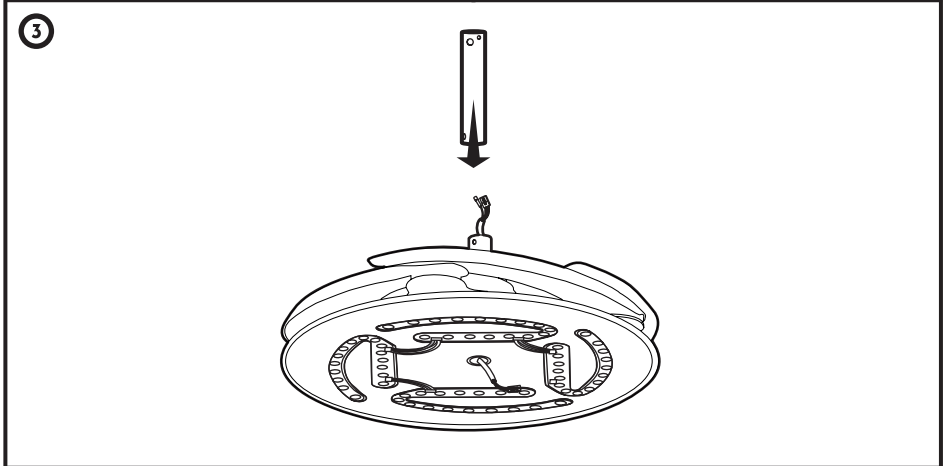
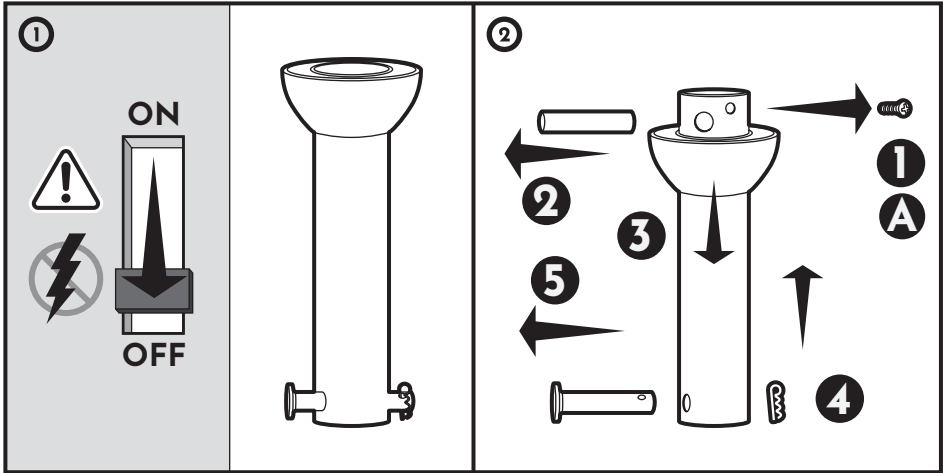



5

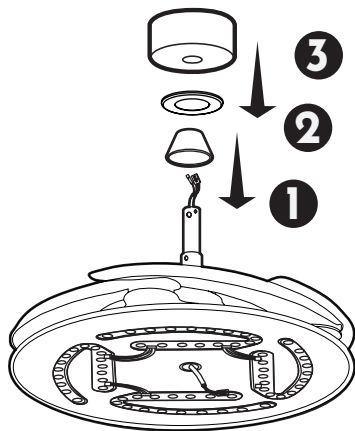

6

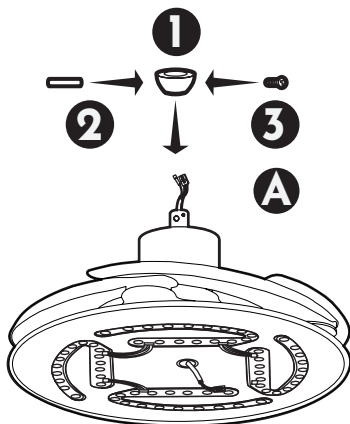

7

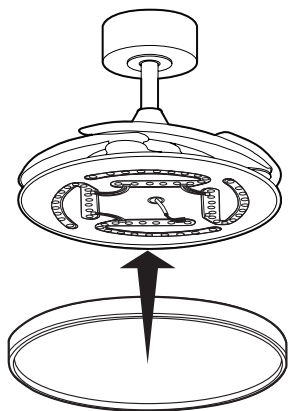

8

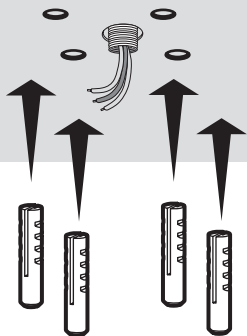

9

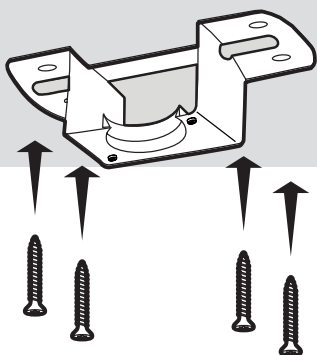

10

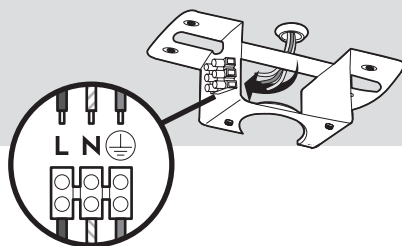

11

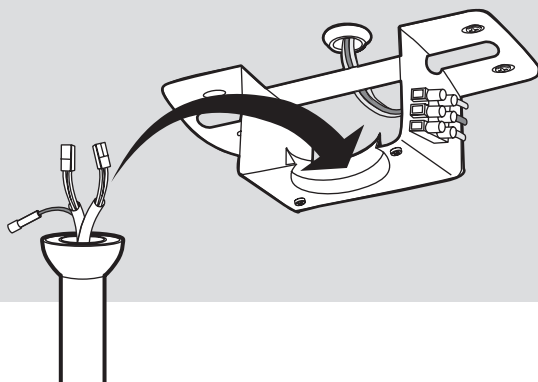

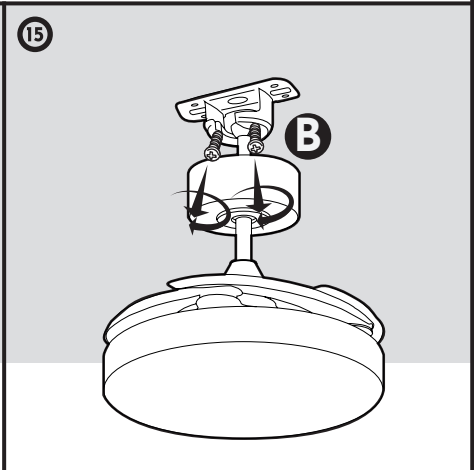
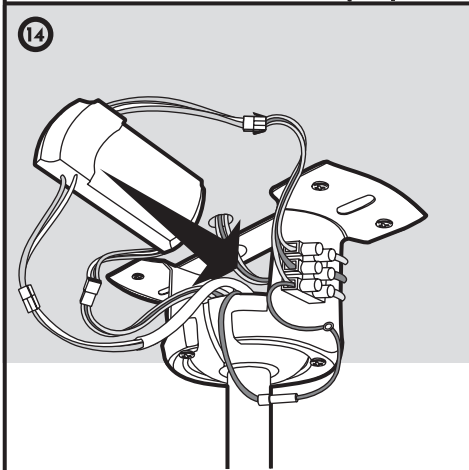
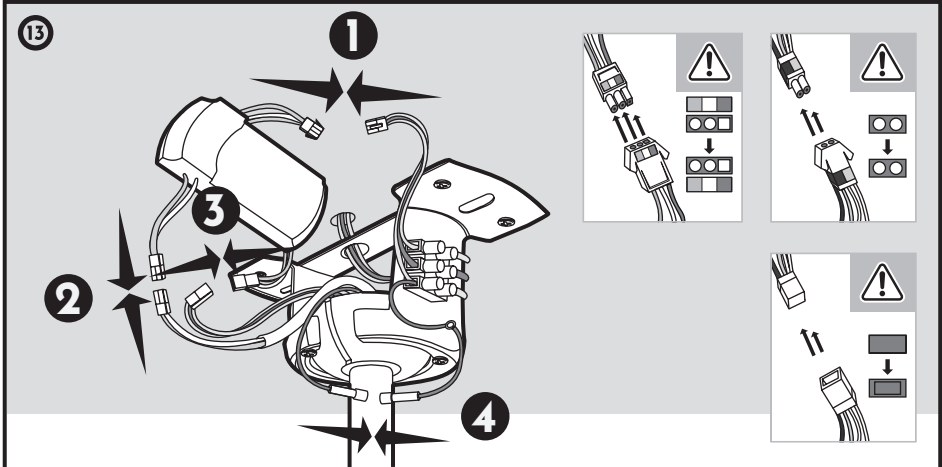
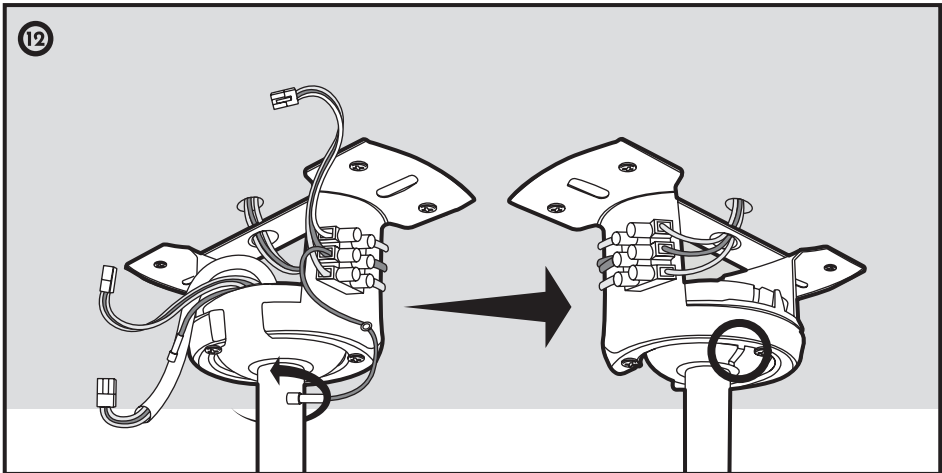

18

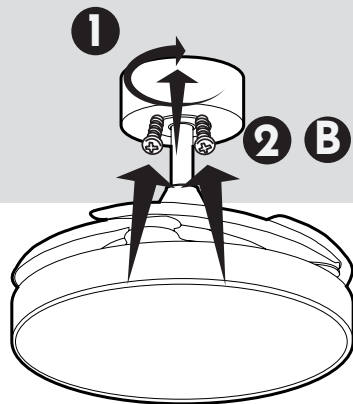

19

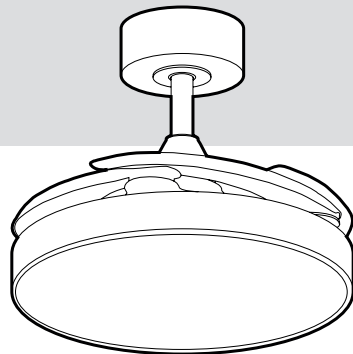

20

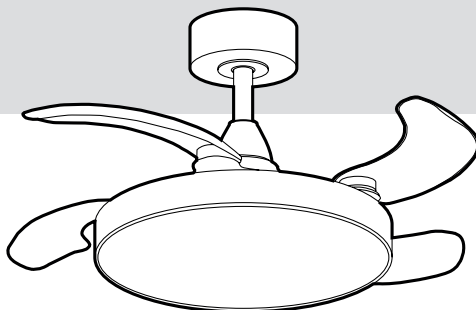

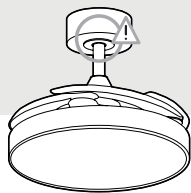

OR

max. 15°

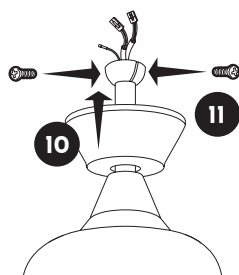
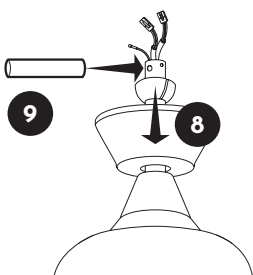
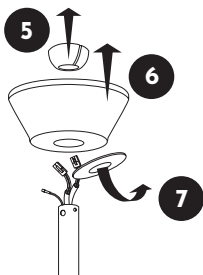
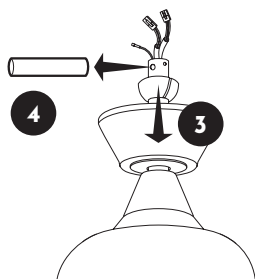
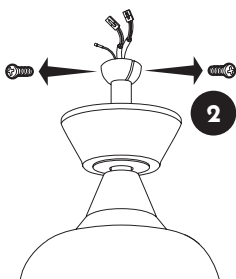
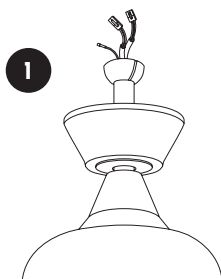
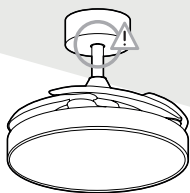



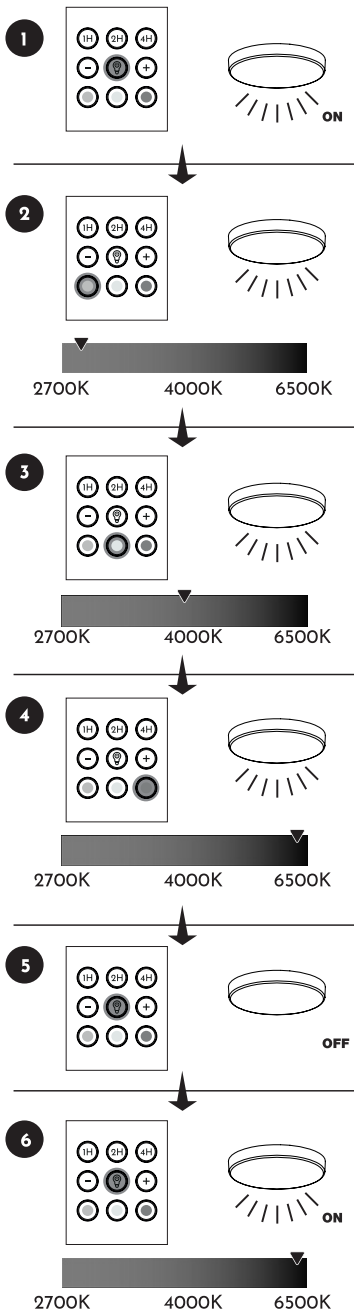
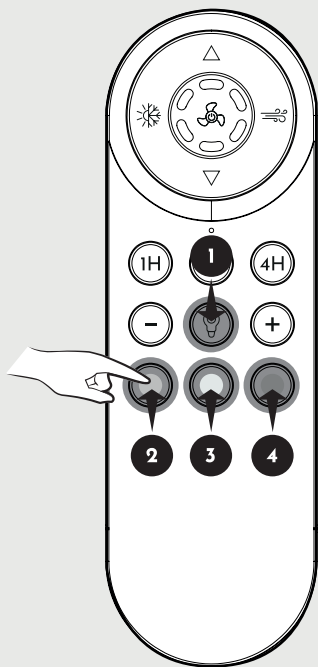

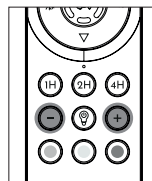
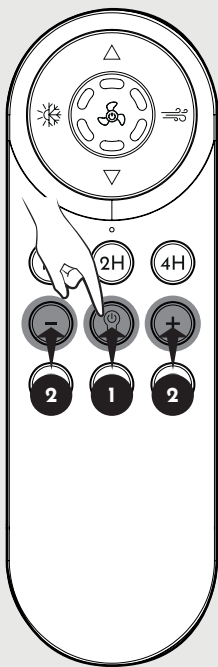

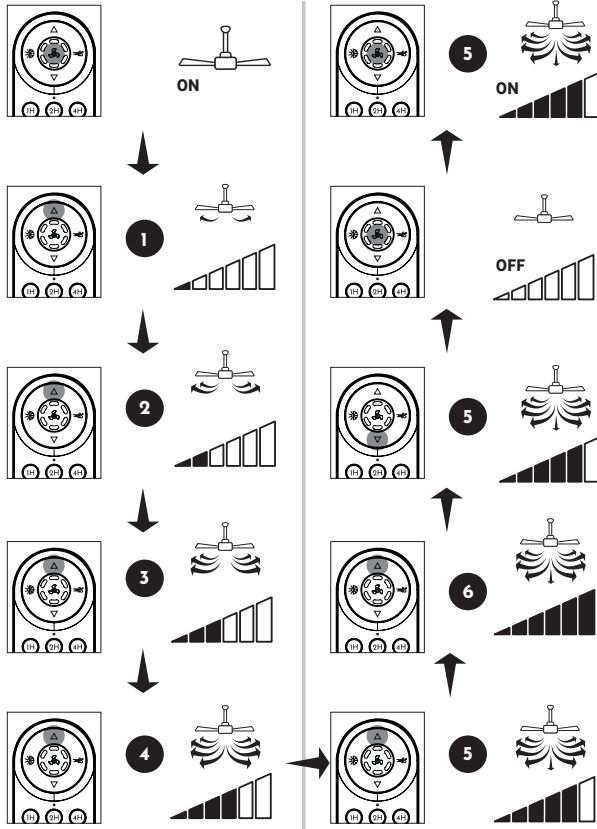
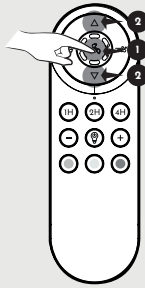

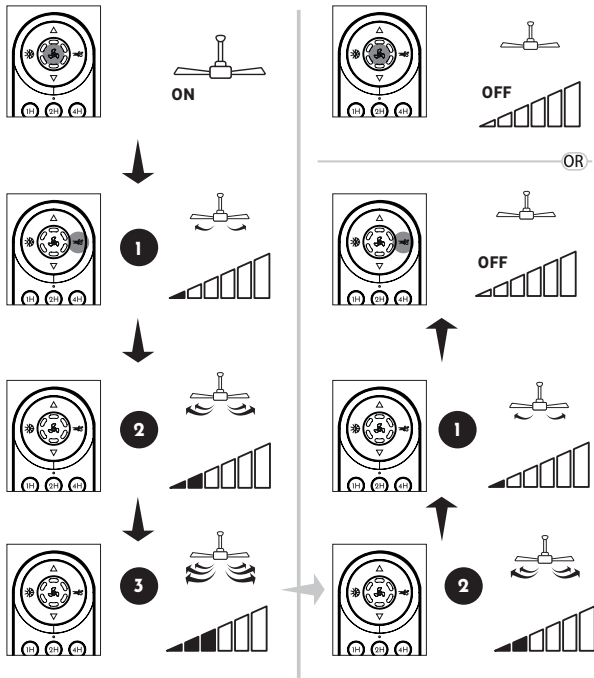
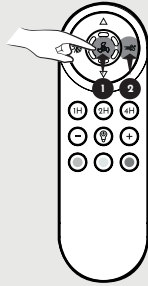

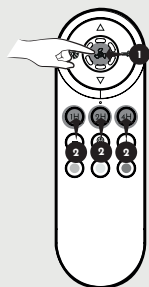

1



2



OR

3



OR

4



5



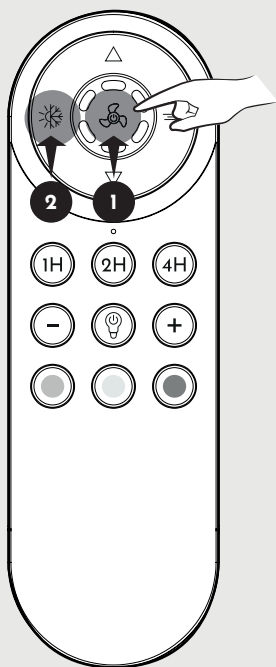

1

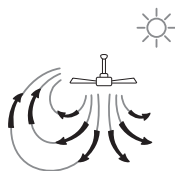

2



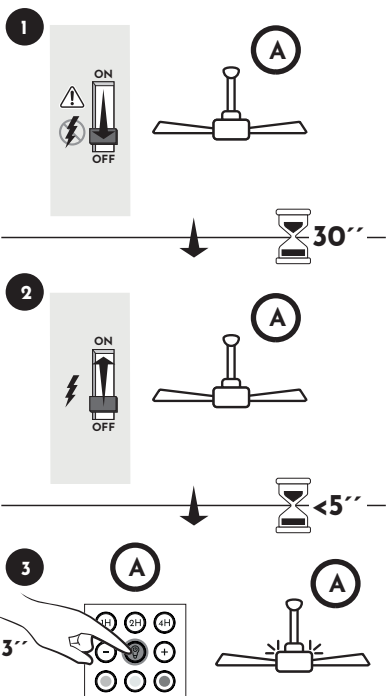
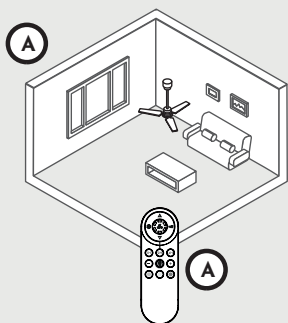

*El mando viene sincronizado de fábrica, solo debe resincronizar el mando si ha perdido la sincronización, adquirido uno nuevo o desea controlar varios ventiladores con un sólo mando.

*The controller is synchronised at the factory, you only need to resynchronise the controller if you have lost synchronisation, purchased a new one or wish to control several fans with one controller.

*O controlador é sincronizado na fábrica. Só é necessário voltar a sincronizar o controlador se tiver perdido a sincronização, se tiver adquirido um novo controlador ou se pretender controlar várias ventoinhas com um controlador.

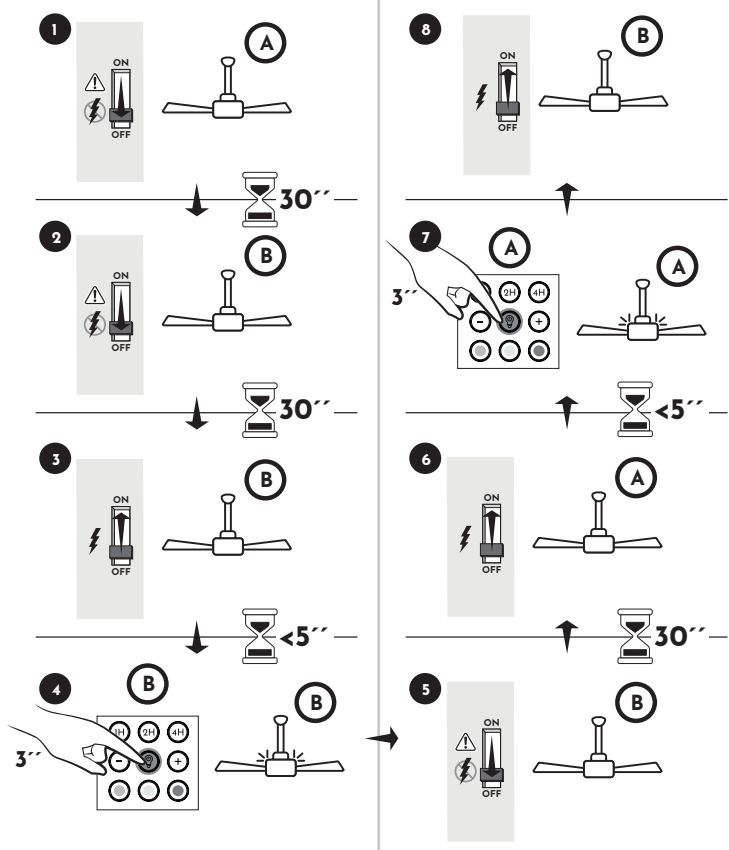
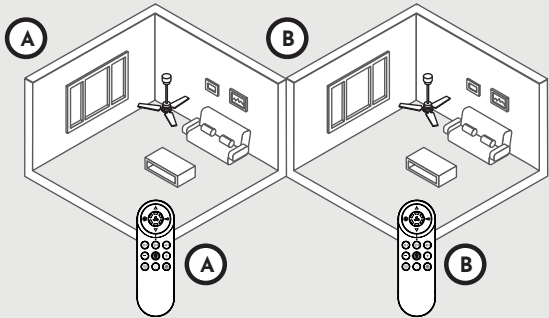

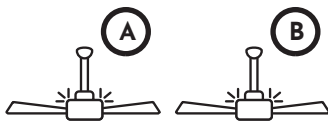
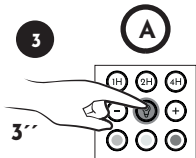
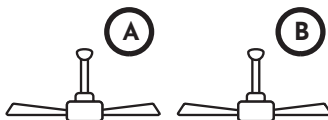
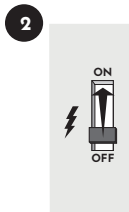
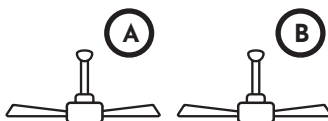
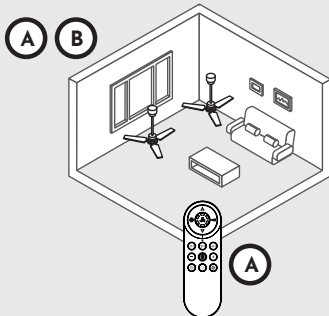

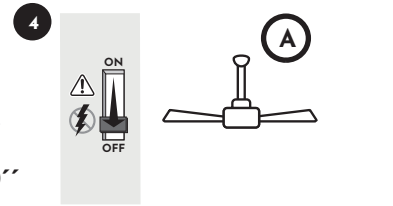
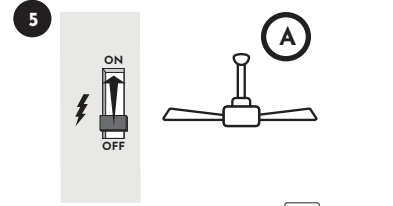
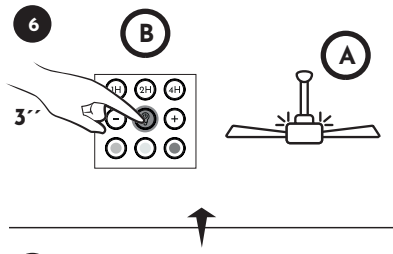
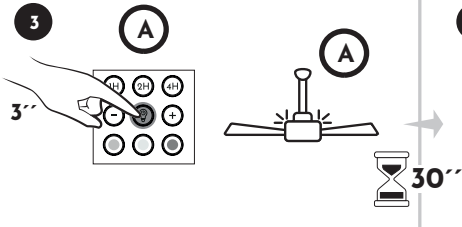
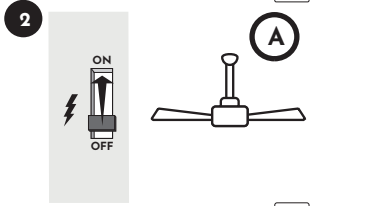
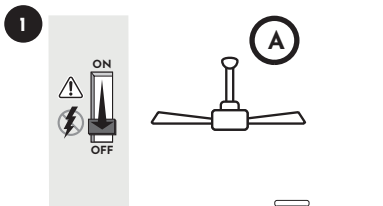
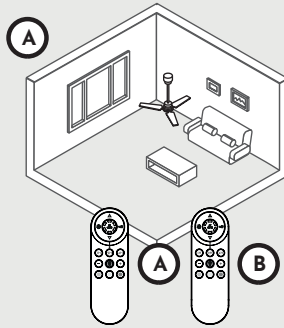



*Retire las pilas del mando si no se va a utilizar durante un tiempo prolongado.

*Remove the batteries from the remote control if it will not be used for a long period of time.

*Retire as pilhas do telecomando se este não for utilizado durante um longo período de tempo.

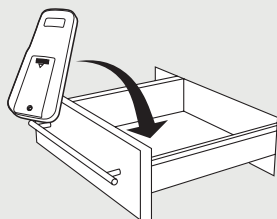

1



2

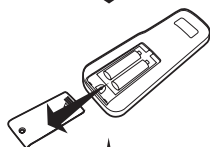

3

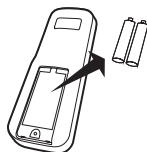

4

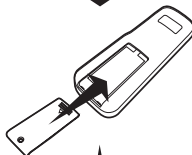

5



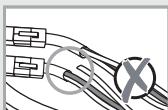
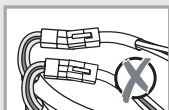
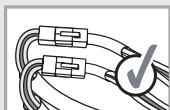
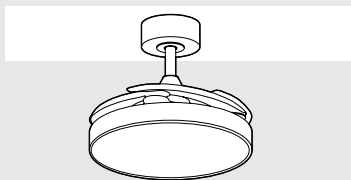
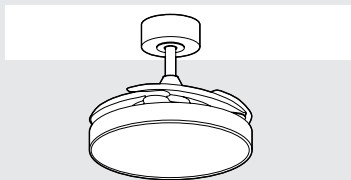
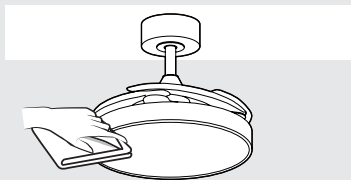

REPUESTOS DISPONIBLES

Puede solicitar repuestos acudiendo a la tienda donde lo adquirió o en otra de la misma cadena. Si el producto está en garantía presente el ticket o factura de compra.

SPARE PARTS

You can request spare parts by going to the store where you purchased it or to any another of the brand. If the product is under warranty, present the purchase receipt or invoice.

PEÇAS DE REPOSIÇÃO DISPONÍVEIS

Você pode solicitar peças de reposição indo até a loja onde as comprou ou em outra da mesma rede. Se o produto estiver na garantia, apresente o comprovante ou a fatura de compra .

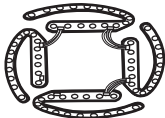
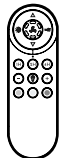
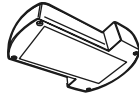

	DESCRIPCIÓN DESCRIPTION DESCRIÇÃO	REFERENCIA REFERENCE REFERÊNCIA
	Tulipa de la luz Light cover Tulipa de luz	PLABEATRIZS
	Placa LED LED module Placa de LED	LEDBEATRIZ
	Mando a distancia Remote control Remote control	MANBEATRIZSONLY
	Controlador Driver Controller	CONBEATRIZSONLY



GARANTÍA

El motor de este ventilador tiene una garantía de 8 años y de 5 años para el resto de los componentes. La garantía cubre el cambio o reparación de cualquier avería o defecto del aparato, siempre que el mismo sea debido a un fallo de fabricación o un componente defectuoso.

IMPORTANTE

Es imprescindible para el uso de esta garantía acreditar la fecha de compra del producto. Por lo que será necesario presentar el ticket o factura de compra, así como este manual de instrucciones.



**Conserve el ticket de compra
y el manual de instrucciones.**

La garantía de este producto no se aplica si los defectos del aparato han sido causados por:

- Daños durante transportes no realizados por el fabricante. (Ejemplo: abolladuras, roturas de componentes o piezas de cristal...).
- Realización de instalaciones o montajes incorrectos.
- Mala conservación del producto.
- Daños causados por el contacto del aparato con sustancias químicas o inapropiadas. Este ventilador está diseñado para uso exclusivo en interior por lo que tampoco debe ser expuesto al agua y/o humedad.
- El reemplazo o uso de piezas adicionales o accesorios que no sean originales del fabricante.
- Si se utiliza un control a través de un regulador de intensidad de pared diferente al control remoto suministrado con el ventilador.

Antes de acudir al servicio técnico, es aconsejable leer la guía de solución de problemas incluida en este manual.

WARRANTY

The motor of this fan is guaranteed for 8 years and 5 years for the rest of the components. This warranty covers the exchange or repair of any failure or defect of the device, provided that it is due to a manufacturing fault or a defective component.

IMPORTANT

It is essential for the use of this guarantee to prove the purchase date of the product. Therefore, it will be necessary to present the purchase receipt as well as this instruction manual.



**Keep the purchase receipt
and the instruction manual.**

The warranty of this product does not apply if the defects of the device have been caused by:

- Damage during transport not carried out by the manufacturer. (Example: dents, components or glass pieces damages ...)
- Carrying out incorrect installations or assemblies.
- Poor preservation of the product.
- Damage caused by contact of the device with chemical or inappropriate substances. This fan is designed for indoor use only, so it should not be exposed to water and / or humidity either.
- The replacement or use of additional parts or accessories that are not original from the manufacturer.
- When using a control through a wall dimmer other than the remote control supplied with the fan.

Before calling for technical assistance, it is advisable to read the troubleshooting guide included in this manual.

GARANTIA

O motor deste ventilador tem garantia de 8 anos e 5 anos para os demais componentes. Esta garantia cobre a troca ou reparo de qualquer defeito no dispositivo, desde que seja devido a uma falha de fabricação ou um componente com defeito.

IMPORTANTE

É imprescindível para a utilização desta garantia comprovar a data de compra do produto. Portanto, será necessário apresentar o comprovante de compra ou nota fiscal, bem como este manual de instruções.



Guarde o recibo de compra e o manual de instruções.

A garantia deste produto não se aplica se os defeitos do dispositivo forem causados por:

- Danos durante o transporte não realizados pelo fabricante. (Exemplo: amassados, barulho de componentes ou pedaços de vidro ...).
- Executando instalações ou montagens incorretas.
- Má conservação do produto.
- Danos causados pelo contato do dispositivo com substâncias químicas ou inadequadas. Este ventilador é projetado apenas para uso interno, portanto, não deve ser exposto à água e / ou umidade. uição ou uso de peças ou acessórios adicionais que não sejam originais do fabricante
- Se estiver usando um controle através de um dimmer de parede diferente do controle remoto fornecido com o ventilador.

Antes de entrar em contato com o serviço, é aconselhável ler o guia de solução de problemas incluído neste manual.



Si tiene alguna pregunta, incidencia o falta de componentes, consulte con su distribuidor. También puede consultarnos a través del correo electrónico info@arteconfort.com o mediante el formulario de contacto disponible en nuestra página web.

If you have any questions, problems or missing components, consult your dealer. You can also contact us through the email info@arteconfort.com or through the contact form available on our website.

Se você tiver dúvidas, problemas ou componentes ausentes, consulte seu revendedor. Você também pode entrar em contato conosco através do e-mail info@arteconfort.com ou através do formulário de contato disponível em nosso site.



   | www.arteconfort.com

ARTECONFORT HOTEL S.L.
Ctra. Andalucía, 6
45224 Seseña Nuevo
Toledo, España