



- E** INSTRUCCIONES DE MONTAJE
- I** INTRUZIONI DI MONTAGGIO
- F** INSTRUCTIONS DE MONTAGE
- P** INSTRUCAO DE MONTAGEM
- GB** INSTALLATION INSTRUCTIONS



20
 COMPLEMENTOS DECORATIVOS DEL
 BAÑO, S.L.
 Avda. Can Roqueta 70, 08202 Sabadell, Barcelona,
 España

DdP nº 6

UNE-EN 14428:2016+A1:2019

Higiene Personal

Endurancia: cumple
 Estabilidad: cumple
 Estanqueidad: cumple

TA16S01

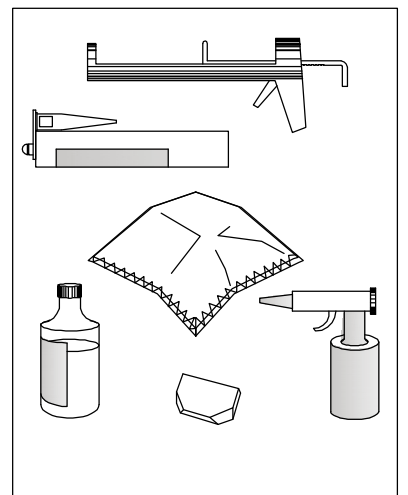
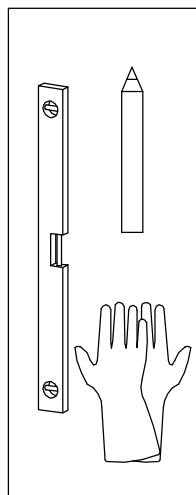
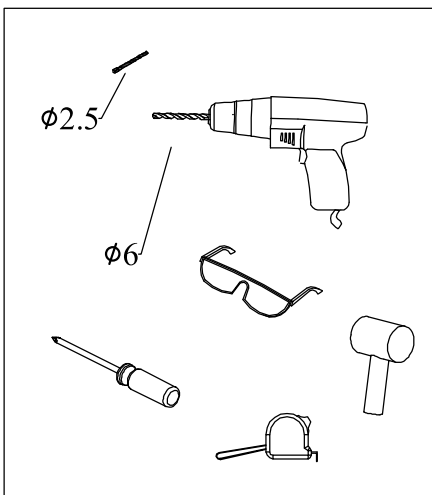
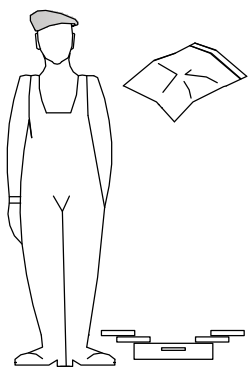
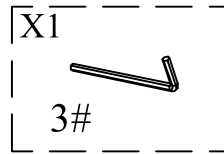
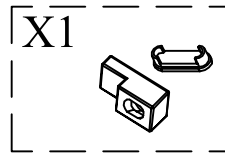
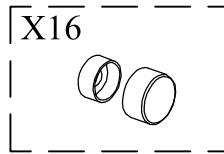
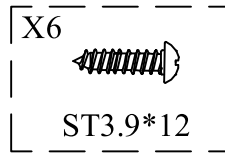
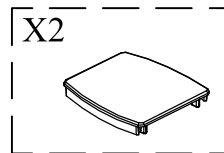
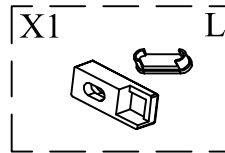
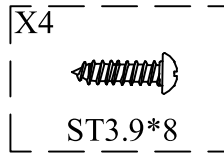
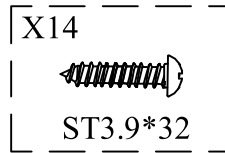
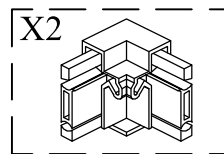
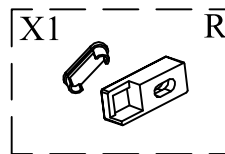
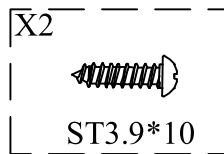
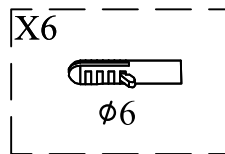
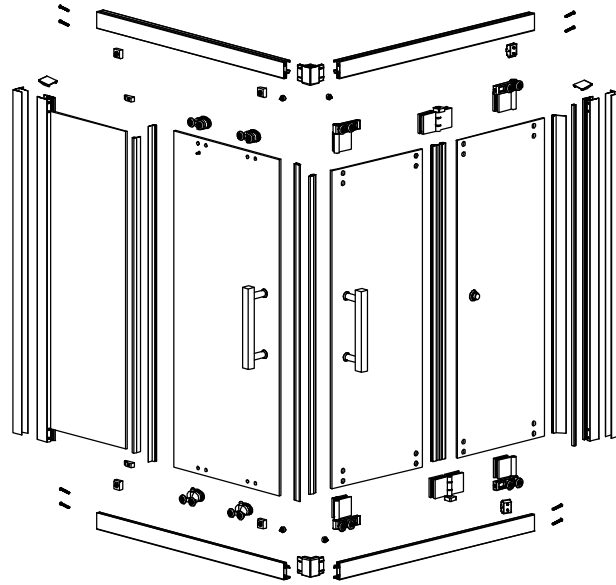
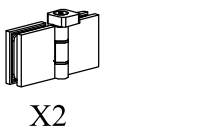
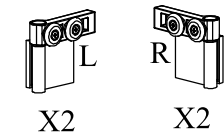
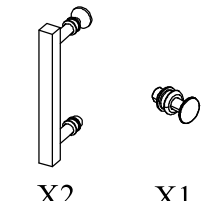
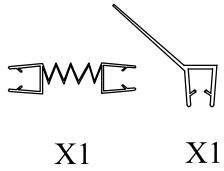
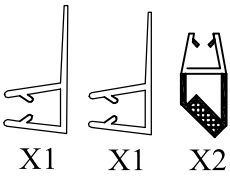
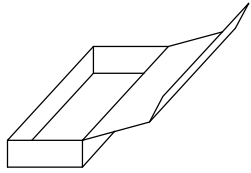

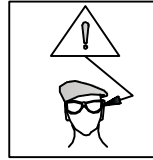
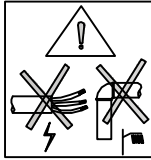
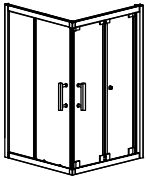

TA16S01

1

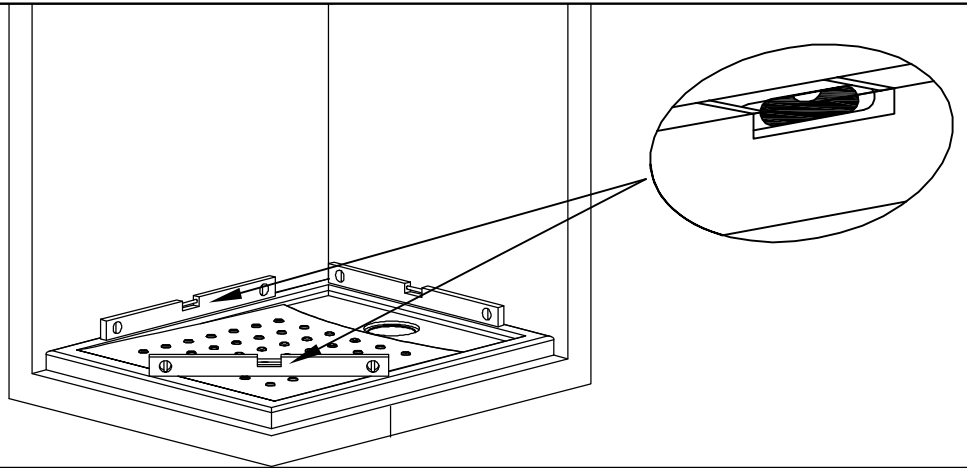
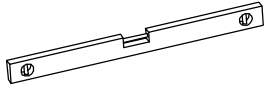

2

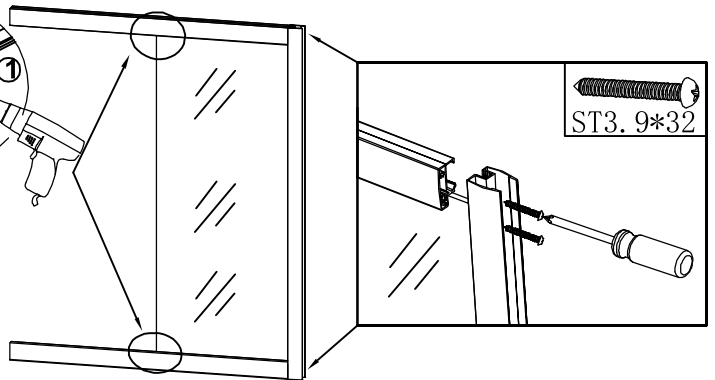
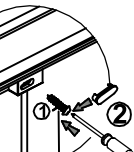
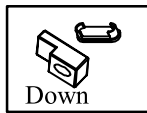
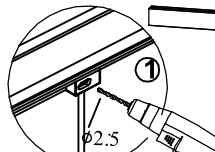
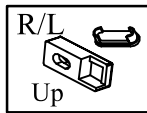

ST3.9*32 X4

ST3.9*10 X2

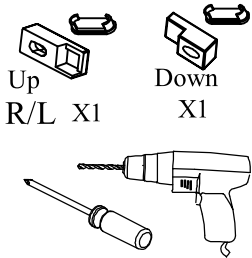

3

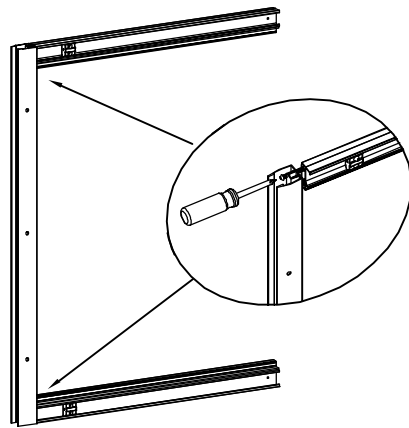

4

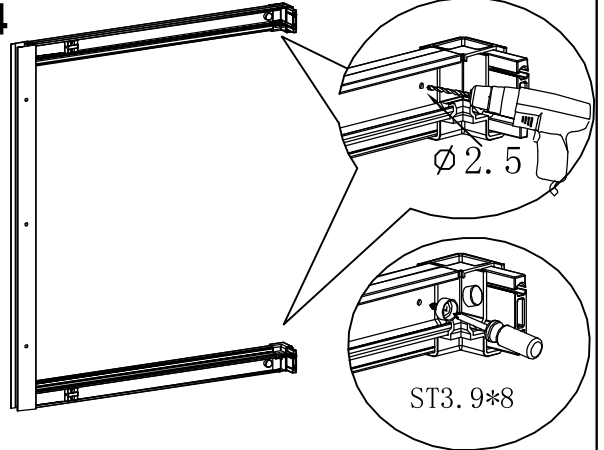

ST3.9*32 X4

ST3.9*8 X2



X2

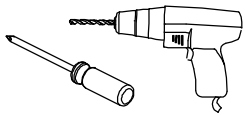

5

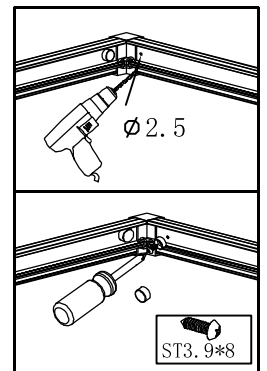
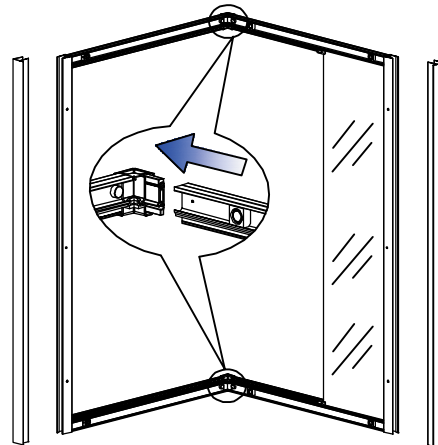
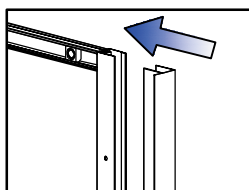
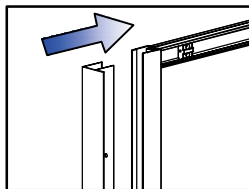

ST3.9*8 X2

X2

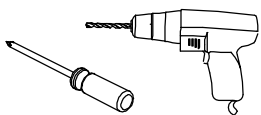

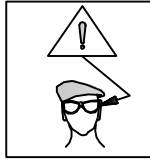
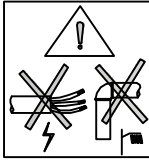
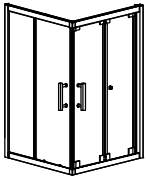

TA16S01

 ST3.9*32 X6

 ST3.9*12 X6

 X12

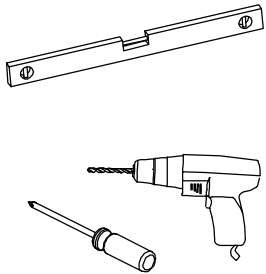

6

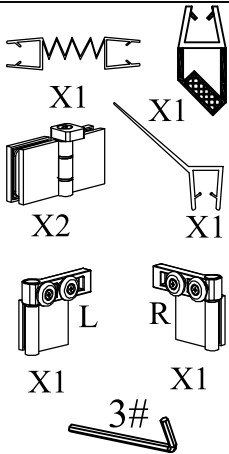
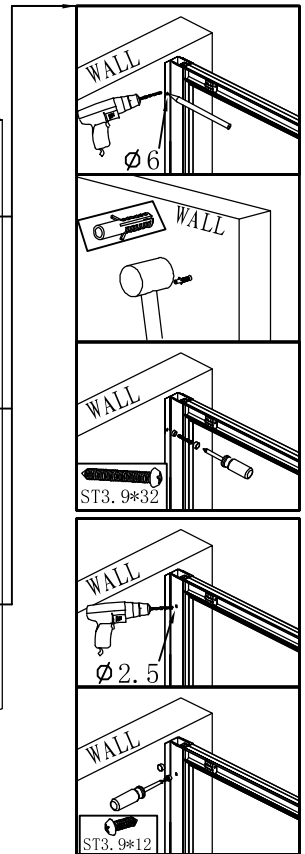
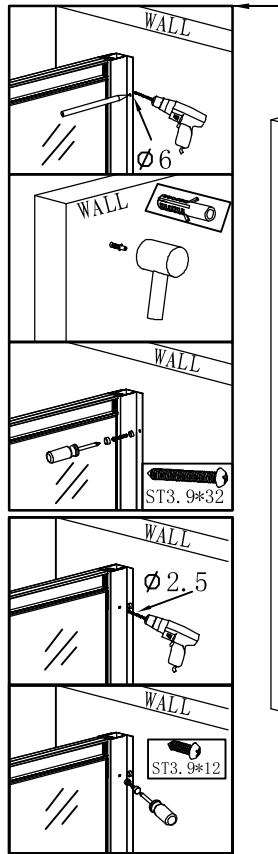

7

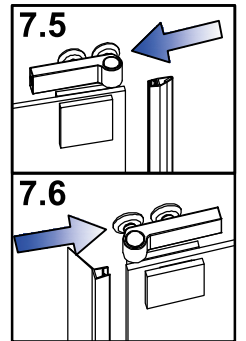
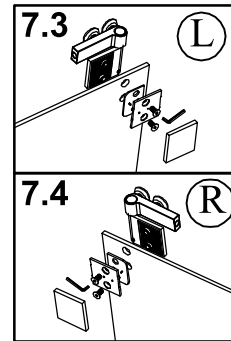
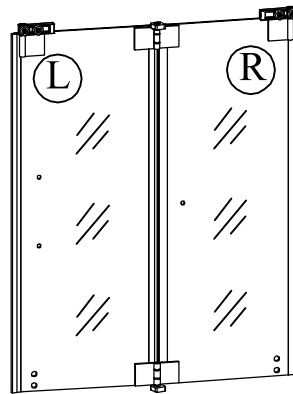
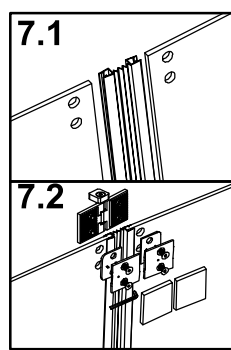

8

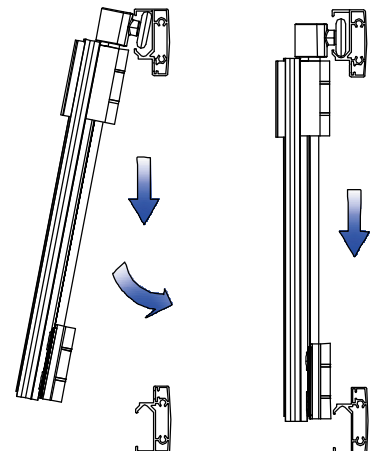
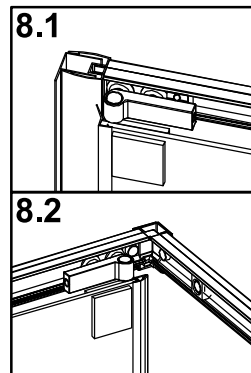
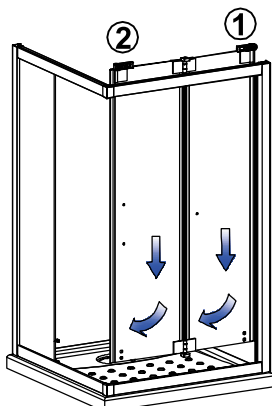

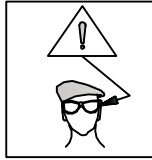
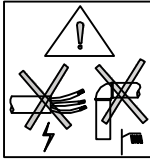
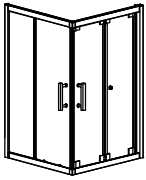

TA16S01



X1



X1

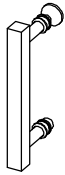

X1



X1

3#

9

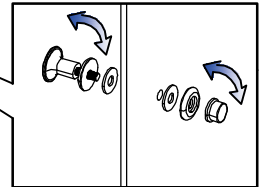
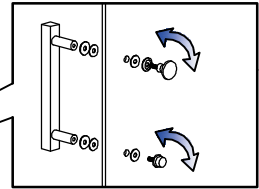
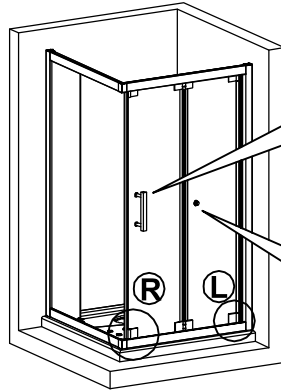
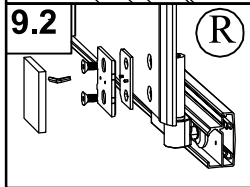
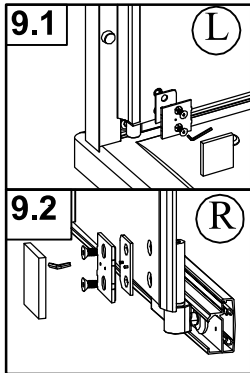

10

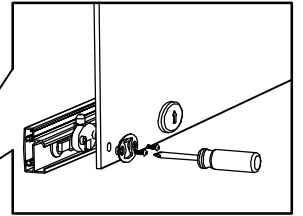
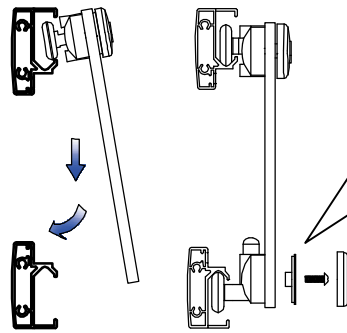
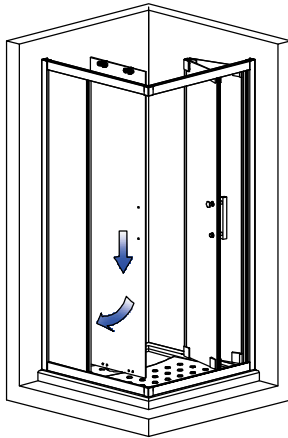

X2

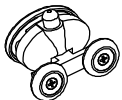

X2

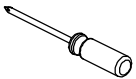

11

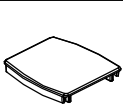
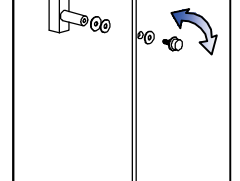
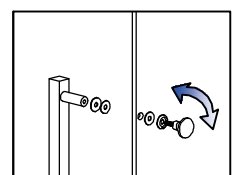
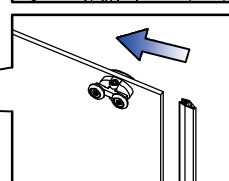
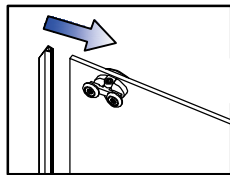
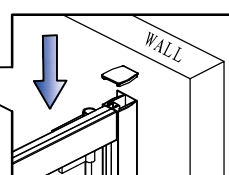
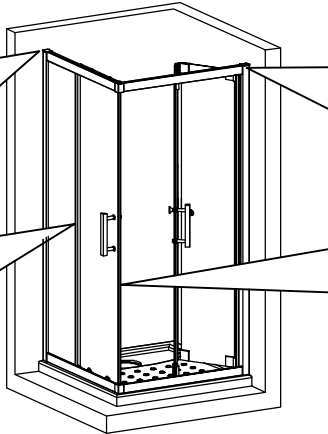
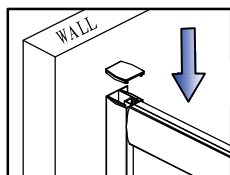

X2



X2



X1



X1



X1

12

