

**E** INSTRUCCIONES DE MONTAJE    **I** INTRUZIONI DI MONTAGGIO  
**F** INSTRUCTIONS DE MONTAGE    **P** INSTRUCAO DE MONTAGEM  
**GB** INSTALLATION INSTRUCTIONS



20  
 COMPLEMENTOS DECORATIVOS DEL  
 BAÑO, S.L.  
 Avda. Can Roqueta 70, 08202 Sabadell, Barcelona,  
 España

DdP nº 2

UNE-EN 14428:2016+A1:2019

Higiene Personal

Endurancia: cumple  
 Estabilidad: cumple  
 Estanqueidad: cumple

DT51S01

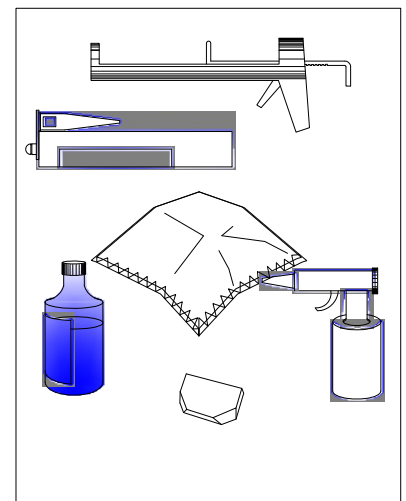
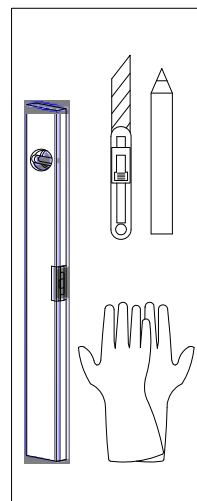
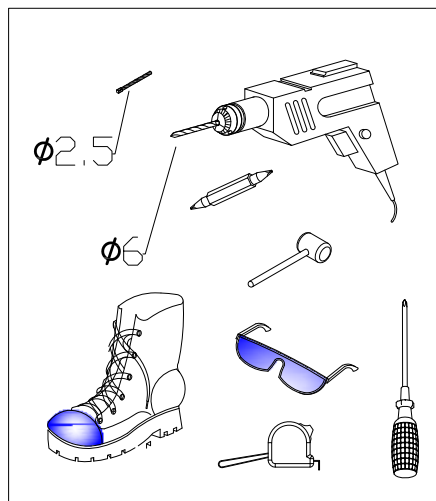
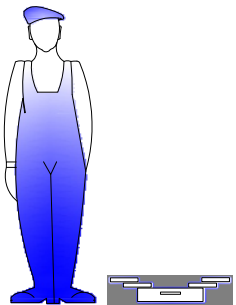
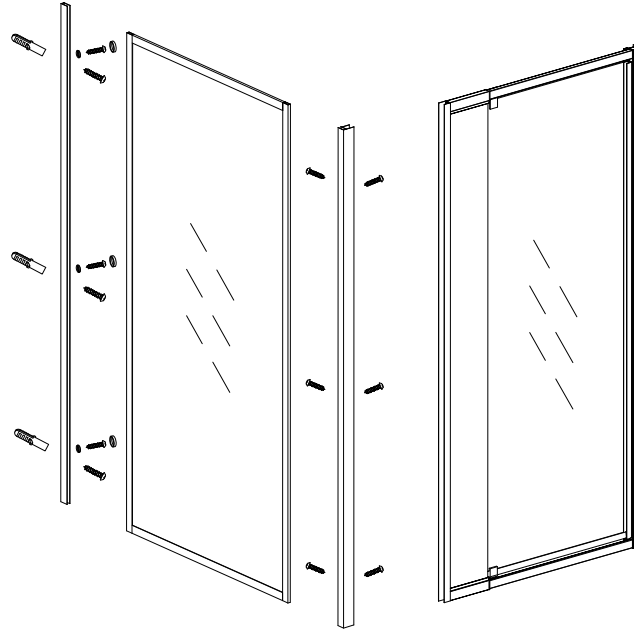
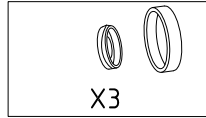
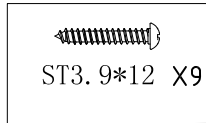
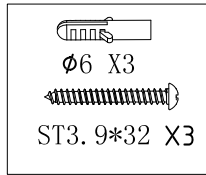
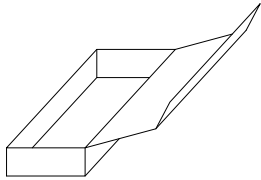

1

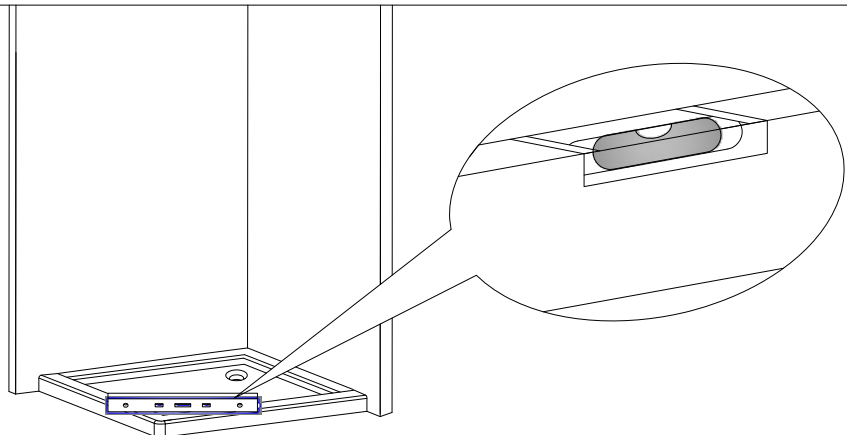

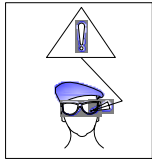
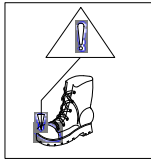
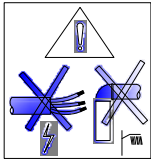
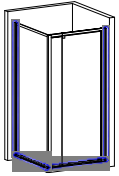

DT51S01

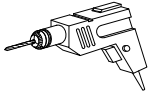

X3  
ST3.9\*12



φ2.5

2

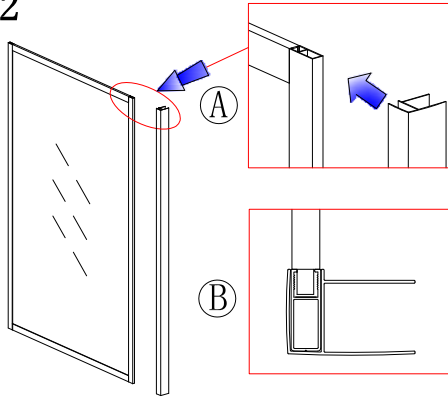

φ2.5 ST3.9\*12

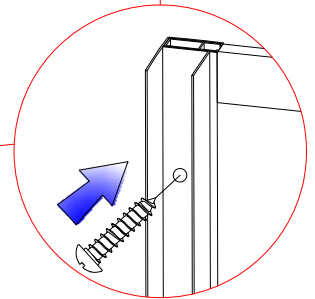

3

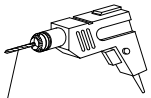
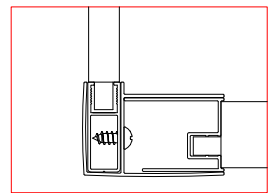
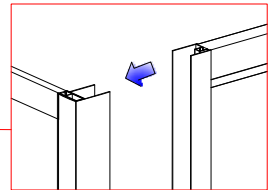
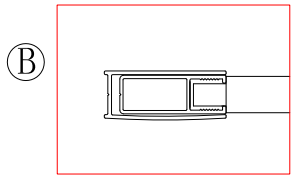
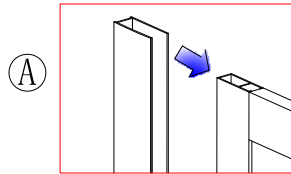

φ2.5 X3  
ST3.9\*12



X3



4



φ2.5 ST3.9\*12

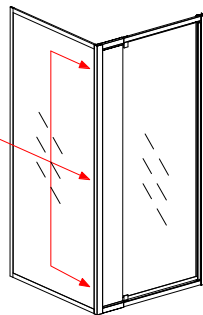
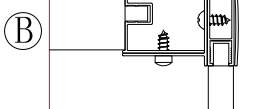
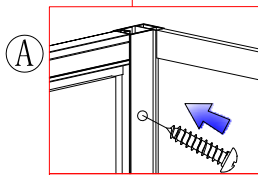

5

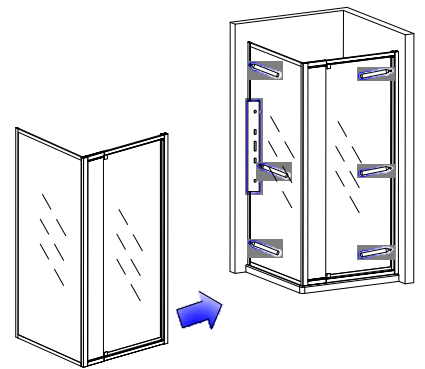

6

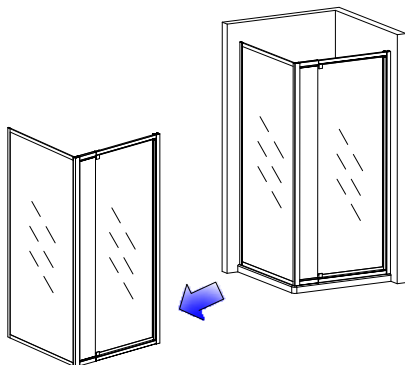

7

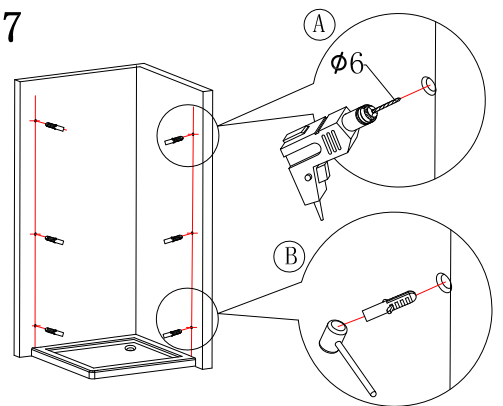

φ6

φ6

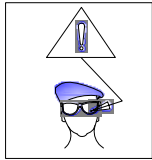
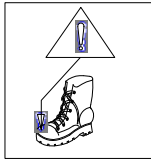
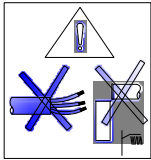
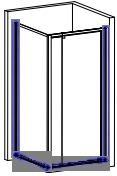

DT51S01

8

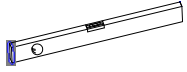

X3  
ST3. 9\*32

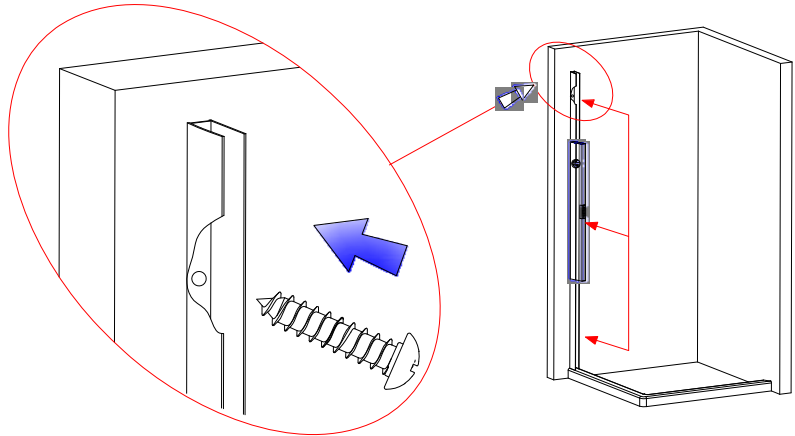
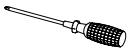

9

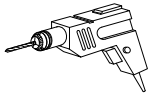

X3  
ST3. 9\*32

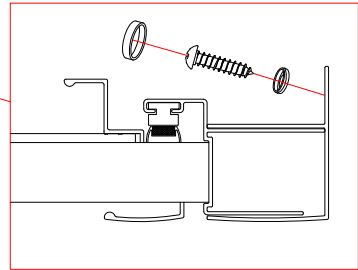
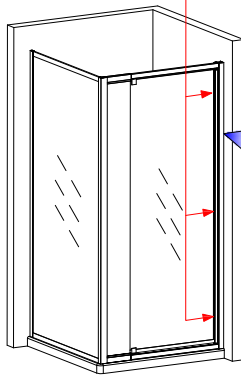
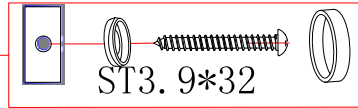
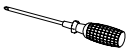
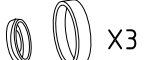

10

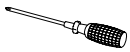
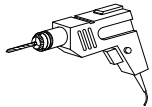

X6  
ST3. 9\*12

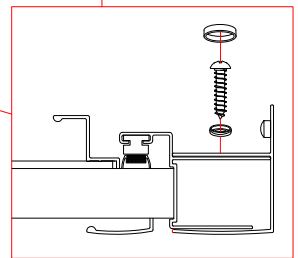
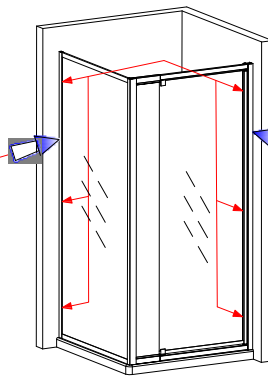
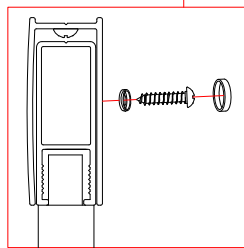
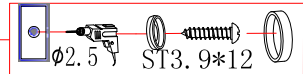
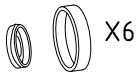

11

