

NOTICE DE MONTAGE
Istruzioni per l'installazione
Assembly instruction

réf. VD 3330.02BN
ref. VD 3330.02BN
ref. VD 3330.02BN

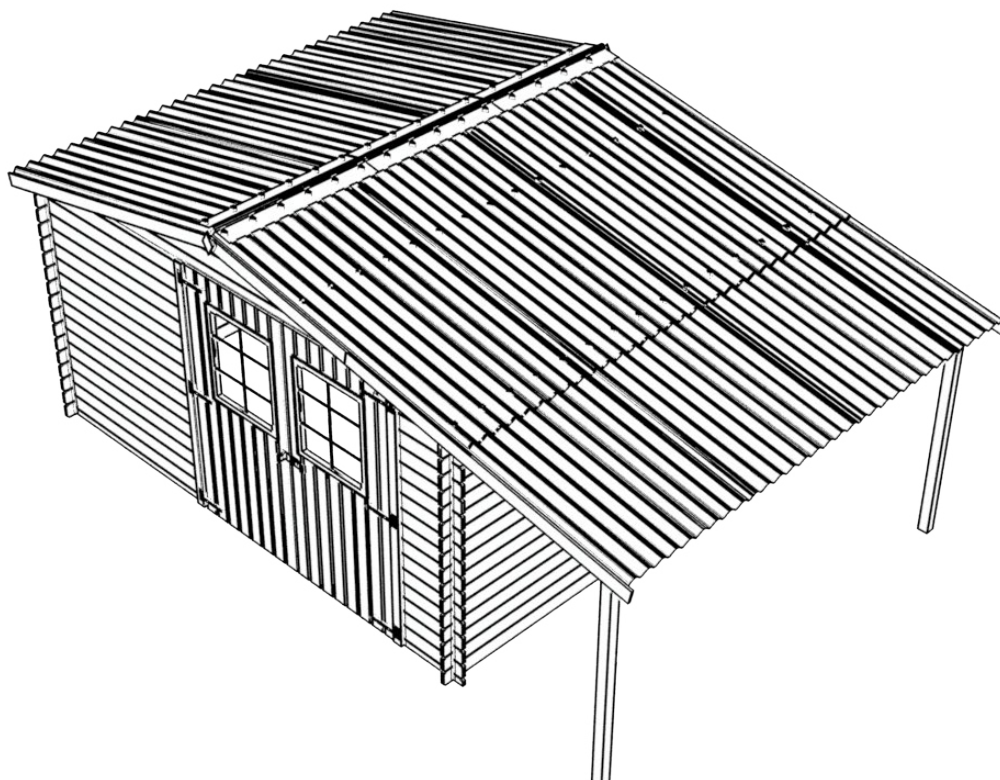

Surf. au sol / Superf. interna netta/ Internal surface : 9,9+3 m²

Surf. hors tout / Superficie totale/ Total surface : 13,52 m²

Pente de toit/ Pendenza tetto/ Roof slope : 13°

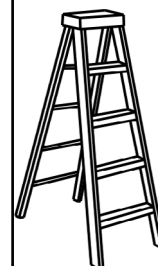
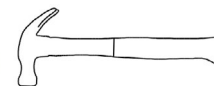

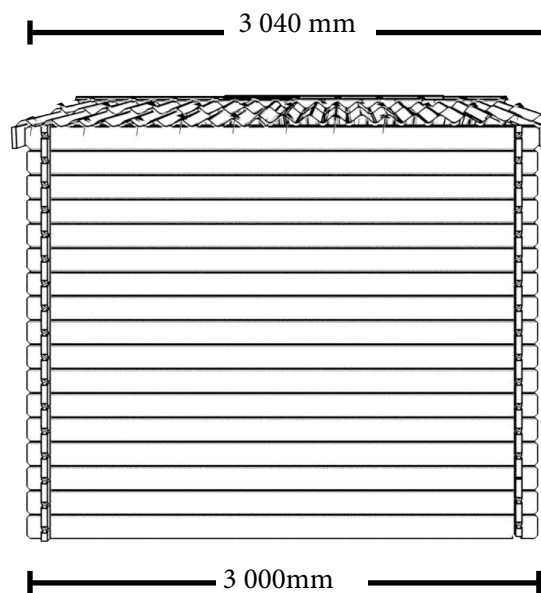
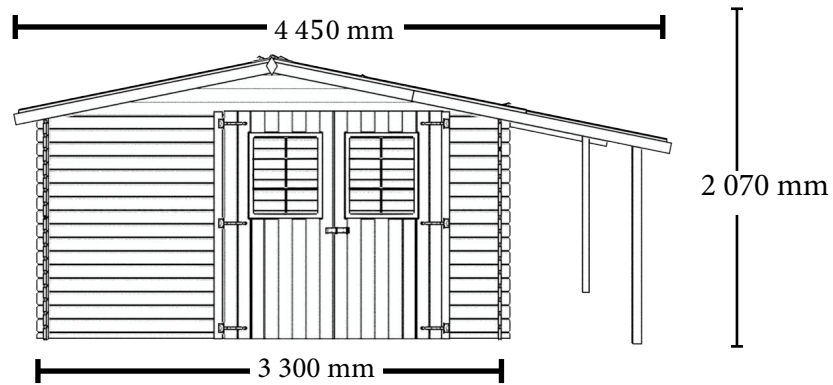

Plan de soubassement VD 3330.02BN

Piano di basamento VD 3330.02BN

Basement plan VD 3330.02BN

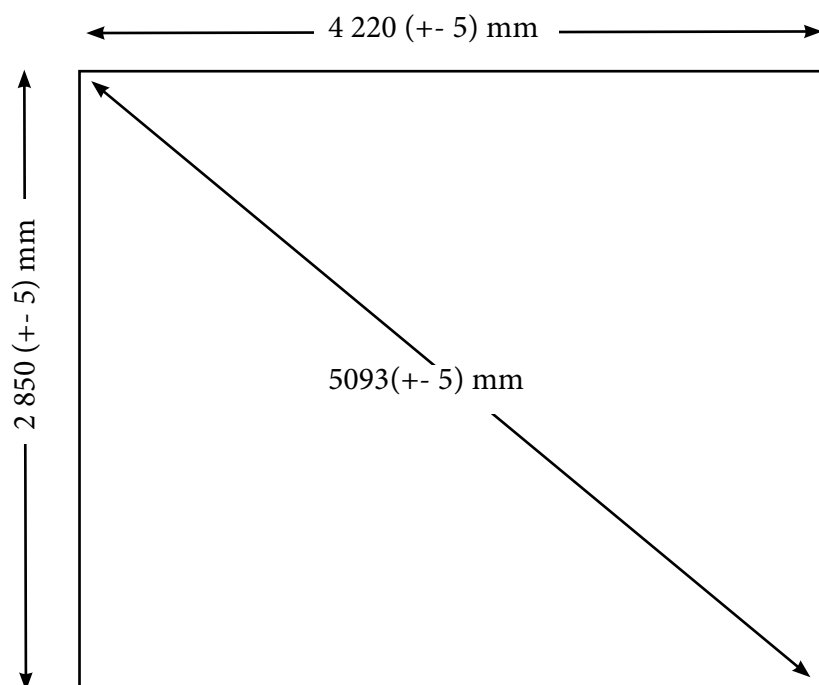





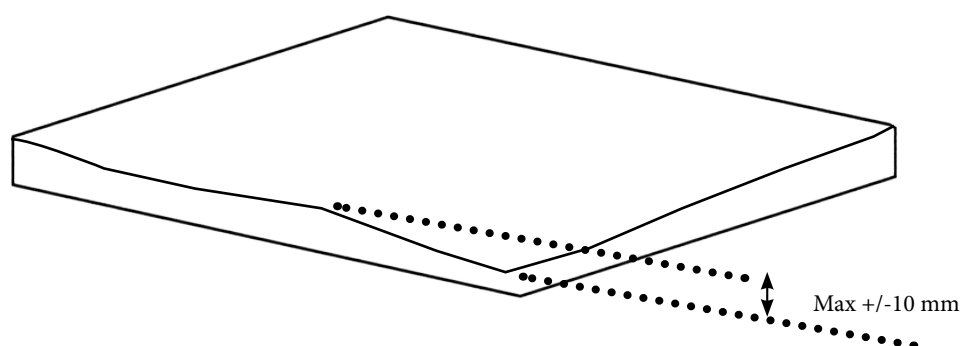

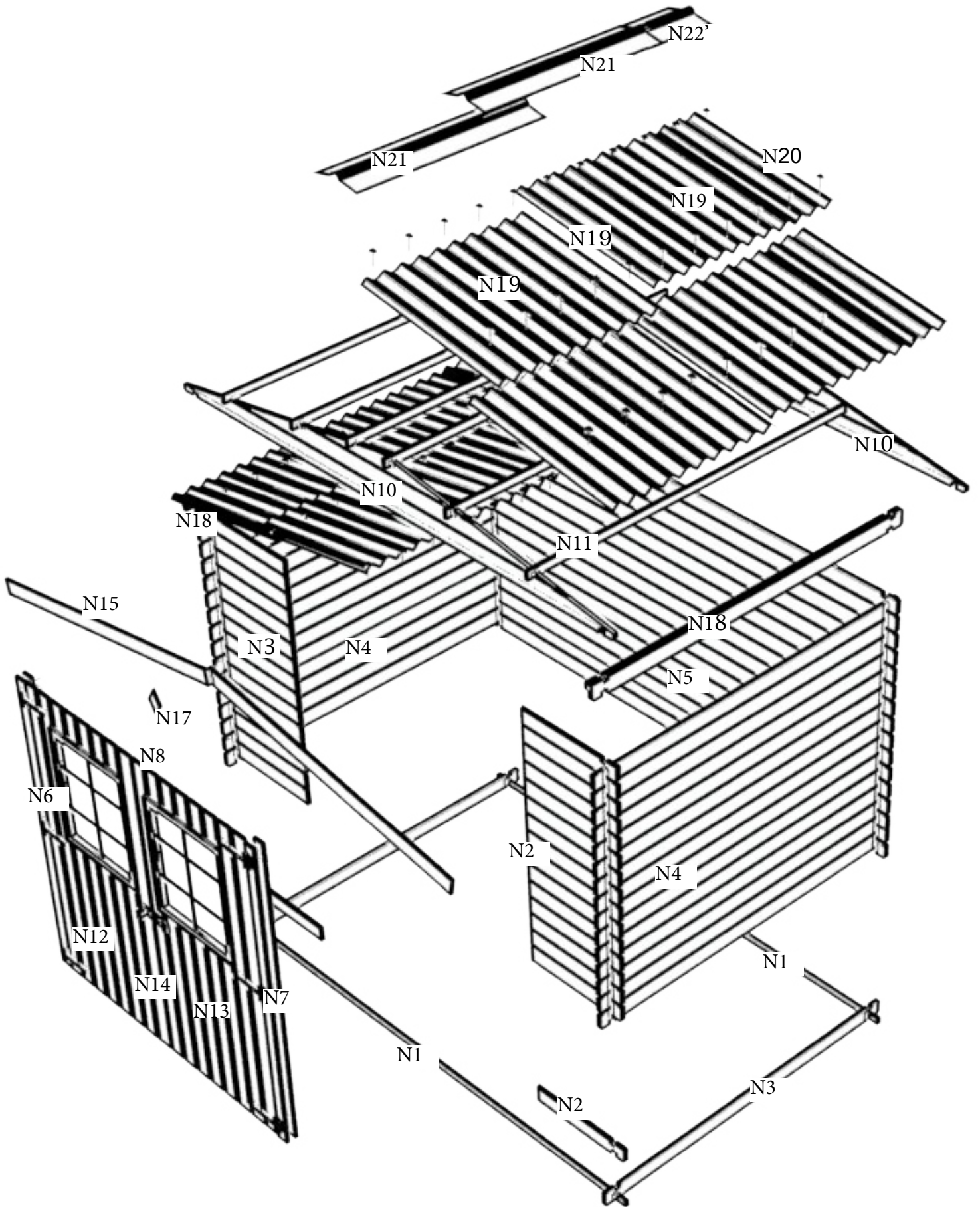





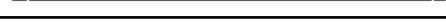

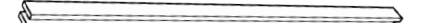
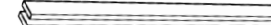









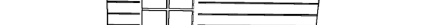





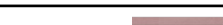
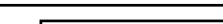
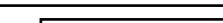

Les dimensions données sur le plan de soubassement sont les dimensions de la dalle béton à réaliser sur un sol parfaitement plat sans aucun autre objet extérieur type mur, clôture ou arbre dans l'entourage de la dalle. Si le produit est implanté près d'un mur, d'une haie ou d'un arbre il est nécessaire de l'éloigner des éléments extérieurs afin de pouvoir facilement le monter et l'entretenir. Nous nous dégageons de toute responsabilité en cas de mauvaise interprétation des dimensions de la dalle.

Le dimensioni del piano di base sono le dimensioni della soletta di cemento da realizzare su un terreno perfettamente piatto, senza alcun altro oggetto esterno, come un muro, una recinzione o un albero in prossimità della soletta. Se il prodotto è installato vicino ad una parete, un recinto o un albero, è necessario distanziarlo adeguatamente, in modo da poterlo facilmente montare e farne la manutenzione. Non ci assumiamo alcuna responsabilità per l'errata interpretazione delle dimensioni della lastra.





N°	REF	DES.	DIM (mm)	QTE	PLAN	OBS	QTE
1	I28.2.3300		3300 x 55 x 28	2			
2	L28.1.1160		1160 x 108 x 28	16			
3	L28.1.450		420 x 108 x 28	16			
4	L28.2.3000		3000 x 108 x 28	32			
5	L28.2.3300		3300 x 108 x 28	16			
6	TLS 1690.28		1690 x 80 x 68	1			
7	TLD 1690.28		1690 x 80 x 68	1			
8	EST 1680.40.20		1680 x 40 x 20	1			
9	ES200.70		200 x 70 x 20	2			
10	F28.3300.300		3300 x 300 x 48	2			
11	GL 3000.70		3000 x 70 x 40	6			
12	UD1690.800		1690 x 800 x 48	1			
13	US1690.800		1690 x 800 x 48	1			
14	DPV810.70		810 x 70 x 16	2			
15	DSF1830.90		1830 x 90 x 20	2			
16	DSF2780.90		2780 x 90 x 20	2			
17	R150.90		150 x 90 x 20	2			
18	LSS28.2.3000		3000 x 108 x 48	1			
	LSD28.2.3000		3000 x 108 x 48	1			
19	OND1795.860		1795 x 860 x 30	8			
21	FOND480.1000		1000 x 480 x 30	3			
22	FOND480.500		500 x 480 x 30	1			
23	POT1500		1500 x 70 x 70	3			
24	GLB3000.40		3000 x 40 x 40	2			
26	CHV1109		1109 x 90 x 40	3			
27	GP2800.40		2800 x 40 x 40	1			
28	DLB3000		3000 x 70 x 20	1			
29	Vis 4 x 45		4 x 45	82			
30	Vis 3,5 x 35		3,5 x 35	10			
31	Clous L80		80	16			
32	Vis 3,0 x 30		3 x 30	10			
33	Clous L16			40			

34	Verrou a douille		80x 60 x2	2		
35	Pentures		80x 1	6		
36	Clous à tête moulée			190		
37	Loquet			1		

Demande sav

A compléter impérativement pour toute demande SAV et à envoyer par mail à sav@foresta.fr + photo des pièces abîmées (To be completed imperatively + Photo of damaged parts)

	VD 3330.02BN	MAGASIN (STORE)	
		NOM (NAME) CLIENT	
		<u>Colis(package) n° :</u> PRENOM(PRE.) CLIENT	
		TEL.	

38	Vis 5,0 x 60	5 * 60	14
39	OND664.860	664x860x30	
440	OND498.860	498x860x30	4

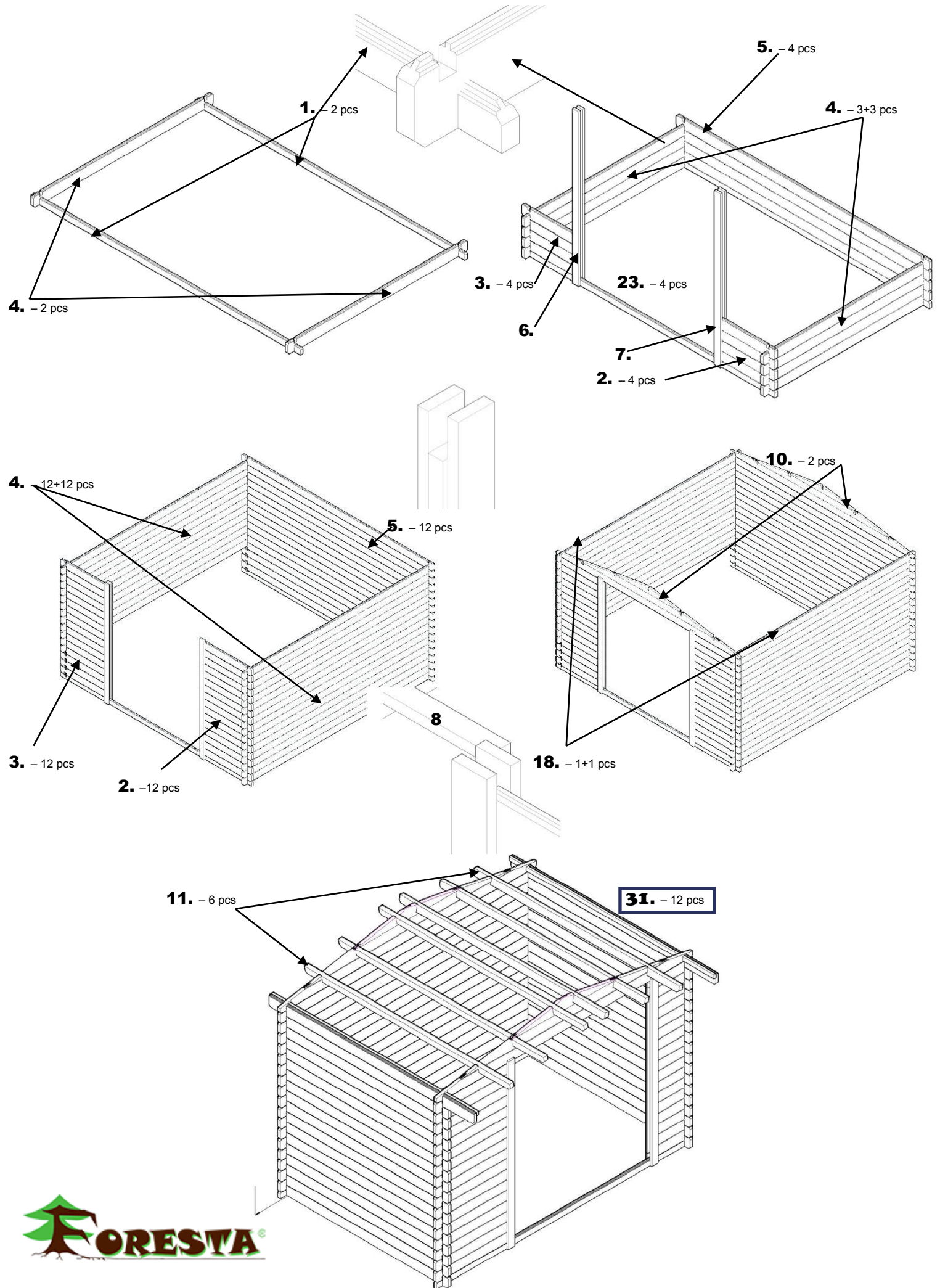

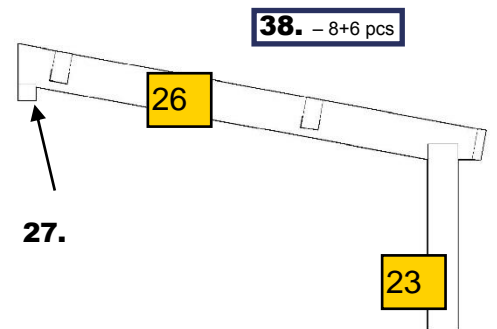
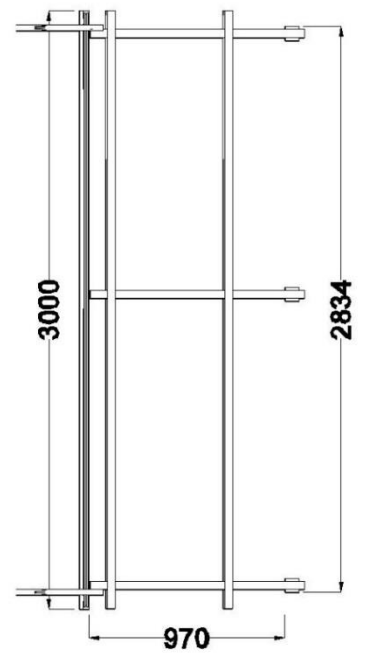
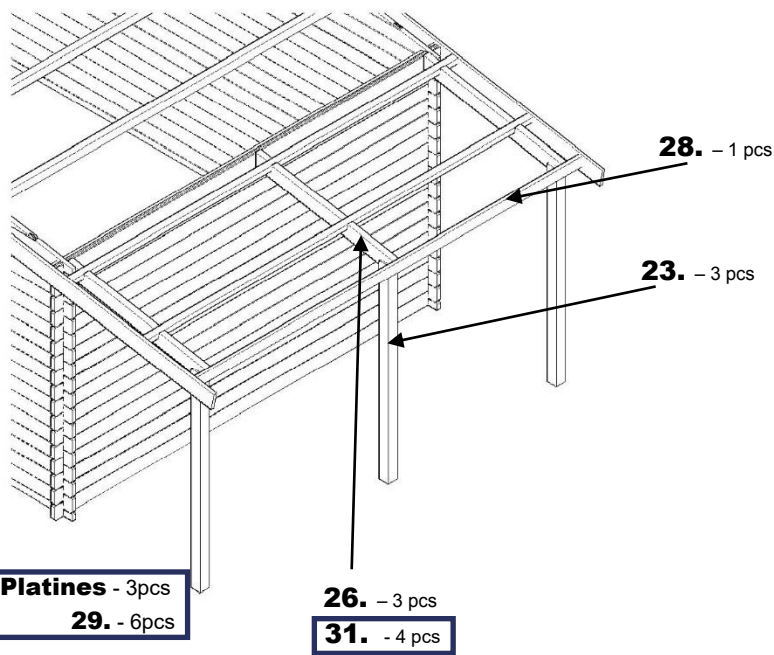

Installer les décorations n °15+16 puis commencer à positionner les plaques ondulées en commençant par l'avant et l'arrière en fixant les plaques sur les décorations n °15+16 avec des clous n ° 33.

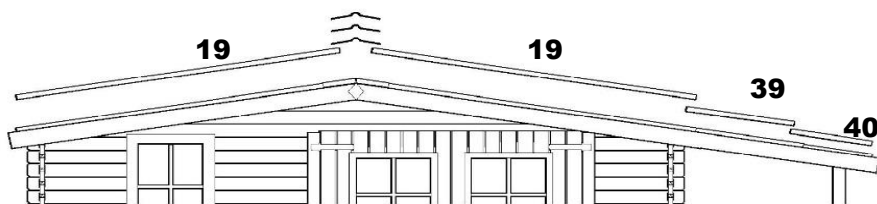

Les plaques ondulées bitumées se touchent au sommet de la maison

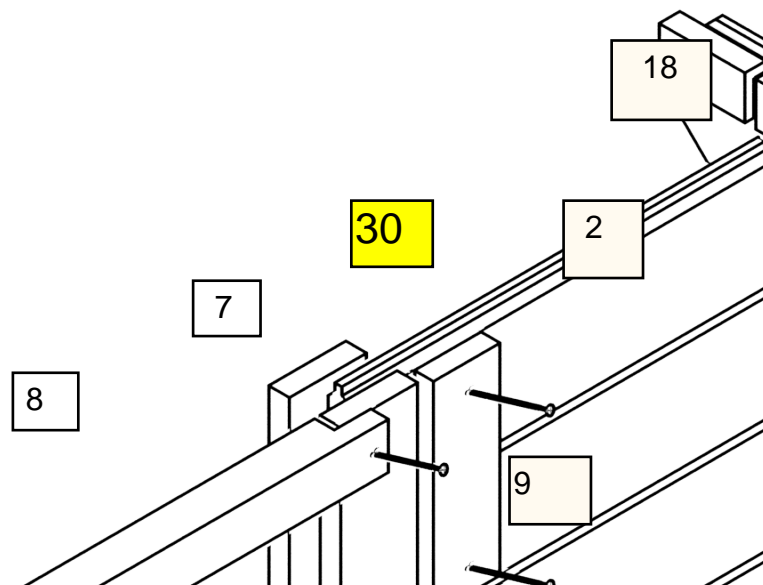
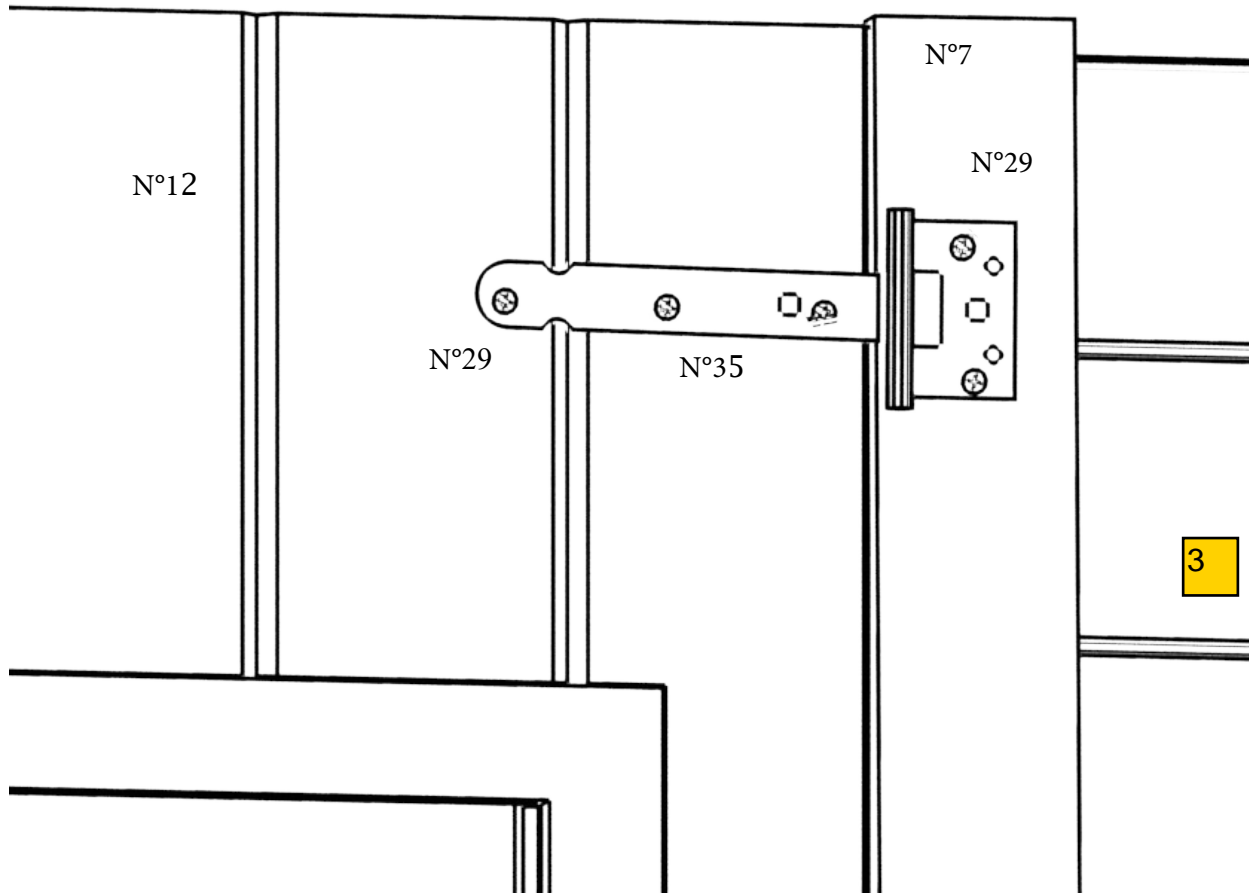

N37= 1 pc.
N29 = 6 pc.

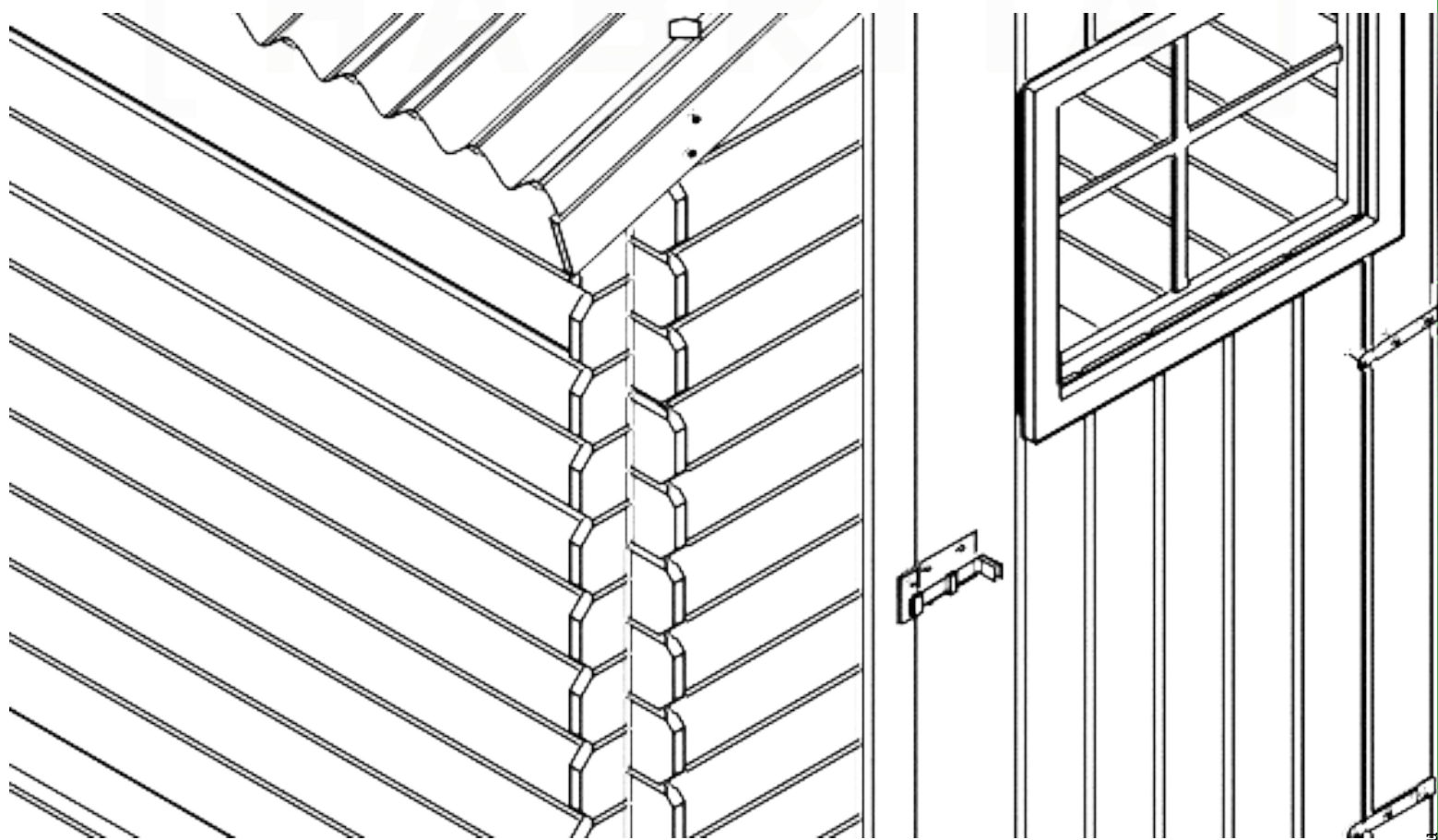
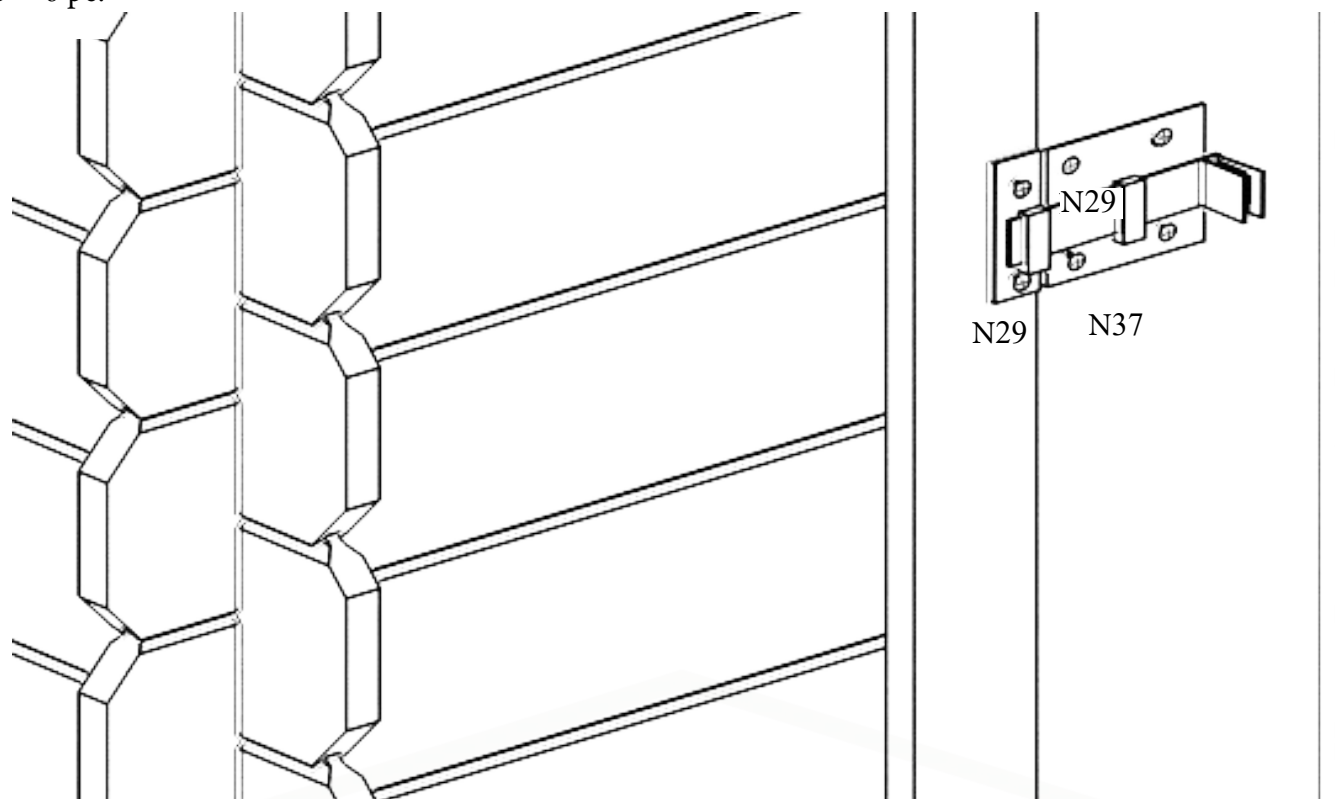

34 = 2p
30 = 4p
32 = 4 p

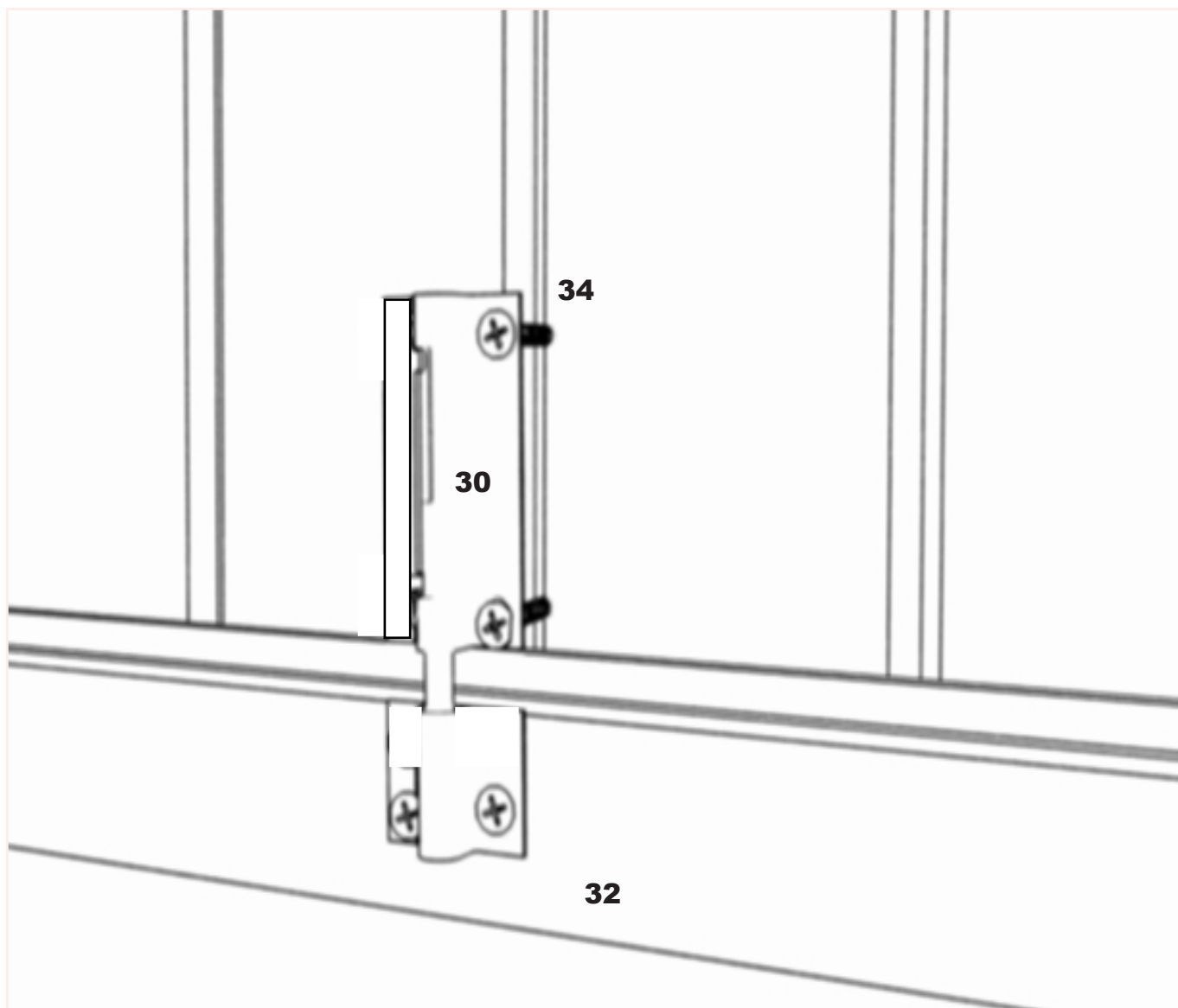

14 = 2p
32 = 6 p

