

MODELO 400

CARACTERÍSTICAS HOJAS	MATERIAL	TIPO	VALORES
ALMA	Nido de abeja	Alveolar	27,5mm
BASTIDOR	Tablero de Fibras	Densidad > 650 kg/m ³	27X35mm
ALAMBOR		Sí	
CANTEADO		2 Lados	
ACABADO	Lacado	Dimoldura	Blanco

	ALTO	ANCHO	GRUESO
MEDIDAS	2000	650 / 700 / 750 / 800 / 850 / 900	35

	OPCIONES
VIDRIERA	4VR
CANAL CORREDERA	No

CARACTERÍSTICAS CERCOS	MATERIAL	TIPO	VALORES
CERCO AJUSTABLE	Tablero de Fibras	Hidrófugo	70 x 28
ACABADO	Papel	8L	Blanco R2BL008L
BURLETE	QL	QL 45	Blanco

CARACTERÍSTICAS TAPETAS	MATERIAL	TIPO	VALORES
	Tablero de Fibras	Hidrófugo	70x15/12
ACABADO	Papel	8L	Blanco

CARACTERÍSTICAS HERRAJES	MARCA	TIPO	VALORES
PICAPORTE	Dimoldura 279/50	Reversible llave Borja	1
BISAGRAS	75x75	Reversible	3

CARACTERÍSTICAS MECANIZADO	
MECANIZADO TALADROS CARA PUERTA (manilla y llave)	Si (taladro manilla y llave)



MECANIZADO PUERTA

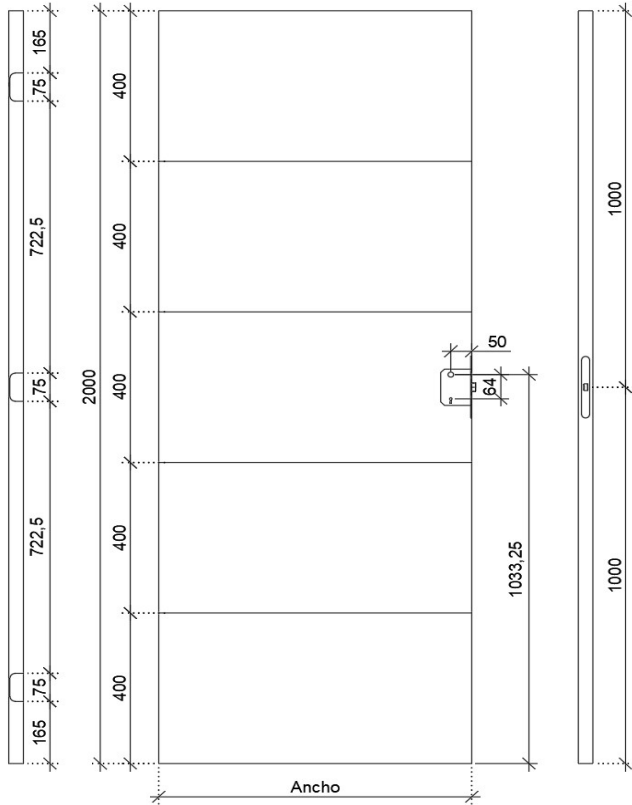

CERRADURA

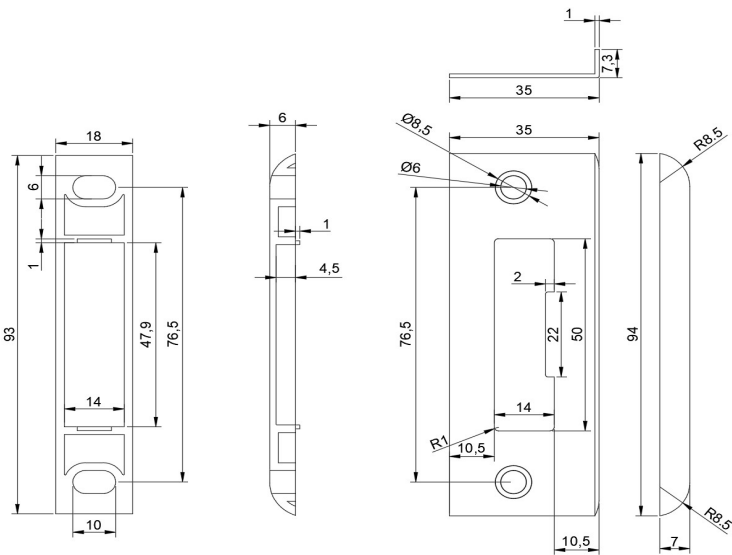
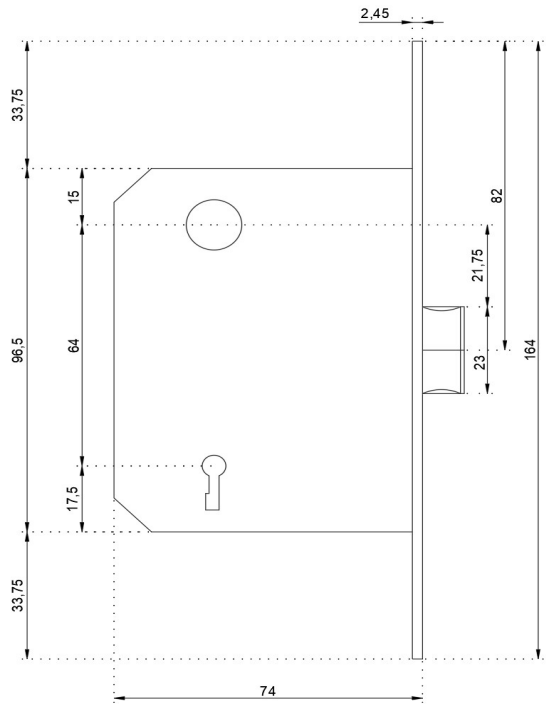

Detalle cerradero

PATAS

CERCO CERRADERO

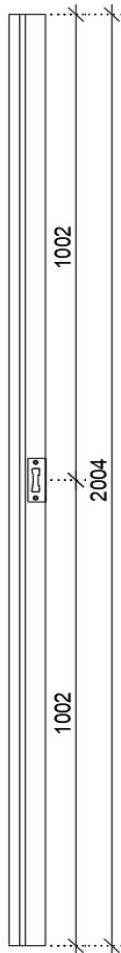

CERCO BISAGRAS

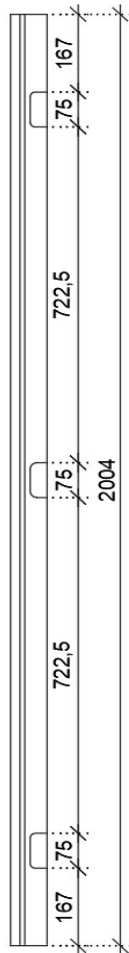

BISAGRA

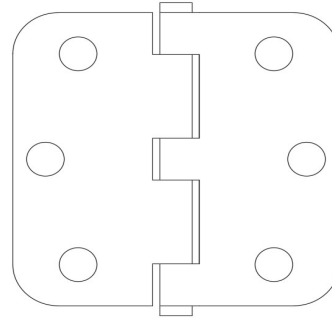

CERCO

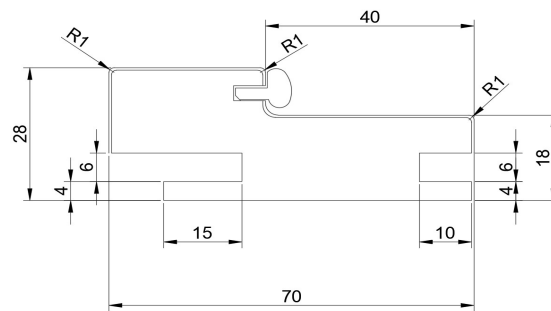

CABEZALES

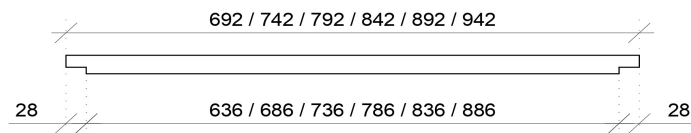

MODELO 400

TAPETA FIJA

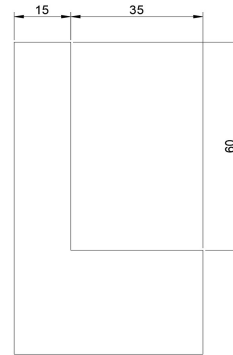
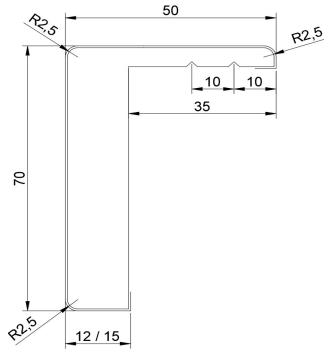

TAPETA EXTENSIBLE

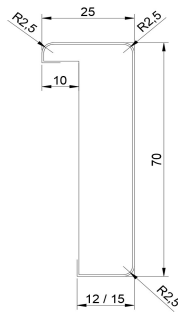

	Patas	Cabezas
Medidas	2082	672 / 722 / 772 / 822 / 872 / 922

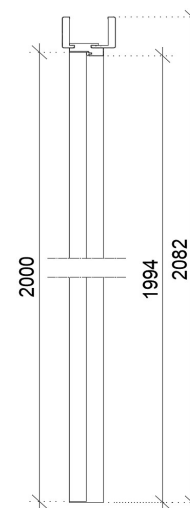
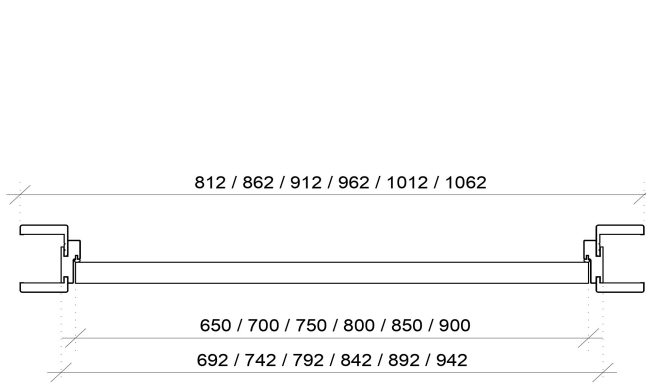

TALADROS MECANIZADO CERCO

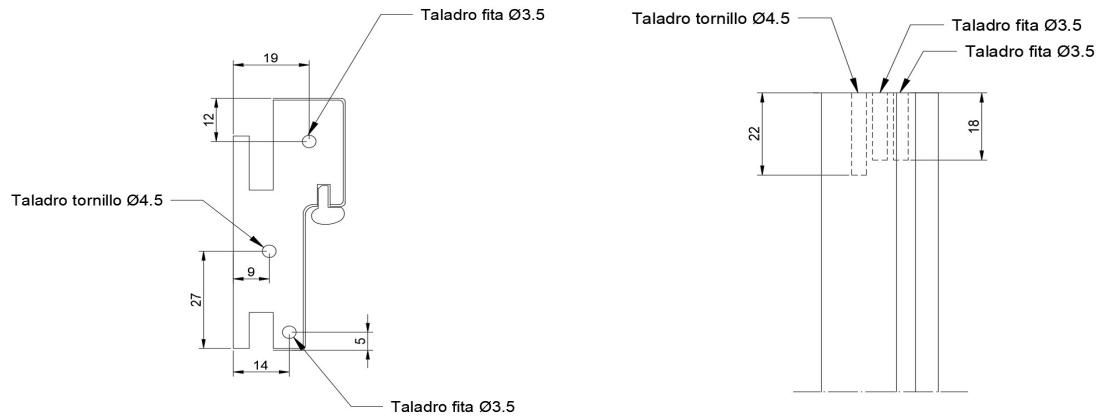

TALADROS MECANIZADO CABECERO

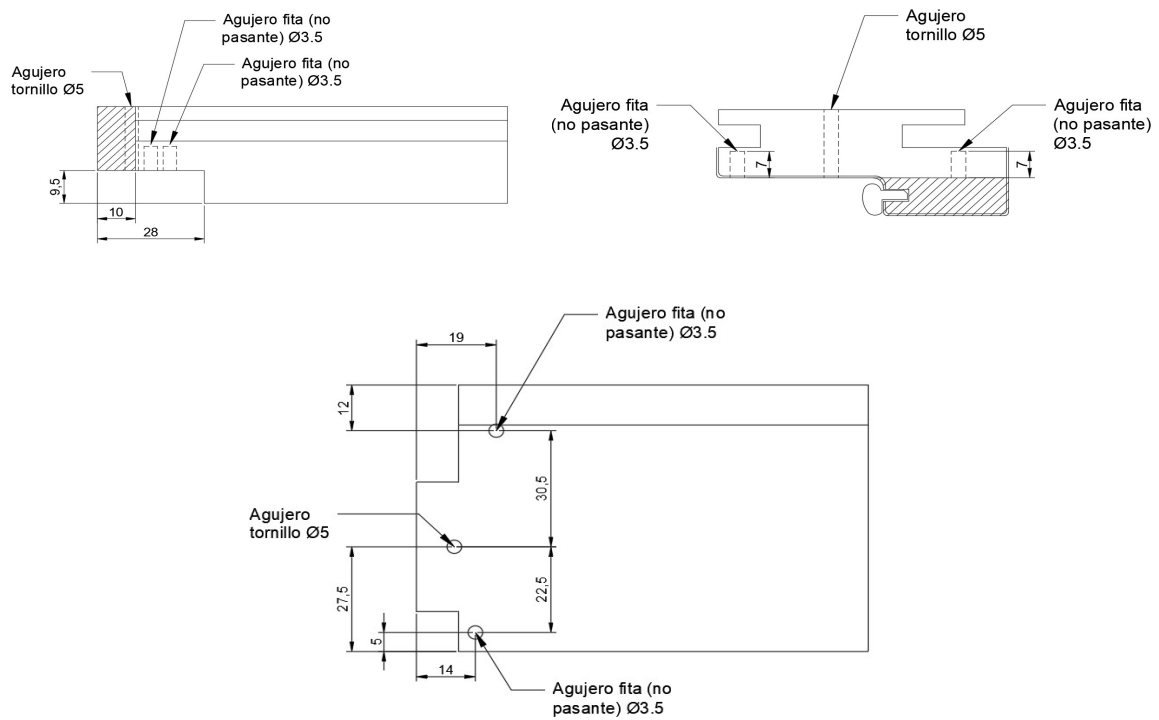

MODELO 400

UBICACIÓN	MÉTRICA	CANTIDAD
CERCO-BISAGRA	4 x 16	9 ud
PUERTA-BISAGRA	4 x 30	9 ud
PETACA	4 x 30	2 ud
CERRADERO	3,5 x 16	2 ud
CABECERO	5 x 50	2 ud

