

Item	Component code	Dimension	Qty
A	LEG	P800, L149	4
B	LEG	P800, L745	2
C	SUPPORT PIECE	45x60x4	4

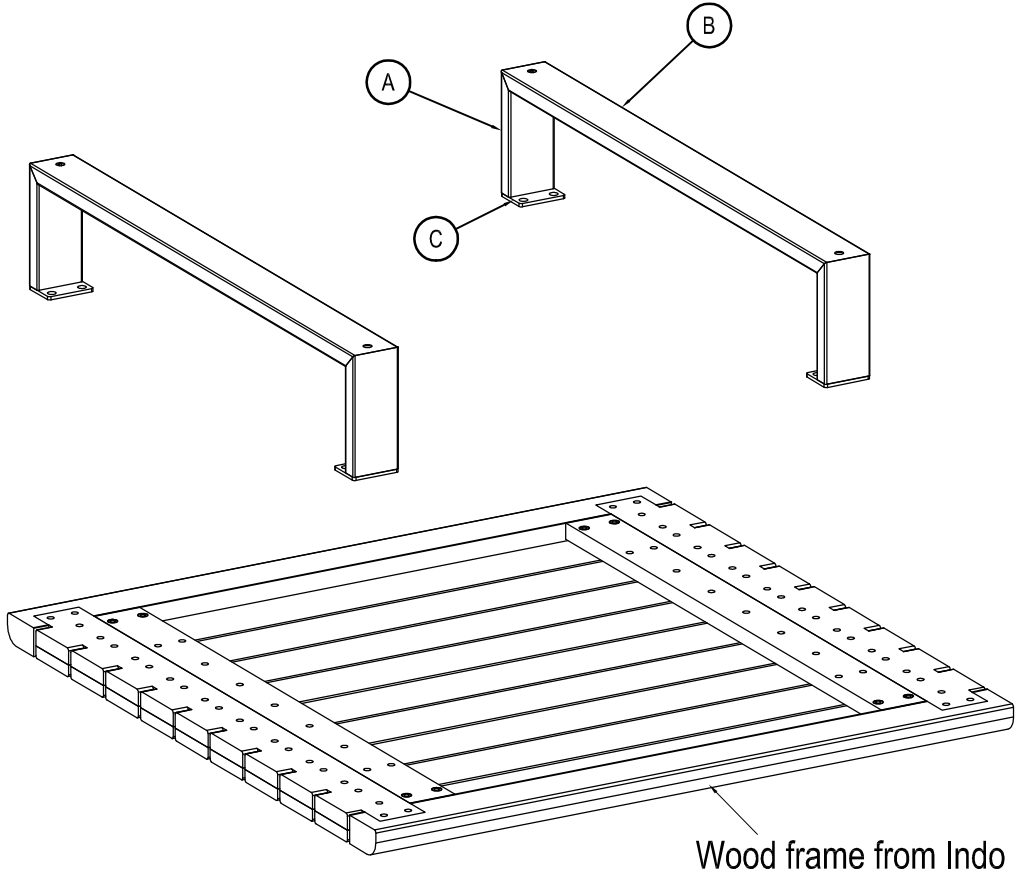

Wood frame from Indo

Rev	NAME	DATE
01	SCANCOM	10-03-24
02		
03		
04		
05		
06		



ADEO - 135, rue Sadi Carnot
CS 00001 - 59790 RONCHIN
FRANCE

MATERIAL/FINISHING:
ALU, TEAK

GENERAL TOLERANCES:
LINEAR:
ANGULAR:

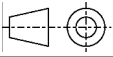

TITRE: LOW TABLE FOR CORNER SOFA SET
NATERIAL 5P ALU FSC TEAK BEIGE

No. DE PLAN: 3276007784619

A3

REVISION

ECHELLE: 1:1 (Scale can be adapted) Dimensions in mm FEUILLE 1 SUR 1

Item	Component code	Qty
1	Foot Ø23x30, MM (M6)	4
2	F-Bolt 6x20, P-HEX, SS	8
3	Insert Rivet 6x16, SS	4

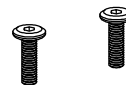
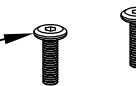
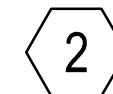
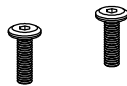
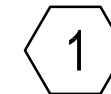

GENERAL TOLERANCES:
LINEAR:
ANGULAR:

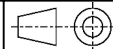

Rev	NAME	DATE
01	SCANCOM	10-03-24
02		
03		
04		
05		
06		

Naterial
ADEO - 135, rue Sadi Carnot
CS 00001 - 59790 RONCHIN
FRANCE

TITRE: LOW TABLE FOR CORNER SOFA SET
NATERIAL 5P ALU FSC TEAK BEIGE

No. DE PLAN 3276007784619

A3

MATERIAL/FINISHING: ALU, TEAK

REVISION

ECHELLE: 1:1 (Scale can be adapted) Dimensions in mm FEUILLE 1 SUR 1