

EAN : 3276007818055
Adeo key : 91468691

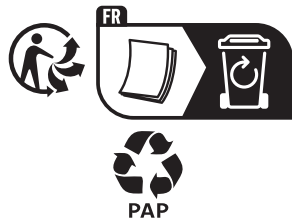
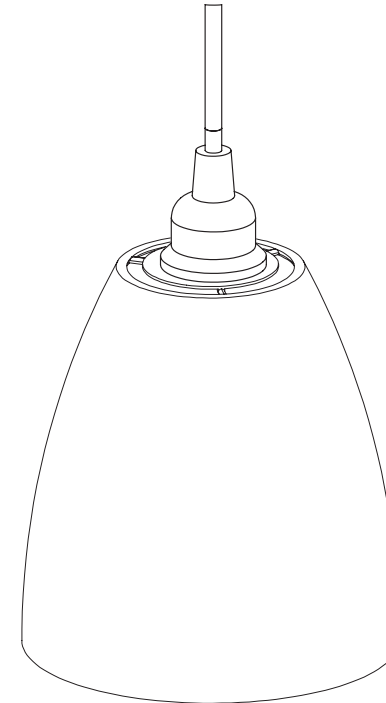

Made in Spain
Країна походження: Іспанія

EU - ADEO Services - 135 Rue Sadi Carnot - CS00001 - 59790 RONCHIN - FRANCE
www.product-regulatory.adeoservices.com

UA Виробник: ТОВ "Адео Сервісез С.А.", вул. Саді Карно, CS 00001, 59790 Роншен, Франція.
Імпортёр: ТОВ "Леруа Мерлен Україна", 04201 Україна, м.Київ, вул. Полярна 17А, +380 44 498 46 00. Імпортёр приймає претензії від споживачів щодо товару, а також проводить його ремонт, технічне і гарантійне обслуговування

BR LEROY MERLIN COMPANHIA BRASILEIRA DE BRICOLAGEM
CNPJ: 01.438.784/0001-05
Rua Pascoal Pais, nº. 525, 6º andar cj 61 a 64, Vila Cordeiro, São Paulo - SP. CEP: 04581-060
CALM (Central de Atendimento Leroy Merlin) Capitais
4020-5376 Demais Regiões 0800-0205376

ZA Imported by Adeo South Africa (PTY) LTD T/A Leroy Merlin, Hosted in Leroy Merlin Fourways Store 35 Roos Street, Witkoppen Ext 97, Sandton, 2191 Johannesburg, Gauteng, South Africa.
Tel: +27 10 493 8000 Email: contact@leroymerlin.co.za.



2/2

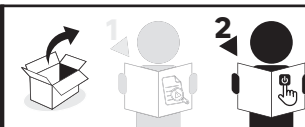

2024-05-V01

FR - Manuel d'Instructions
ES - Manual de Instrucciones
PT - Manual de Instruções
IT - Manuale di Istruzioni
EL - Εγχειρίδιο Οδηγιών
PL - Instrukcja Obsługi

UA - Інструкція з Експлуатації
RO - Manual de Instrucțiuni
BR - Manual de Instrução
NL - Handleiding
DE - Anleitung Handbuch
EN - Instructions Manual

*Année de garantie / años de garantía / Ano de garantia / Anno di garanzia / Έτος εγγύησης / Rok gwarancji / Гарантія років / Anul de garanție / Anos de garantia / Garantiejaar / Jahr der Garantie / Year of guarantee

**réparable / reparabile / reparável / riparabile / διορθώσιμος / naprawiany / ремонтний / reparabil / reparaturfähig / reparável / herstelbaar / reparierbar / repairable

3

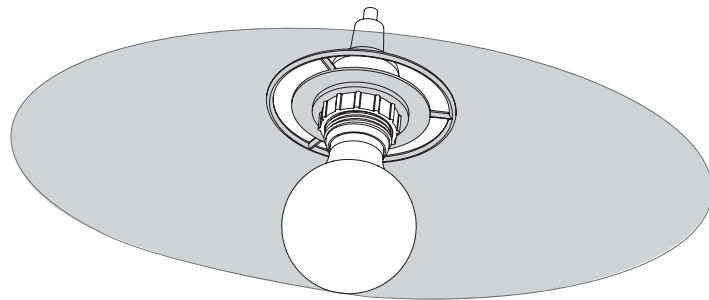

















FR : assemblage / ES : ensamblaje / PT : montagem / IT : assemblaggio / EL : συναρμολόγηση / PL : montaż / UA : збірка / RO : asamblare / BR : montagem / NL : samenstelling / DE : Montage / EN : assembly



FR : Utilisation / ES : Uso / PT : Utilização / IT : Utilizzo / EL : Χρήση / PL : Użycie / UA : Використання / RO : Utilizare / BR : Utilização / NL : Gebruik / DE : Verwendung / EN : Use

FR : CARACTÉRISTIQUES TECHNIQUES / ES : CARACTERÍSTICAS TÉCNICAS / PT : CARACTERÍSTICAS TÉCNICAS / IT : CARATTERISTICHE TECNICHE / EL : ΤΕΧΝΙΚΑ ΧΑΡΑΚΤΗΡΙΣΤΙΚΑ / PL : CECHY TECHNICZNE / UA : ТЕХНІЧНІ ХАРАКТЕРИСТИКИ / RO : CARACTERISTICI TEHNICE / BR : CARACTERÍSTICAS TÉCNICAS / NL : TECHNISCHE KENMERKEN / DE : TECHNISCHE MERKMALE / EN : TECHNICAL SPECIFICATIONS



 A1.	 E27	 A3.	 A6.	 110-240V A7.	 50/60Hz A9	 A13.	 A16.
 A17.	 A19.	 A20.	 A24.	 A33.	 E1.		
 T3.		 T7.					

4

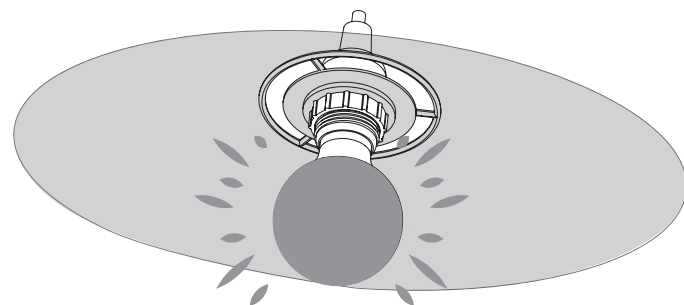
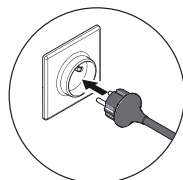



A

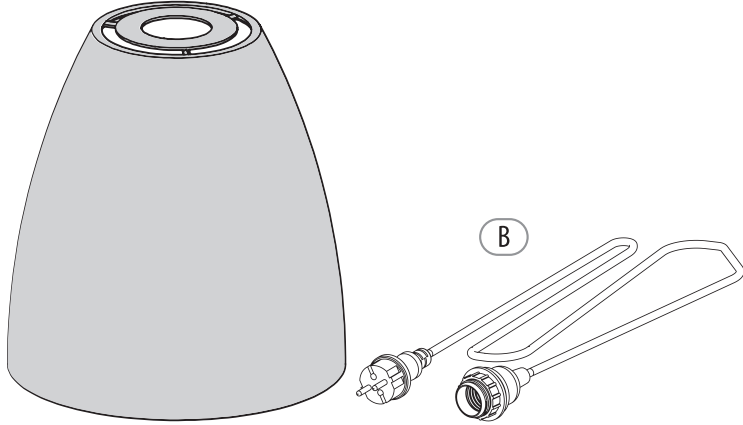

B



15W Max

Ø 125 mm



E27

Max 170 mm



1

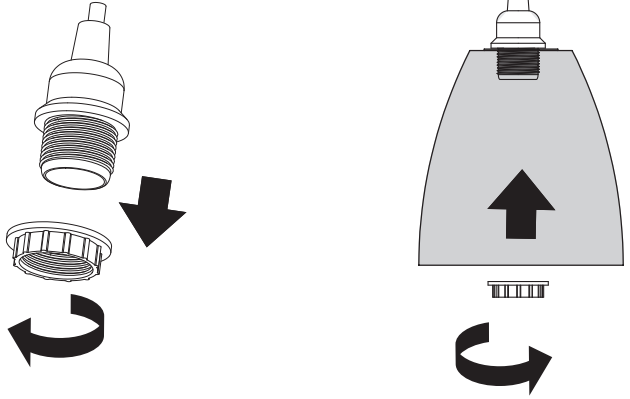
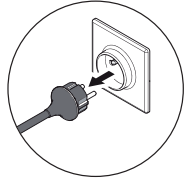

2

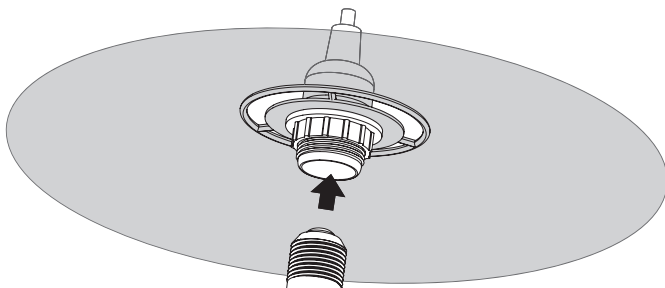

E27
15W Max.

