









## Ficha técnica

### Rueda B-PGI 1-0548

Codigo				Tipo cojinete Eje					
1-0548	50	22	18	—	70x55	54x38	6	72	46



#### Características

Fabricada con chapa de acero embutida hasta 2 mm de espesor.  
Soporte con rodamiento a bolas.  
Acabado cincado.  
Ruedas de goma de 50 y 60 de diámetro con protectores incluidos de serie.  
Fabricadas según normas europeas EN 12528.

#### Datos técnicos

**Diámetro:** 50 mm  
**Carga:** 22 kg  
**Tipo de cojinete:** Cojinete Liso  
**Ancho de Banda de rodadura:** 18 mm  
**Medidas de placa superior:** 70x55 mm  
**Distancia entre agujeros:** 54x38 mm  
**Diámetro agujero sujeción platina:** 6 mm  
**Altura total:** 72 mm  
**Radio de giro:** 46 mm

#### Archivos CAD

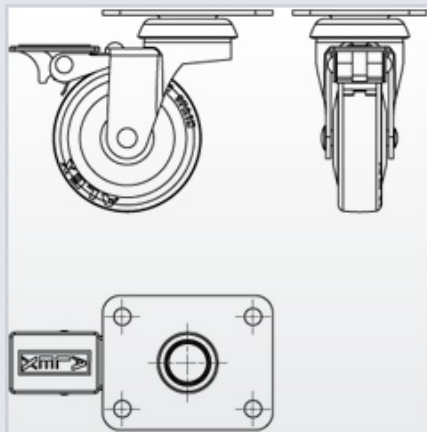
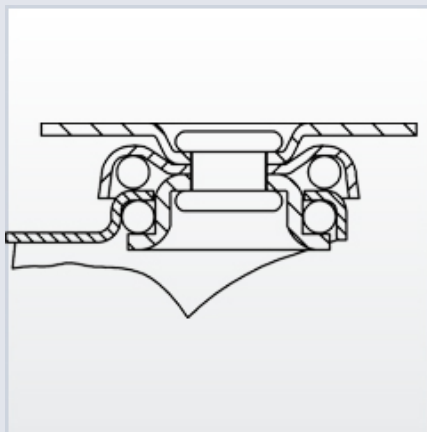

#### Rueda

**PGI (Goma)**  
Núcleo de poliamix y banda de goma gris  
**Rango de temperatura:** -20° ÷ +60°

#### Productos relacionados

