

Pulsador 10A 250V~. Monobloc. De empotrar.

Pulsador 10A 250V~. Embornamiento por tornillo. De empotrar. Color blanco.

Dimensiones 83 x 81 mm. Monobloc.

Aplicaciones habituales: Entorno domestico/terciario interior (Interior de vivienda, oficinas, comercios, etc..)



Características

Tipo de mecanismo	Pulsador campana
Tipo de instalación	Empotrar
Corriente nominal	10AX
Tensión nominal	250V~ (50/60 Hz)
Tipo de conexión	Conexión por tornillo
Tipo de accionamiento	Tecla basculante
Dimensiones	83 x 81
Con garras de fijación	Sí
Monobloc (con marco incluido)	Sí
Color marco	Blanco

Datos técnicos

Grado de protección (IP)	IP40
Resistencia al fuego (GWEPT)	850 °C
Resistencia al calor (Presión bola)	70/125 °C
Libre de halógenos	Sí

Normativa

Marcado CE	Sí
------------	----

Marcado UK	Sí
Marcado CMim	Sí
Conforme a Normativa UNE/EN	UNE-EN 60669-1:2018
Conforme a REBT	Sí
Certificado TÜV Rheinland	Sí
Conforme a Directiva Europea 2014/35/UE. Directiva de baja tensión	Sí

Sostenibilidad

Conforme Directiva Europea 2011/65/UE (RoHS)	Sí
Conforme Directiva europea 2012/19/UE (RAEE2)	Sí





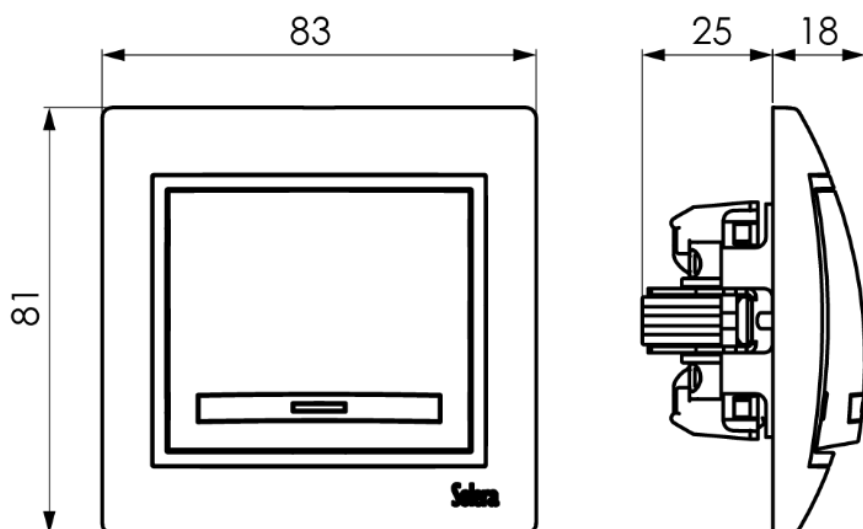

Logística y embalaje

Código EAN unitario	8423220076549
Código EAN envase	8423220076907
Código EAN embalaje	18423220076904
Uds. Envase	10
Uds. Embalaje	120
Uds. Pallet	4320
Medidas Envase cm	26x10x14
Medidas Embalaje cm	44x40x27,5
Peso unitario (g)	89
Peso Envase (Kg)	1,04
Peso Embalaje (Kg)	13,20
Código arancelario	85366990

Croquis



Documentación y descargas

- | | | | |
|--|---|---|---|
|  | Instrucciones de montaje (0.58MB) |  | Documentación comercial (20.04MB) |
|  | Tabla esquemas mecanismos (0.91MB) |  | Certificado (0.09MB) |
|  | Mecanismos de empotrar, serie Europa (Solera) |  | Montaje de los mecanismos de empotrar de la serie Europa (Solera) |