

EAN : 3276007823066

Adeo key : 91468751

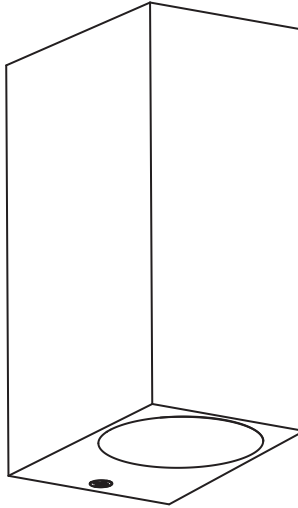

2/2



2024-05-V01

FR - Manuel d'Instructions

ES - Manual de Instrucciones

PT - Manual de Instruções

IT - Manuale di Istruzioni

EL - Εγχειρίδιο Οδηγιών

PL - Instrukcja Obsługi

UA - Інструкція з Експлуатації

RO - Manual de Instrucțiuni

BR - Manual de Instrução

NL - Handleiding

DE - Anleitung Handbuch

EN - Instructions Manual

*Année de garantie / años de garantía / Ano de garantia / Anno di garanzia / Έτος εγγύησης / Rok gwarancji / Гарантіяроків / Anul de garanție / Anos de garantía / Garantiejaar / Jahr der Garantie / Year of guarantee

** réparable / reparabile / reparável / riparabile / διορθώσιμος / naprawiany / ремонтний / reparabil / reparaturfähig / reparável / herstelbaar / reparierbar / repairable



FR : assemblage / **ES** : ensamblaje / **PT** : montagem / **IT** : assemblaggio /
EL : συναρμολόγηση / **PL** : montaż / **UA** : збірка / **RO** : asamblare /
BR : montagem / **NL** : samenstelling / **DE** : Montage / **EN** : assembly

FR : CARACTÉRISTIQUES TECHNIQUES / **ES** : CARACTERÍSTICAS TÉCNICAS /
PT : CARACTERÍSTICAS TÉCNICAS / **IT** : CARATTERISTICHE TECNICHE / **EL** : ΤΕΧΝΙΚΑ
ΧΑΡΑΚΤΗΡΙΣΤΙΚΑ / **PL** : CECHY TECHNICZNE / **UA** : ΤΕΧΝΙЧНІ ХАРАКТЕРИСТИКИ /
RO : CARACTERISTICI TEHNICE / **BR** : CARACTERÍSTICAS TÉCNICAS / **NL** : TECHNISCHE KENMERKEN
/ **DE** : TECHNISCHE MERKMALE / **EN** : TECHNICAL SPECIFICATIONS



A1.

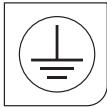

A2.



A6.

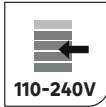

A7.



A9.



A10.

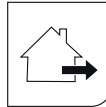

A13.

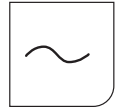

A16.



A19.

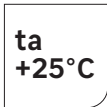

A26.



A32.



E1.

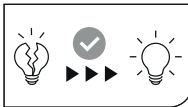

T7.

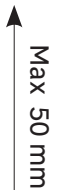
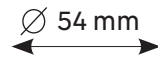
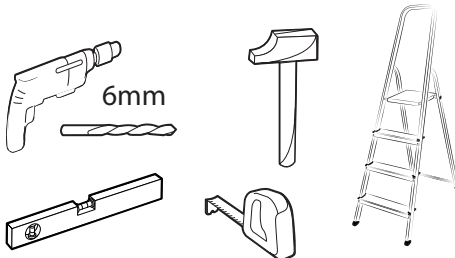
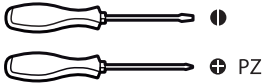
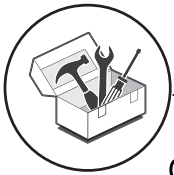
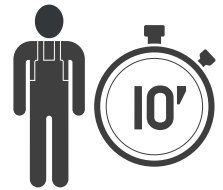
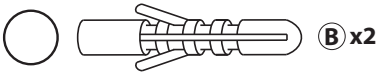
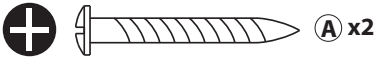
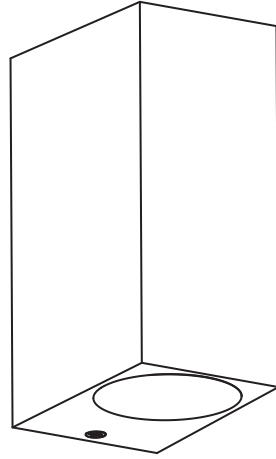

GU10 LED

2x7W Max

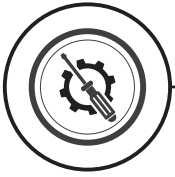

1

1

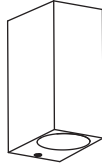
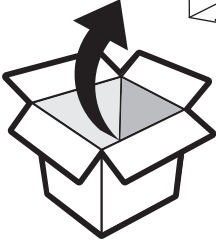

2

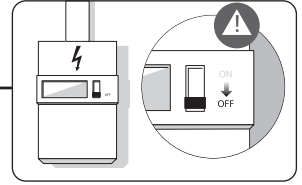
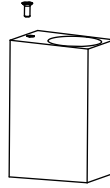

3

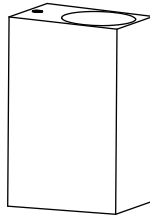
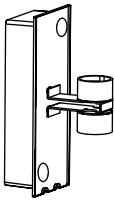

4

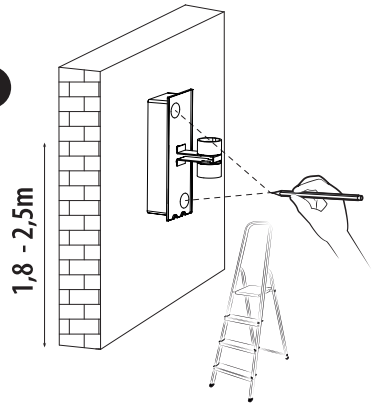

2

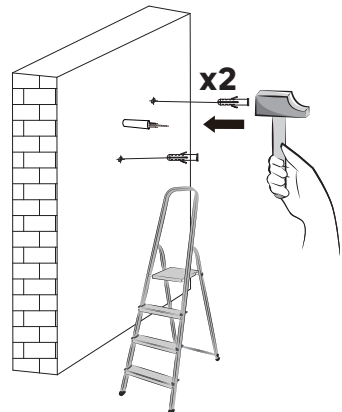
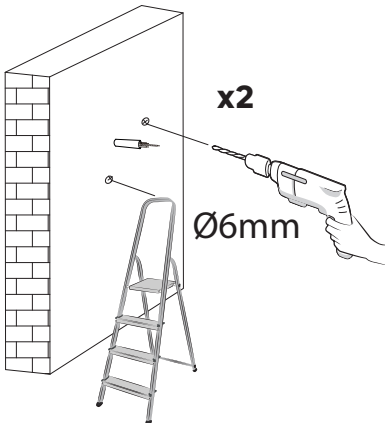

3

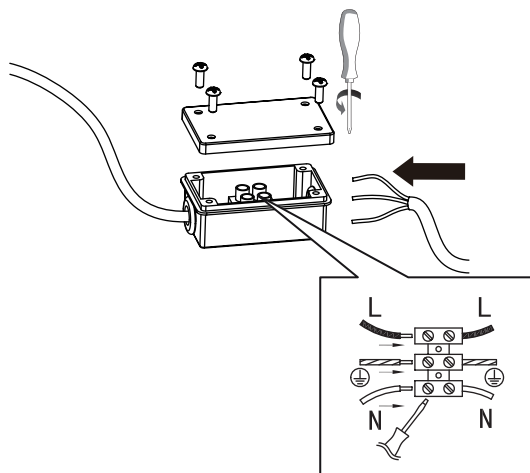

L=Marron/Marrón/Castanho/Marrone/Καφέ
Brazowy/Коричневый/Қоңыр
Коричневий/Maró/Castanho/Brown
N=Bleu/Azul/Azul/Blu/Μπλε/Niebieski
Синий/Көк/Синий/Albastru/Azul/Blue
⊕=Vert/Verde/Verde/Verde/Πράσινο
Zielony/Зеленый/Жасыл/Зеленый
Verde/Verde/Green

4

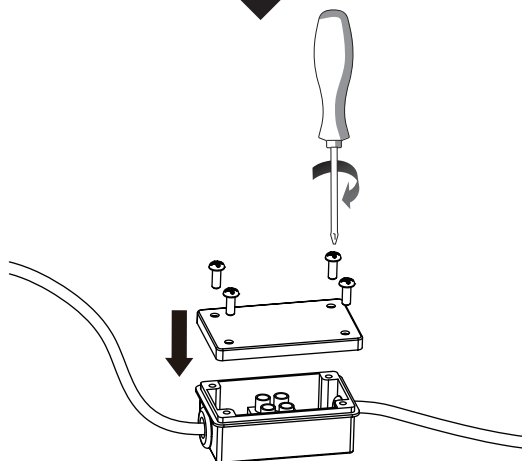

5

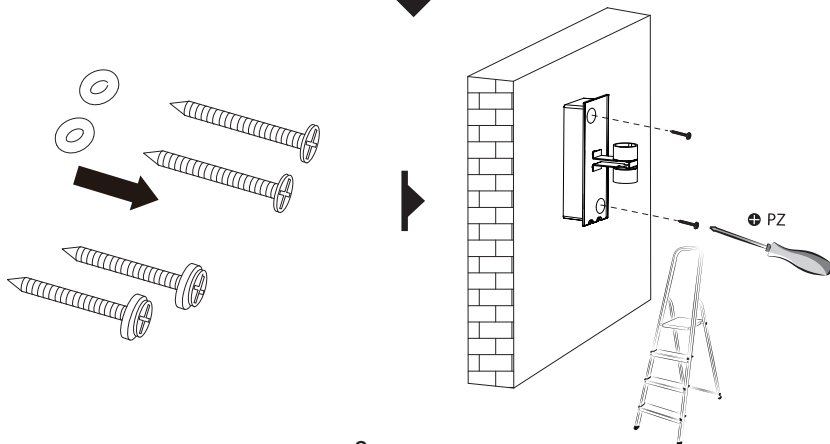

6

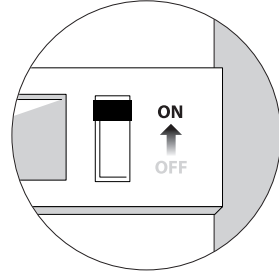
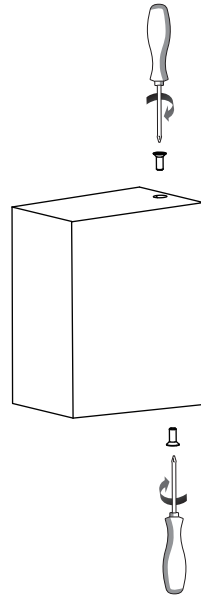
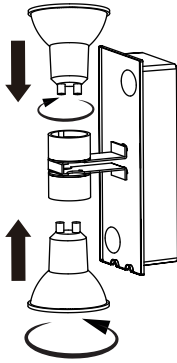



Made in China
Країна походження: Китай

EU - ADEO Services - 135 Rue Sadi Carnot - CS00001 - 59790 RONCHIN - FRANCE
www.product-regulatory.adeoservices.com

UA Виробник: ТОВ "Адео Сервісез С.А.", вул. Саді Карно, СС 00001, 59790 Роншен, Франція.
Імпортер: ТОВ "Леруа Мерлен Україна", 04201 Україна, м.Київ, вул. Полярна 17А, +380 44 498 46 00. Імпортер приймає претензії від споживачів щодо товару, а також проводить його ремонт, технічне і гарантійне обслуговування

BR LEROY MERLIN COMPANHIA BRASILEIRA DE BRICOLAGEM
CNPJ: 01.438.784/0001-05
Rua Pascoal Pais, nº. 525, 6º andar cj 61 a 64, Vila Cordeiro, São Paulo -SP. CEP: 04581-060
CALM (Central de Atendimento Leroy Merlin) Capitais
4020-5376 Demais Regiões 0800-0205376

ZA Imported by Adeo South Africa (PTY) LTD T/A Leroy Merlin,
Hosted in Leroy Merlin Fourways Store 35 Roos Street, Witkoppen
Ext 97, Sandton, 2191 Johannesburg, Gauteng, South Africa.
Tel: +27 10 493 8000 Email: contact@leroymerlin.co.za.



Points de collecte sur www.quefairedemesdechets.fr
Privilégiez la réparation ou le don de votre appareil !