

EAN : 3276007960532  
 3276007960693  
 3276007960716  
 3276007960587  
 3276007960570  
 3276007960594  
 3276007960723  
 3276007960556  
 3276007960600

Adeo Key : 95420512  
 95420545  
 95420548  
 95420523  
 95420520  
 95420524  
 95420550  
 95420515  
 95420526

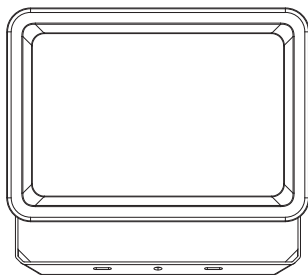

2/2



**FR** - Manuel d'Instructions

**ES** - Manual de Instrucciones

**PT** - Manual de Instruções

**IT** - Manuale di Istruzioni

**EL** - Εγχειρίδιο Οδηγιών

**PL** - Instrukcja Obsługi

**UA** - Інструкція з Експлуатації

**RO** - Manual de Instrucțiuni

**BR** - Manual de Instrução

**NL** - Handleiding

**DE** - Anleitung Handbuch

**EN** - Instructions Manual

\*Année de garantie / años de garantía / Ano de garantia / Anno di garanzia / Έτος εγγύησης / Rok gwarancji / Гарантія роки / Anul de garanție / Anos de garantía / Garantiejaar / Jahr der Garantie / Year of guarantee

\*\* réparable / reparabile / reparável / riparabile / διορθώσιμος / naprawiany / ремонтний / reparabil / reparaturfähig / reparável / herstelbaar / reparierbar / repairable





**FR:** assemblage / **ES:** ensamblaje / **PT:** montagem / **IT:** assemblaggio /  
**EL:** συναρμολόγηση / **PL:** montaż / **UA:** збірка / **RO:** asamblare /  
**BR:** montagem / **NE:** samenstelling / **DE:** Montage / **EN:** assembly

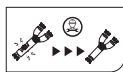

**FR:** Utilisation / **ES:** Uso / **PT:** Utilização / **IT:** Utilizzo  
**EL:** Χρήση / **PL:** Użycie / **UA:** Використання / **RO:** Utilizare / **BR:** Utili-  
 zação / **NE:** Gebruik / **DE:** Verwendung / **EN:** Use



FR -Ce produit contient 1 source lumineuse de classe d'efficacité énergétique D. (EU) 2019/2015  
 ES -Este producto contiene 1 fuente de luz de clase de eficiencia D. (EU) 2019/2015  
 PT- Este produto contém 1 fonte de luz de eficiência energética de classe D. (EU) 2019/2015  
 IT -Questo prodotto contiene 1 sorgente luminosa di classe di efficienza energetica D. (EU) 2019/2015  
 EL -Αυτό το προϊόν περιέχει πηγή φωτός κατηγορίας ενεργειακής απόδοσης D. (EU) 2019/2015  
 PL -Niniejszy produkt zawiera źródło światła klasy efektywności energetycznej D. (EU) 2019/2015  
 UA -Цей продукт містить джерело світла класу енергоєфективності D. (EU) 2019/2015  
 RO -Acest produs conține o sursă de lumină cu clasa de eficiență energetică D. (EU) 2019/2015  
 BR -Este produto contém 1 fonte de luz de classe de eficiência energética D. (EU) 2019/2015  
 NL -Dit product omvat een lamp van de energie-efficiëntieklasse D (EU) 2019/2015  
 DE -Dieses Produkt enthält 1 Lichtquelle der Energieeffizienzklasse D. (EU) 2019/2015  
 EN -This product includes 1 light source of the energy efficiency class D. (EU) 2019/2015

EAN	 Max W	LED Reference	 PF > X.X	Weight	Dimension(LXWXH)	Projected area	Supply current
3276007960693	10w	TL8810D CCT	PF>0.7	0.27KG	13.2X6.7X13.1CM	0.005m <sup>2</sup>	0.046A
3276007960716	20w	TL8820D CCT	PF>0.7	0.36KG	14.8X6.8X14.5CM	0.006m <sup>2</sup>	0.090A
3276007960587	30w	TL8830D CCT	PF>0.9	0.38KG	15.4X6.8X14.7CM	0.007m <sup>2</sup>	0.136A
3276007960570	50w	TL8850D CCT	PF>0.9	0.59KG	18X7.1X16.8CM	0.013m <sup>2</sup>	0.217A
3276007960594	100w	TL88100D CCT	PF>0.9	1.14KG	24.5X7.5X21.6CM	0.027m <sup>2</sup>	0.448A
3276007960723	150w	TL88150D CCT	PF>0.9	1.76KG	30.4X7.2X28.1CM	0.042m <sup>2</sup>	0.652A
3276007960556	20w	TL8820D CCT	PF>0.7	0.36KG	14.8X6.8X14.5CM	0.006m <sup>2</sup>	0.090A
3276007960600	30w	TL8830D CCT	PF>0.9	0.38KG	15.4X6.8X14.7CM	0.007m <sup>2</sup>	0.136A
3276007960532	50w	TL8850D CCT	PF>0.9	0.59KG	18X7.1X16.8CM	0.013m <sup>2</sup>	0.217A

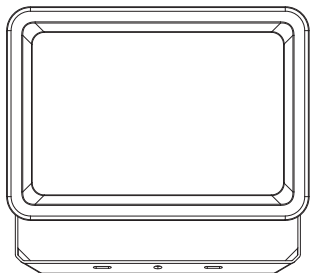

10W/20W/30W/50W Ø6mm  
100W/150W Ø8mm

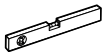

⊕ PZ

N → 5mm

A



x2

B



x2

C



x2

10W/20W/30W/50W 100W/150W

A: st4x30mm

A: st5x40mm

B: Ø6x30mm

B: Ø8x40mm

C: Ø4mm

C: Ø5mm

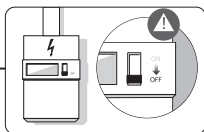

# 1

## 1

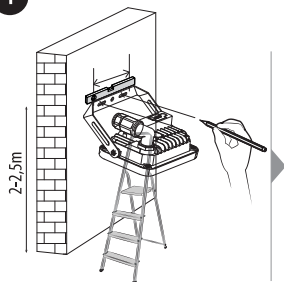

## 2

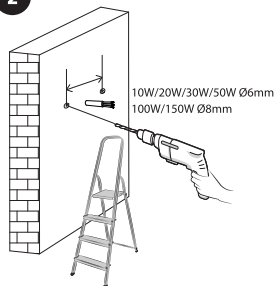

## 3

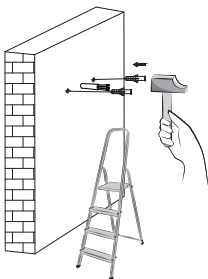

## 4

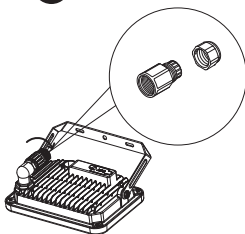

# 2

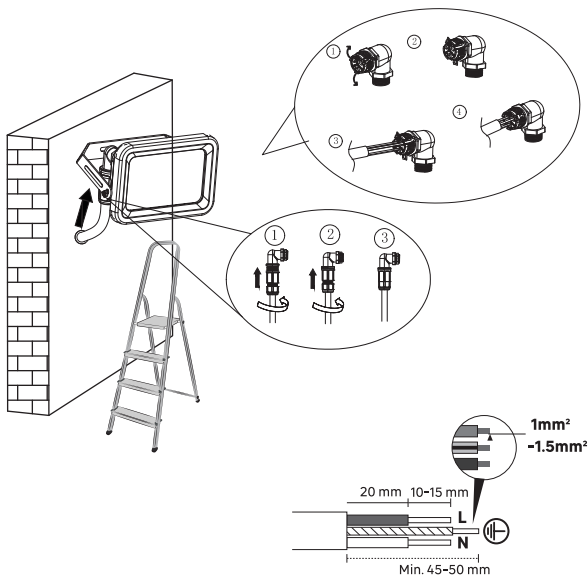

**N** =Bleu/Azul/Azul/Blu/Μπλε/Niebieski/Синій/Albastru/ Blauw/Blau/**Blue**

 =Vert et jaune/Verde y amarillo/Verde e giallo/Πράσινο και κίτρινο /Zielony i żółty /Зелений і жовтий/Verde-galben/Verde e amarelo/Groen en geel/Grün und gelb/**Green and yellow**

**L** =Marron/Marrón/Castanho/Marrone/Καφέ/Brązowy/Коричневий/Maro/Marrom/bruin/Braun/**Brown**

# 3

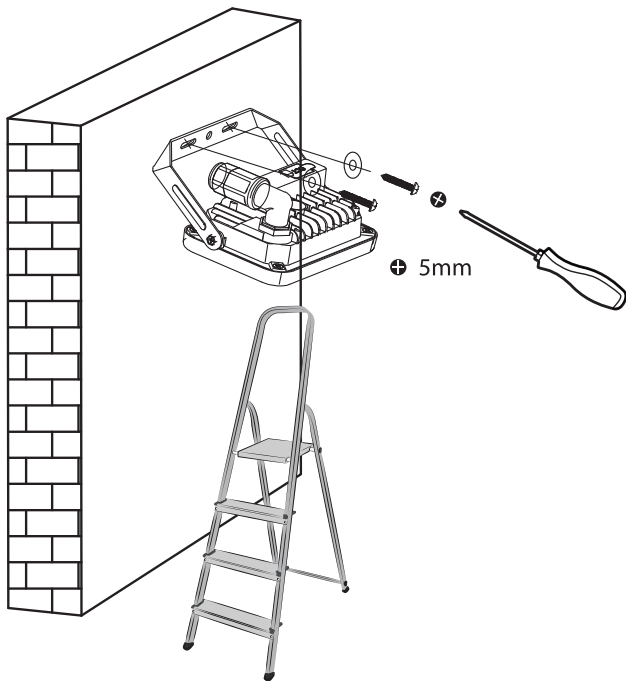

**FR** - Utiliser des vis et des chevilles adaptées à votre support. / **ES** - Utilice tacos y tornillos adecuados al soporte. / **PT** - Utilize buchas e parafusos adequado ao seu suporte. / **IT** - Utilizzare viti e tasselli adatti per il retro. / **EL** - Χρησιμοποιήστε βίδες και βύσματα που ταιριάζουν στην επιφάνεια στήριξης. / **PL** - Należy użyć śrub i kotków odpowiednich dla podłoża. / **UA** - Використовуйте гвинти та шканти, призначені для задньої поверхні. / **RO** - Utilizați șuruburi și dibluri adecvate pentru suportul dvs. / **BR** - Use parafusos e buchas adequados para seu suporte. / **NL** - Gebruik schroeven en pluggen die geschikt zijn voor uw ondergrond. / **DE** - Verwenden Sie für Ihre Unterlage geeignete Schrauben und Dübel. / **EN** - Use screws and dowels suited to your backing.

# 4

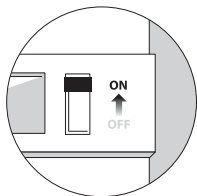
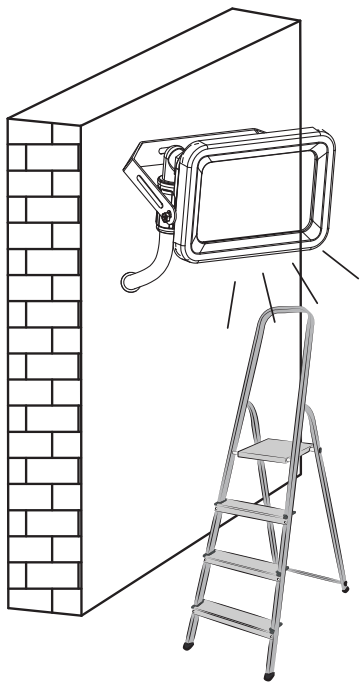



1

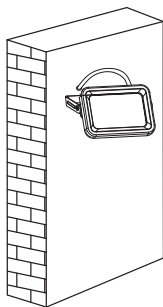
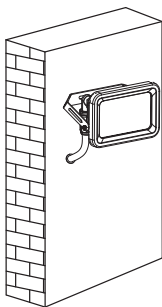
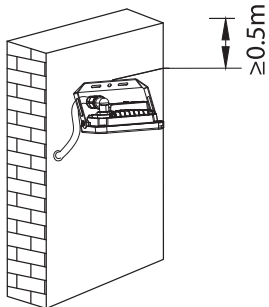
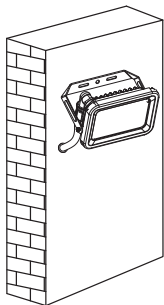

# 2

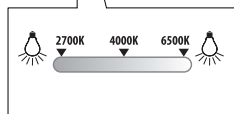
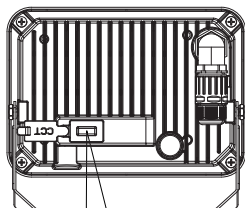
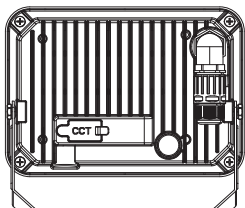

## \*warm light 2700K

FR: \*lumière chaude. ES: \*luz cálida. PT: \*luz quente. IT: \*luce calda. EL: \*ζεστό φως. PL: \*ciepłe światło. UA: \*тепле світло. RO: \*lumină caldă. BR: \*luz quente. NL: \*warm licht. DE: \*warmes Licht.

## \*Neutral Light 4000K

FR: \* lumière Neutre. ES: \*luz Neutra. PT: \*luz Neutra. IT: \*luce Neutra. PL: \*światło Neutralne. EL: \*ουδέτερο Φως. UA: \*Нейтральне Світло. RO: \*Lumină Neutră. BR: \*Luz Neutra. DE: \*Neutrales Licht. NL: \*Neutraal Licht.

## \*cold light 6500K

FR: \*lumière froide. ES: \*luz fría. PT: \*luz fria. IT: \*luce fredda. EL: \*κρύο φως. PL: \*zimne światło. UA: \*холодне світло. RO: \*lumină rece. BR: \*luz fria. NL: \*koud licht. DE: \*kaltes Licht.





Points de collecte sur [www.quefairedemesdechets.fr](http://www.quefairedemesdechets.fr)  
Privilégiez la réparation ou le don de votre appareil !

FR: Traduction de la version originale du mode d'emploi / ES: Traducción de las Instrucciones originales / PT: Tradução das Instruções Originais / IT: Traduzione delle istruzioni originali / EL: Μετάφραση των πρωτότυπων οδηγιών / PL: Tłumaczenie instrukcji oryginalnej / UA: Переклад оригінальної інструкції / RO: Traducerea instrucțiunilor originale / BR: Tradução das Instruções Originais / DE: Übersetzung der Originalversion der Gebrauchsanweisung / Original Instructions.

Made in China  
Країна походження: Китай

**EU - ADEO Services - 135 Rue Sadi Carnot - CS00001 - 59790 RONCHIN - FRANCE**

[www.product-regulatory.adeoservices.com](http://www.product-regulatory.adeoservices.com)

UA-Виробник: ТОВ «Адео Сервісез С.А.», вул. Саді Карно, CS 00001, 59790 Роншен, Франція. Імпортер, суб'єкт господарювання, що відповідає за виконання гарантійних зобов'язань: ТОВ «Леруа Мерлен Україна», 04201 Україна, м. Київ, вул. Полярна 17А, +380 44 498 46 00.

BR-IMPORTADO E DISTRIBUÍDO POR: LEROY MERLIN COMPANHIA BRASILEIRA DE BRICOLAGEM CNPJ: 01.438.784/0001-05 Rua Pascoal Pais, nº. 525, 6º andar, cj 61 a 64 - Vila Cordeiro, São Paulo - SP CEP: 04581-060 CALM (Central de Atendimento Leroy Merlin) Capitais 4020-5376 Demais Regiões 0800-0205376

ZA-Imported by Adeo South Africa (PTY) LTD T/A Leroy Merlin, Hosted in Leroy Merlin Fourways Store 35 Roos Street, Witkoppen Ext 97, Sandton, 2191 Johannesburg, Gauteng, South Africa. Tel: +27 10 493 8000 Email: [contact@leroymerlin.co.za](mailto:contact@leroymerlin.co.za).

