

EAN : 3276007822823  
Adeo key : 91468683

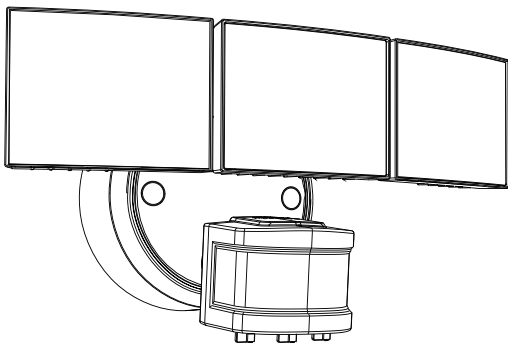

2/2



2024-09-V01

FR - Manuel d'Instructions

ES - Manual de Instrucciones

PT - Manual de Instruções

IT - Manuale di Istruzioni

EL - Εγχειρίδιο Οδηγιών

PL - Instrukcja Obsługi

UA - Інструкція з Експлуатації

RO - Manual de Instrucțiuni

BR - Manual de Instrução

NL - Handleiding

DE - Anleitung Handbuch

EN - Instructions Manual



**FR:** assemblage / **ES:** ensamblaje / **PT:** montagem / **IT:** assemblaggio /  
**EL:** συναρμολόγηση / **PL:** montaż / **UA:** збірка / **RO:** asamblare /  
**BR:** montagem / **NL:** samenstelling / **DE:** Montage / **EN:** assembly



**FR:** Utilisation / **ES:** Uso / **PT:** Utilização / **IT:** Utilizzo  
**EL:** Χρήση / **PL:** Użycie / **UA:** Використання / **RO:** Utilizare /  
**BR:** Utilização / **NL:** Gebruik / **DE:** Verwendung / **EN:** Use

**FR:** CARACTÉRISTIQUES TECHNIQUES / **ES:** CARACTERÍSTICAS TÉCNICAS /  
**PT:** CARACTERÍSTICAS TÉCNICAS / **IT:** CARATTERISTICHE TECNICHE / **EL:** ΤΕΧΝΙΚΑ  
ΧΑΡΑΚΤΗΡΙΣΤΙΚΑ / **PL:** CECHY TECHNICZNE / **UA:** ΤΕΧΝΙΚΗ ΧΑΡΑΚΤΗΡΙΣΤΙΚΑ /  
**RO:** CARACTERISTICI TEHNICE / **BR:** CARACTERÍSTICAS TÉCNICAS / **NL:** TECHNISCHE KENMERKEN  
/ **DE:** TECHNISCHE MERKMALE / **EN:** TECHNICAL SPECIFICATIONS



**A1.**



**A2.**



**A6.**



**A7.**



**A9.**



**A10.**



**A11.**



**A13.**



**A16.**



**A21.**



PF>0.9

**A25.**



**A26.**



**E1**



**T6.**



**T10.**



272x148x148mm



0.760kg



0.01955m<sup>2</sup>

## LED

TL-IS18a\_LED

**FR** Ce produit contient une source lumineuse de classe d'efficacité énergétique C. (EU) 2019/2015

**ES** Este producto contiene una bombilla de clase de eficiencia C. (EU) 2019/2015

**PT** Este produto contém uma fonte de luz de eficiência energética de classe C. (EU) 2019/2015

**IT** Questo prodotto contiene una sorgente luminosa di classe di efficienza energetica C. (EU) 2019/2015

**EL** Αυτό το προϊόν περιέχει πηγή φωτός κατηγορίας ενεργειακής απόδοσης C. (EU) 2019/2015

**PL** Niniejszy produkt zawiera źródło światła klasy efektywności energetycznej C. (EU) 2019/2015

**UA** Данное изделие содержит источник света класса энергоэффективности C. (EU) 2019/2015

**RO** Acest produs conține o sursă de lumină din clasa de eficiență energetică C. (EU) 2019/2015

**BR** Este produto contém uma fonte de luz de classe X de eficiência energética C. (EU) 2019/2015

**NL** Dit product bevat een lamp van energie-efficiëntieklasse C. (EU) 2019/2015

**DE** Dieses Produkt enthält ein Licht der Energieeffizienzklasse C. (EU) 2019/2015

**EN** This product includes a light of the energy efficiency class C. (EU) 2019/2015

(EU) 2019/2015

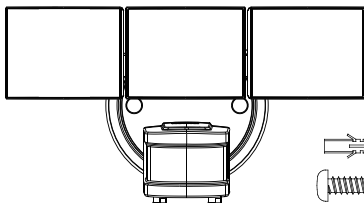

x3



x3



x2



x3



x2

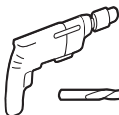
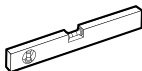

Ø 06



⊕ PZ

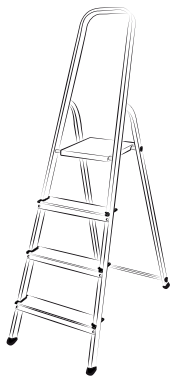

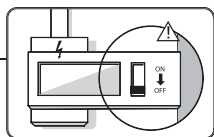

1

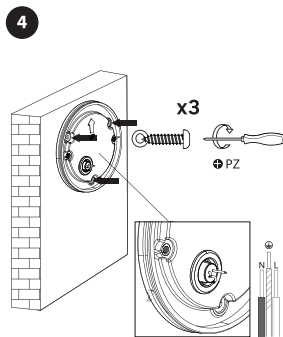
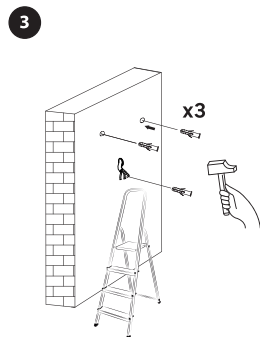
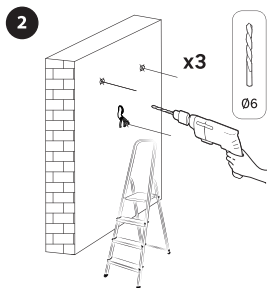
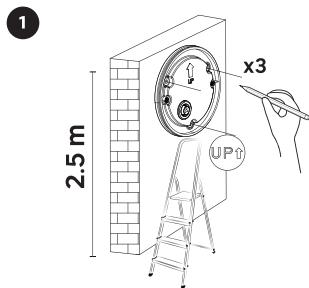

# 2

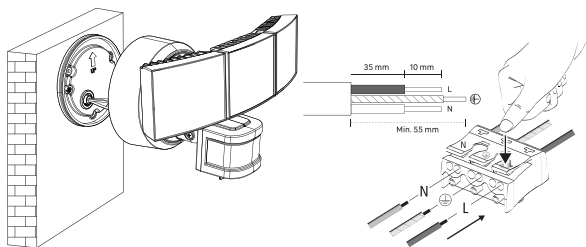

# 3

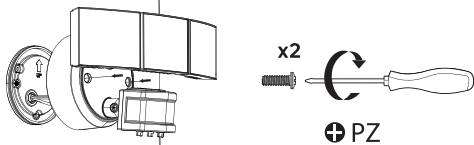

# 4

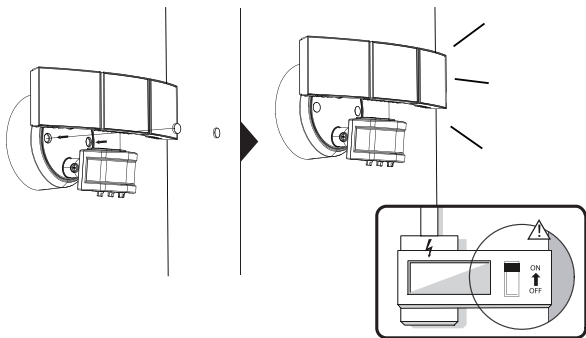



# 1

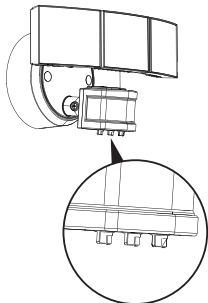

	 2.000 LUX	 1.000 LUX	 750 LUX	 10 LUX
 Test LUX D2D	 ▶ OFF	 ▶ ON	 ▶ ON	 ▶ ON
 Test LUX D2D	 ▶ OFF	 ▶ OFF	 ▶ ON	 ▶ ON
 Test LUX D2D	 ▶ OFF	 ▶ OFF	 OFF	 ▶ ON

# 2

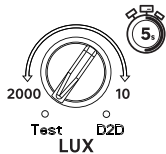

Test Mode\*

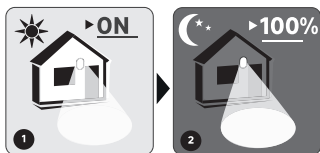

\*FR: Mode test ES: Modo de prueba PT: Modo de teste IT: Modalità di prova EL: Λειτουργία δοκιμής PL: Tryb testowy UA: Режим тесту RO: Mod de test BR: Modo de teste NL: Testmodus DE: Testmodus

# 3

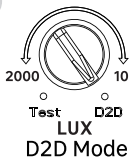

PIR OFF

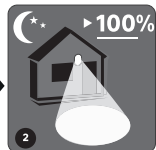
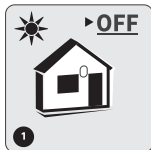

# 4

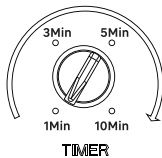
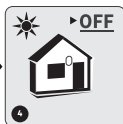

# 5

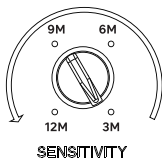

3M

6M

9M

12M



Made in China  
Країна походження: Китай

Batch no: XXXXXXXXXX

**EU** - ADEO Services - 135 Rue Sadi Carnot - CS00001 - 59790 RONCHIN - FRANCE  
[www.product-regulatory.adeoservices.com](http://www.product-regulatory.adeoservices.com)

**UA** Виробник: ТОВ "Адео Сервісез С.А.", вул. Саді Карно, CS 00001, 59790 Роншен, Франція.  
Імпортер: ТОВ "Леруа Мерлен Україна", 04201 Україна, м.Київ, вул. Полярна 17А, +380 44 498 46 00. Імпортер приймає претензії від споживачів щодо товару, а також проводить його ремонт, технічне і гарантійне обслуговування

**BR** LEROY MERLIN COMPANHIA BRASILEIRA DE BRICOLAGEM CNPJ: 01.438.784/0001-05  
Rua Pascoal Pais, nº. 525, 6º andar cj 61 a 64, Vila Cordeiro, São Paulo -SP. CEP: 04581-060  
CALM (Central de Atendimento Leroy Merlin) Capitais 4020-5376 Demais Regiões 0800-0205376

**ZA** Imported by Adeo South Africa (PTY) LTD T/A Leroy Merlin,  
Hosted in Leroy Merlin Fourways Store 35 Roos Street, Witkoppen Ext 97, Sandton, 2191 Johannesburg, Gauteng, South Africa.  
Tel: +27 10 493 8000 Email: [contact@leroymerlin.co.za](mailto:contact@leroymerlin.co.za).



Points de collecte sur [www.quefairedemesdechets.fr](http://www.quefairedemesdechets.fr)  
Privilégiez la réparation ou le don de votre appareil !