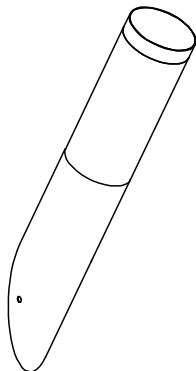

EAN : 3276007632514
Adeo Key : 87505585

**2/2**

2025-05-V01

FR - Manuel d'Instructions**ES -** Manual de Instrucciones**PT -** Manual de Instruções**IT -** Manuale di Istruzioni**EL -** Εγχειρίδιο Οδηγών**PL -** Instrukcja Obsługi**UA -** Інструкція з Експлуатації**RO -** Manual de Instrucțiuni**BR -** Manual de Instrução**NL -** Handleiding**DE -** Anleitung Handbuch**EN -** Instructions Manual

*Année de garantie / años de garantía / Ano de garantia / Anno di garanzia / Έτος εγγύησης / Rok gwarancji /
Гарантіяроків / Anul de garanție / Anos de garantia / Garantiejaar / Jahr der Garantie / Year of guarantee

** réparable / reparabile / reparável / riparabile / διορθώσιμος / naprawiany / ремонтний / reparabil / reparaturfähig /
reparável / herstelbaar / reparierbar / repairable



FR : assemblage / **ES** : ensamblaje / **PT** : montagem / **IT** : assemblaggio /
EL : συναρμολόγηση / **PL** : montaż / **UA** : збірка / **RO** : asamblare /
BR : montagem / **NL** : samenstelling / **DE** : Montage / **EN** : assembly



1/2

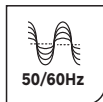
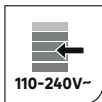

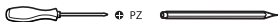
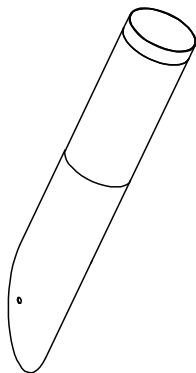

N°1-5mm



Ø 6mm



E27 MAX 25W

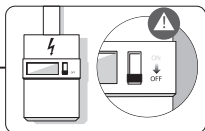

1

1

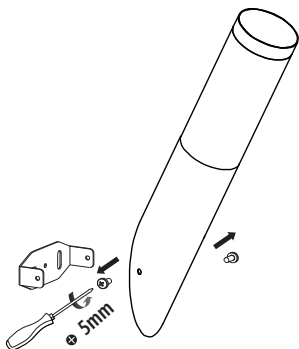

2

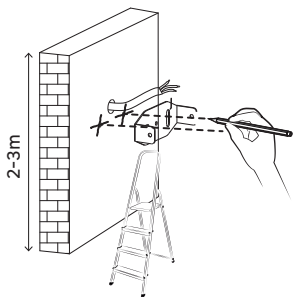

3

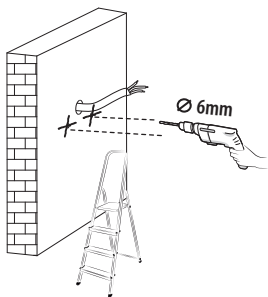

2

4

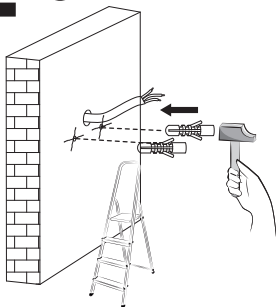

5

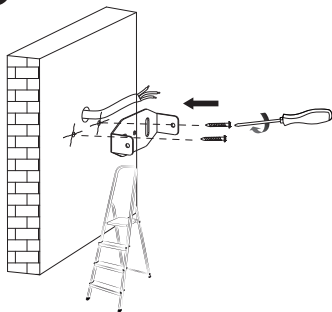

FR - Utiliser des vis et des chevilles adaptées à votre support. / **ES** - Utilice tacos y tornillos adecuados al soporte. / **PT** - Utilize buchas e parafusos adequado ao seu suporte. / **IT** - Utilizzare viti e tasselli adatti per il retro. / **GR** - Χρησιμοποιήστε βίδες και βύσματα που ταιριάζουν στην επιφάνεια στήριξης. / **PL** - Należy użyć śrub i kołków odpowiednich dla podłoża. / **UA** - Використовуйте гвинти та шканти, призначені для задньої поверхні. / **RO** - Utilizați șuruburi și dibluri adecvate pentru suportul dvs. / **BR** - Use parafusos e buchas adequados para seu suporte. / **NL** - Gebruik schroeven en pluggen die geschikt zijn voor uw ondergrond. / **DE** - Verwenden Sie für Ihre Unterlage geeignete Schrauben und Dübel. / **EN** - Use screws and dowels suited to your backing.

6

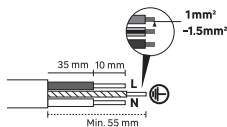
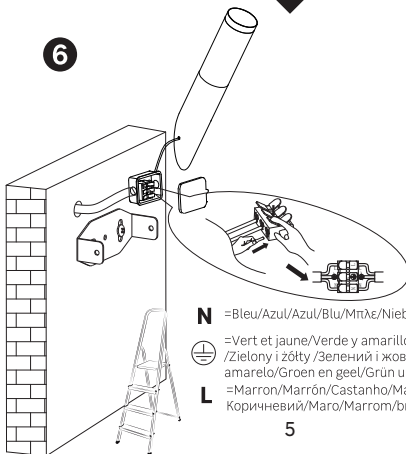

- N** = Bleu/Azul/Azul/Blu/Μπλε/Niebieski/Синий/Albastru/ Blauw/Blau/**Blue**
⊕ = Vert et jaune/Verde y amarillo/Verde e giallo/Πράσινο και κίτρινο /Zielony i żółty /Зеленый и жовтий/Verde-galben/Verde e amarelo/Groen en geel/Grün und gelb/**Green and yellow**
L = Marron/Marrón/Castanho/Marrone/Καφέ/Brazowy/Коричневий/Maro/Marrom/bruin/Braun/**Brown**

3

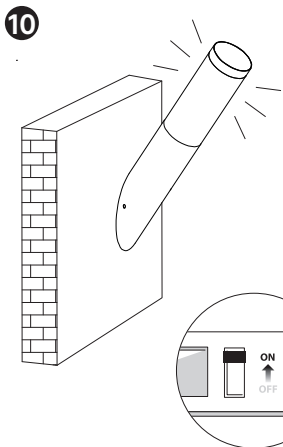
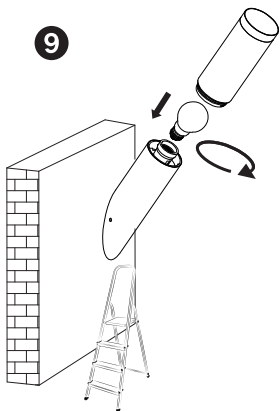
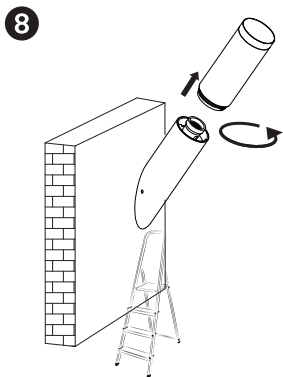
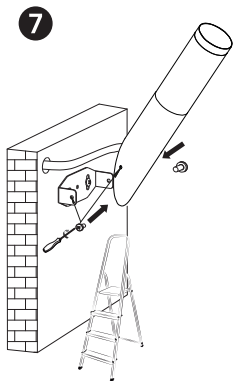



Points de collecte sur www.quefairedemesdechets.fr
Privilégiez la réparation ou le don de votre appareil !

FR: Traduction de la version originale du mode d'emploi / ES: Traducción de las Instrucciones originales / PT: Tradução das Instruções Originais / IT: Traduzione delle istruzioni originali / EL: Μετάφραση των πρωτότυπων οδηγιών / PL: Tłumaczenie instrukcji oryginalnej / UA: Переклад оригінальної інструкції / RO: Traducerea instrucțiunilor originale / BR: Tradução das Instruções Originais / DE: Übersetzung der Originalversion der Gebrauchsanweisung / Original Instructions.

Made in China
Країна походження: Китай

EU - ADEO Services - 135 Rue Sadi Carnot - CS00001 - 59790 RONCHIN - FRANCE

www.product-regulatory.adeoservices.com

UA-Виробник: ТОВ «Адео Сервісез С.А.», вул. Саді Карно, CS 00001, 59790 Роншен, Франція. Імпортер, суб'єкт господарювання, що відповідає за виконання гарантійних зобов'язань: ТОВ «Леруа Мерлен Україна», 04201 Україна, м. Київ, вул. Полярна 17А, +380 44 498 46 00.

BR-IMPORTADO E DISTRIBUÍDO POR: LEROY MERLIN COMPANHIA BRASILEIRA DE BRICOLAGEM CNPJ: 01.438.784/0001-05 Rua Pascoal Pais, nº. 525, 6º andar, cj 61 a 64 - Vila Cordeiro, São Paulo - SP CEP: 04581-060 CALM (Central de Atendimento Leroy Merlin) Capitais 4020-5376 Demais Regiões 0800-0205376

ZA-Imported by Adeo South Africa (PTY) LTD T/A Leroy Merlin, Hosted in Leroy Merlin Fourways Store 35 Roos Street, Witkoppen Ext 97, Sandton, 2191 Johannesburg, Gauteng, South Africa. Tel: +27 10 493 8000 Email: contact@leroymerlin.co.za.

