

EAN: Adeo Key:
3276007632354 87505581
3276007632330 87505582

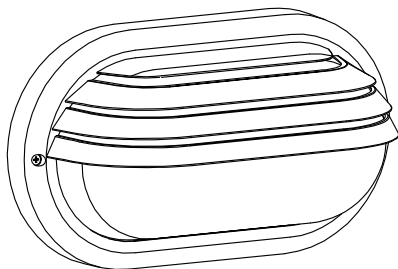

2/2



FR - Manuel d'Instructions

ES - Manual de Instrucciones

PT - Manual de Instruções

IT - Manuale di Istruzioni

EL - Εγχειρίδιο Οδηγιών

PL - Instrukcja Obsługi

UA - Інструкція з Експлуатації

RO - Manual de Instrucțiuni

BR - Manual de Instrução

NL - Handleiding

DE - Anleitung Handbuch

EN - Instructions Manual

*Année de garantie / años de garantía / Ano de garantia / Anno di garanzia / Έτος εγγύησης / Rok gwarancji /
Гарантія років / Anul de garanție / Anos de garantia / Garantiejaar / Jahr der Garantie / Year of guarantee

** réparable / reparable / reparável / riparabile / διορθώσιμος / naprawiany / ремонтний / reparabil / reparaturfähig /
reparável / herstelbaar / reparierbar / repairable

2025-05-V01



FR : assemblage / **ES :** ensamble / **PT :** montagem / **IT :** assemblaggio /
EL : συναρμολόγηση / **PL :** montaż / **UA :** збірка / **RO :** asamblare /
BR : montagem / **NL :** samenstelling / **DE :** Montage / **EN :** assembly



1 / 2

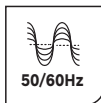
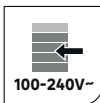

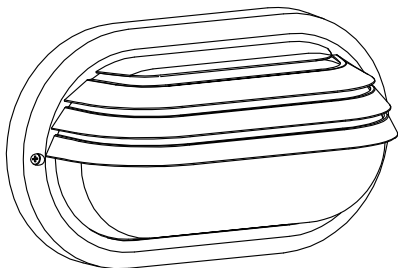

N°1-5mm

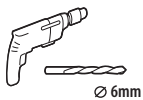

Ø 6mm

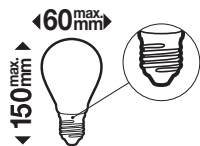
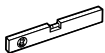

E27 MAX 25W

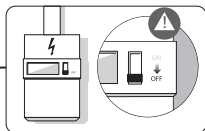

1

1

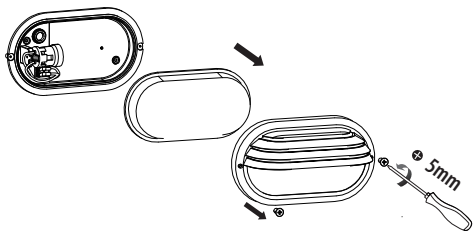

2

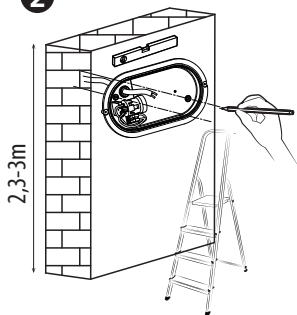

3

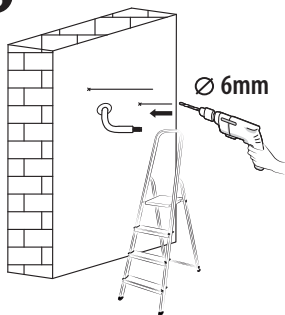

2

4

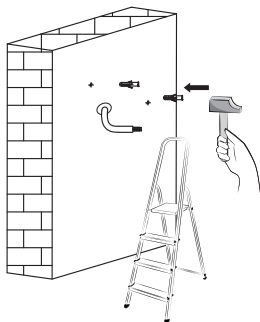

5

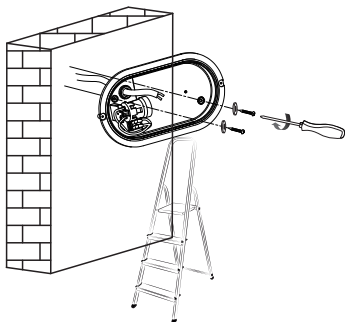

FR - Utiliser des vis et des chevilles adaptées à votre support. / **ES** - Utilice tacos y tornillos adecuados al soporte. / **PT** - Utilize buchas e parafusos adequado ao seu suporte. / **IT** - Utilizzare viti e tasselli adatti per il retro. / **GR** - Χρησιμοποιήστε βίδες και βύσματα που ταιριάζουν στην επιφάνεια στήριξης. / **PL** - Należy użyć śrub i kołków odpowiednich dla podłoża. / **UA** - Використовуйте гвинти та шканти, призначені для задньої поверхні. / **RO** - Utilizați șuruburi și dibluri adecvate pentru suportul dvs. / **BR** - Use parafusos e buchas adequados para seu suporte. / **NL** - Gebruik schroeven en pluggen die geschikt zijn voor uw ondergrond. / **DE** - Verwenden Sie für Ihre Unterlage geeignete Schrauben und Dübel. / **EN** - Use screws and dowels suited to your backing.

6

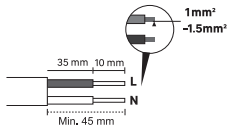
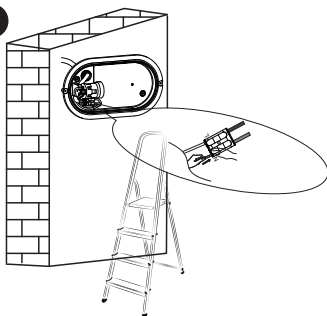

N =Bleu/Azul/Azul/Blu/Μπλε/Niebieski/Синій/Albastru/ Blauw/Blau/Blue

L =Marron/Marrón/Castanho/Marrone/Καφέ/Brązowy/
Коричневий/Maro/Marrom/bruin/Braun/Brown

3

7

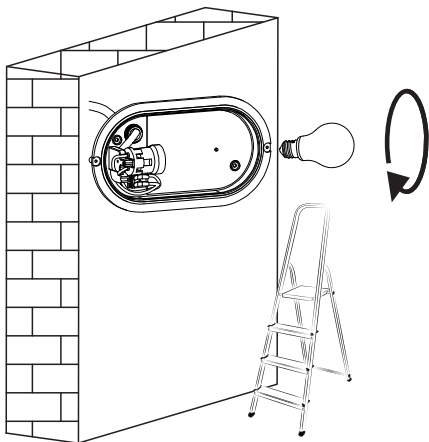

8

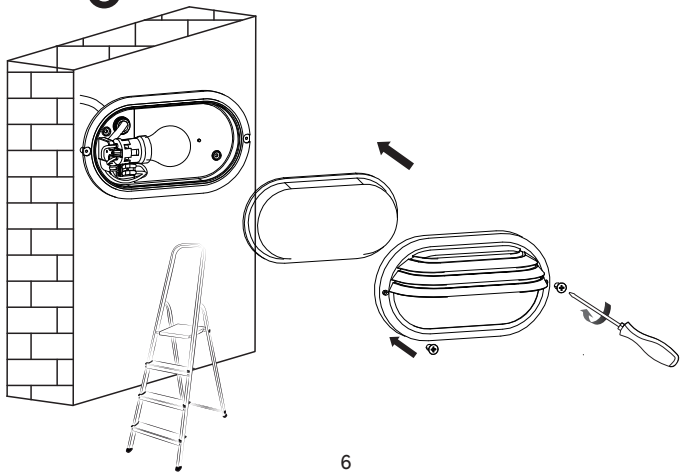

6

4

9

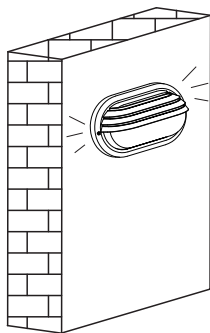
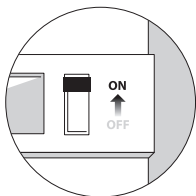



Points de collecte sur www.quefairedemesdechets.fr
Privilégiez la réparation ou le don de votre appareil !

FR: Traduction de la version originale du mode d'emploi / ES: Traducción de las Instrucciones originales / PT: Tradução das Instruções Originais / IT: Traduzione delle istruzioni originali / EL: Μετάφραση των πρωτότυπων οδηγιών / PL: Tłumaczenie instrukcji oryginalnej / UA: Переклад оригінальної інструкції / RO: Traducerea instrucțiunilor originale / BR: Tradução das Instruções Originais / DE: Übersetzung der Originalversion der Gebrauchsanweisung / Original Instructions.

Made in China

Країна походження: Китай

EU - ADEO Services - 135 Rue Sadi Carnot - CS00001 - 59790 RONCHIN - FRANCE

www.product-regulatory.adeoservices.com

UA-Виробник: ТОВ «Адео Сервісез С.А.», вул. Саді Карно, CS 00001, 59790 Роншен, Франція. Імпортер, суб'єкт господарювання, що відповідає за виконання гарантійних зобов'язань: ТОВ «Леруа Мерлен Україна», 04201 Україна, м. Київ, вул. Полярна 17А, +380 44 498 46 00.

BR-IMPORTADO E DISTRIBUÍDO POR: LEROY MERLIN COMPANHIA BRASILEIRA DE BRICOLAGEM CNPJ: 01.438.784/0001-05 Rua Pascoal Pais, nº. 525, 6º andar, cj 61 a 64 - Vila Cordeiro, São Paulo - SP CEP: 04581-060 CALM (Central de Atendimento Leroy Merlin) Capitais 4020-5376 Demais Regiões 0800-0205376

ZA-Imported by Adeo South Africa (PTY) LTD T/A Leroy Merlin, Hosted in Leroy Merlin Fourways Store 35 Roos Street, Witkoppen Ext 97, Sandton, 2191 Johannesburg, Gauteng, South Africa. Tel: +27 10 493 8000 Email: contact@leroymerlin.co.za.

