

**Ánodo de sacrificio**  
 protegemos de la corrosión  
 las superficies de la grifería

**Galvanic anode**  
 we protect plumbing  
 from corrosion

**Anode sacrificielle**  
 nous protégeons les  
 surfaces des robinets de la  
 corrosion

**Zink-Magnesium-Anode**  
 Schützt die Oberflächen der  
 Armaturen vor Korrosion

**O ânodo de sacrificio**  
 protege as superfícies dos  
 equipamentos contra a  
 corrosão

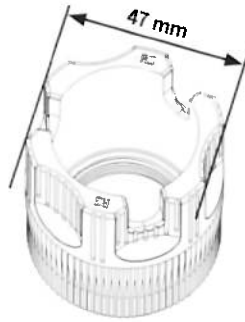
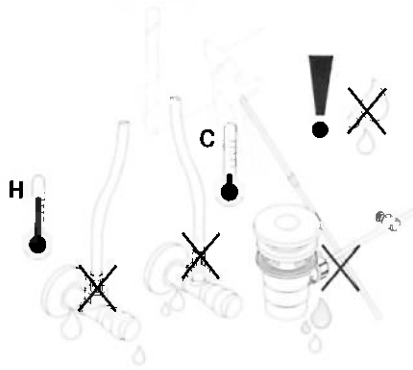
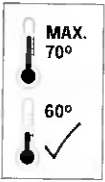
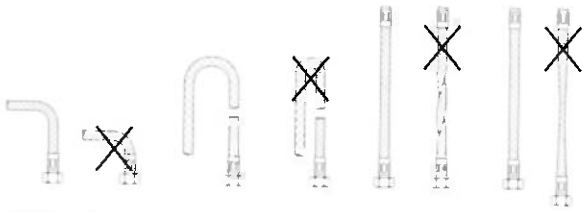

AAZ305358

AAZ305357





SIN HERRAMIENTAS  
TOOL-LESS  
SANS OUTIL  
OHNE WERKZEUG

SENSE EINES  
**SEM FERRAMENTAS**  
Без использования инструментов  
بدون استخدام أدوات تركيب

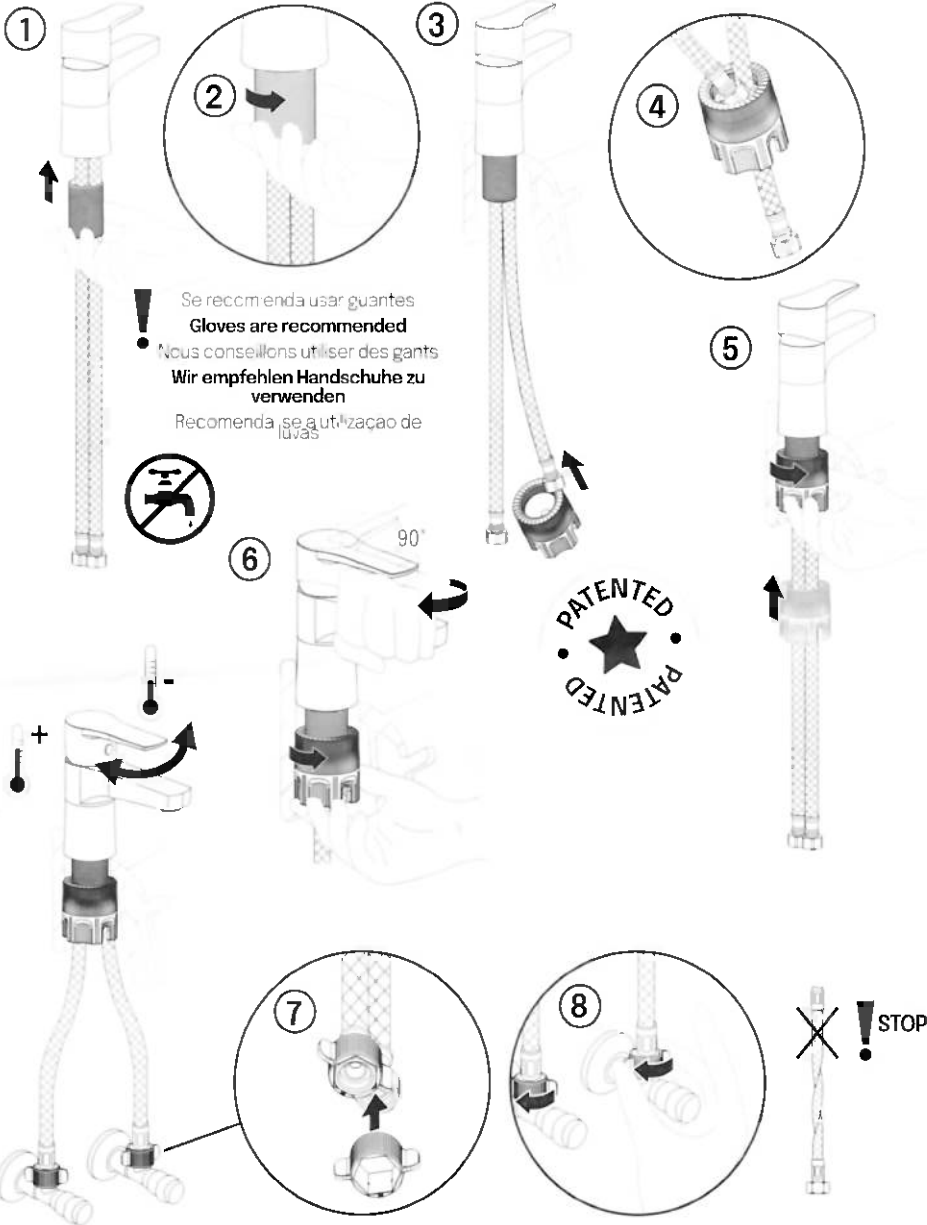

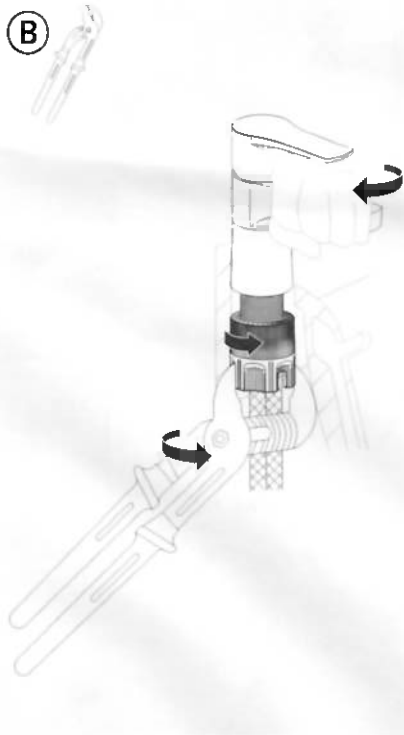
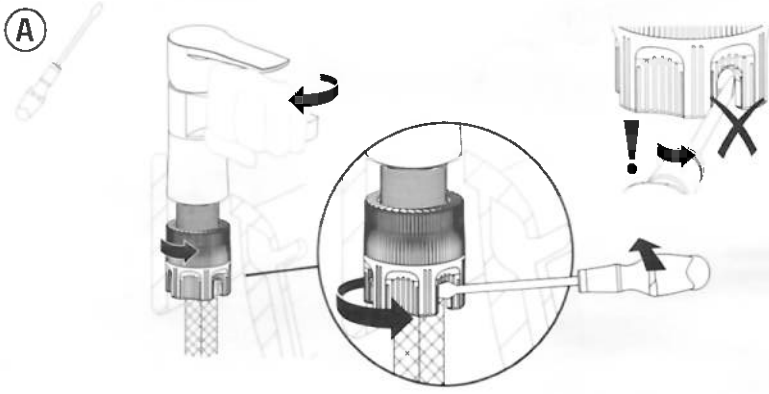

ramonsoler.