

↖ 18 ↔ 60

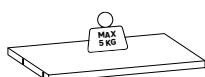

↖ 28 ↔ 40

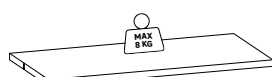

↖ 28 ↔ 60

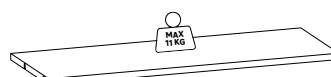

↖ 28 ↔ 80

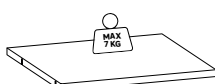

↖ 38 ↔ 40



↖ 38 ↔ 60

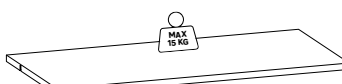

↖ 38 ↔ 80



↖ 54 ↔ 40

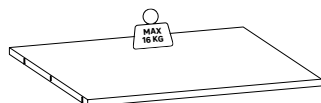

↖ 54 ↔ 60

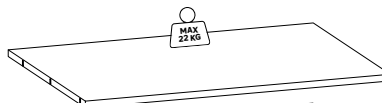

↖ 54 ↔ 80



**Made in France**

FR Manuel d'instructions

ES Manual de instrucciones

PT Manual de instruções

IT Manuale di istruzioni

EL Εγχειρίδιο οδηγιών

PL Instrukcja obsługi

EN Instruction manual

RO Manual de instrucțiuni

\*Garantie 15 ans / Garanzia di 15 anni / 15-year guarantee / 15 años de garantía / Εγγύηση 15 ετών /  
 Garanție de 15 ani / Garantia de 15 anos / 15-letnia gwarancja

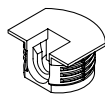
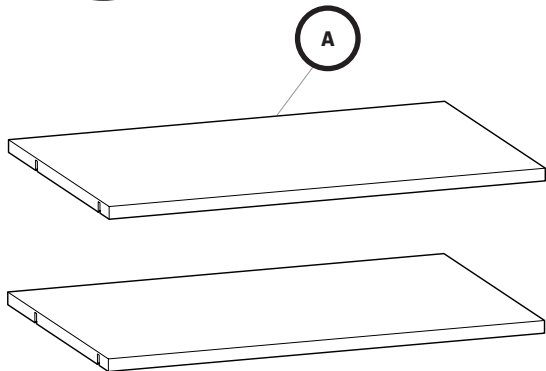
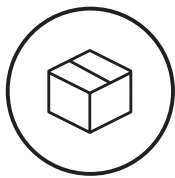

0002-0017 x 8 (↖, 18, 28, 38) x 12 (↖, 54)  
 0002-0018 x 8 (↖, 18, 28, 38) x 12 (↖, 54)

FR IMPORTANT, à conserver pour consultation ultérieure : à lire attentivement

ES IMPORTANTE, conservar para consultar posteriormente: leer atentamente

PT IMPORTANTE, conservar para futuras consultas: por favor, leia com atenção

IT IMPORTANTE, da conservare per ulteriore consultazione: da leggere attentamente

EL ΣΗΜΑΝΤΙΚΟ, κρατήστε το για μελλοντική αναφορά. Διαβάστε το προσεκτικά

PL WAŻNE, przeczytać uważnie i zachować na przyszłość

RO IMPORTANT, a se pastra pentru consultarea ulterioara: citiți cu atenție

EN IMPORTANT, to be retained for future reference: please read carefully

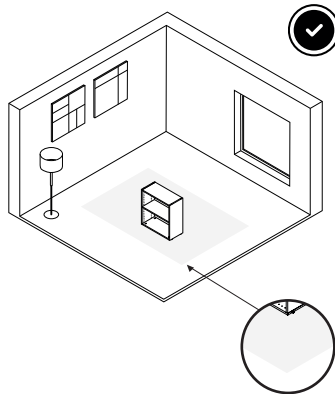
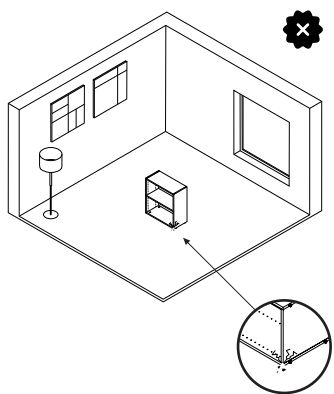

FR Protection pour montage  
 ES Protección para montaje  
 PT Proteção para montagem  
 IT Protezione per il montaggio  
 EL Προστασία για συναρμολόγηση  
 PL Bez listew przypodłogowych  
 RO Protecție pentru asamblare  
 EN Protection for assembly

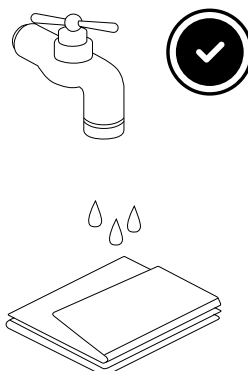
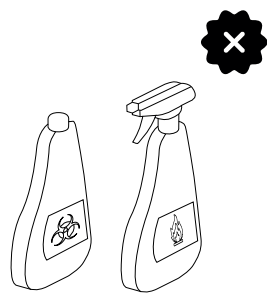
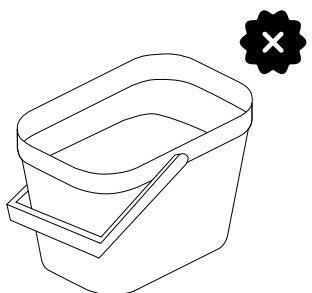



0002-0018  
x 8 (↖ 18, 28, 38)

x 12 (↖ 54)

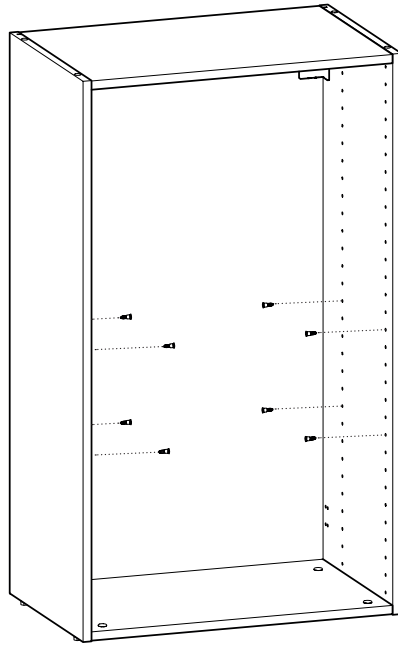

01

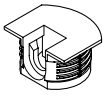

0002-0017  
x 8 (↖ 18, 28, 38)

x 12 (↖ 54)

02

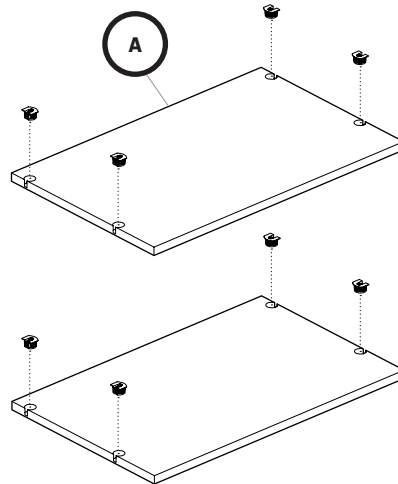

03

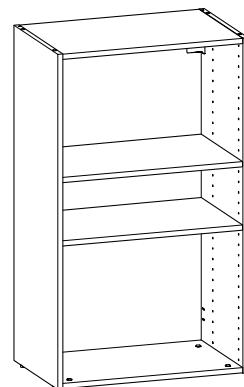
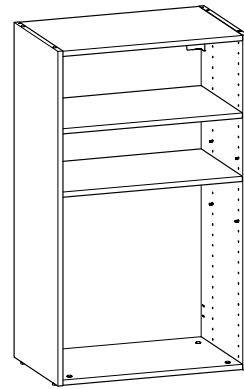



**FR** Ce meuble se recycle, s'il n'est plus utilisable, déposez-le en déchèterie. Notice à trier. Pour en savoir plus : [www.quefairedemesdechets.fr](http://www.quefairedemesdechets.fr)



**FR** **Etiquette de traçabilité présente sur le produit.**  
**Référence à communiquer en cas de demande.**

- ES** Si ya no puede utilizarse, este mueble se puede reciclar, depositelo en la unidad de clasificación de residuos.
- PT** Este móvel é reciclável. Quando deixar de ser utilizado, deposite-o num centro de reciclagem de resíduos.
- IT** Questo mobile può essere riciclato, portatelo in un'isola ecologica se inutilizzabile.
- EL** ο έπιπλο αυτό είναι ανακυκλώσιμο, εάν δεν μπορεί πλέον να χρησιμοποιηθεί τοποθετήστε το σε χώρο αποβλήτων.
- PL** Mebel ten poddawany jest recyklingowi, kiedy przestaje być użyteczny należy go dostarczyć do punktu zbiórki odpadów.
- RO** Această piesă de mobilier este reciclabilă. Dacă nu mai poate fi folosită, vă rugăm să o duceți la centrul de reciclare a deșeurilor.
- EN** This piece of furniture is recyclable. If it cannot be used anymore, please take it to the waste recycling centre.

- ES** El producto cuenta con una etiqueta de trazabilidad. En caso de reclamación, indicar esta referencia.
- PT** Etiqueta de reatrabilidade presente no produto. Referência a comunicar se solicitado.
- IT** Etichetta di tracciabilità presente sul prodotto. Codice da comunicare in caso di domanda.
- EL** τικέτα ιχνηλασιμότητας πάνω στο προϊόν. κωδικός αναφοράς πρέπει να αναφέρεται σε περίπτωση αιτήματος.
- PL** Etykieta identyfikacyjna znajduje się na produkcie. Dane referencyjne należy podać w przypadku pytań.
- RO** Etichetă de trasabilitate prezentă pe produs. Dacă se solicită, comunică această referință.
- EN** Traceability label affixed to the product. Reference to quote if requested.

**15**  
**YEAR**  
Guarantee\*

- FR** **Garantie 15 ans**
- ES** Garantía 15 años
- PT** Garantia 15 anos
- IT** Garanzia 15 anni
- EL** Εγγύηση 15 ετών
- PL** Gwarancja 15 lata
- RO** Garanție 15 ani
- EN** 15 years warranty

Imported by Adeo South Africa (PTY) LTD T/A Leroy Merlin, Hosted in Leroy Merlin Fourways Store, 35 Roos Street, Witkoppen Ext 97, Sandton, 2191 Johannesburg, Gauteng, South Africa. Tel: +27 10 493 8000 Email: [contact@leroymerlin.co.za](mailto:contact@leroymerlin.co.za)

## Adeo Services

135, rue Sadi Carnot  
CS 00001

59790 Ronchin - France

[www.product-regulatory.adeoservices.com](http://www.product-regulatory.adeoservices.com)



<https://quefairedemesdechets.fr>