

**E** INSTRUCCIONES DE MONTAJE

**I** INTRUZIONI DI MONTAGGIO

**F** INSTRUCTIONS DE MONTAGE

**P** INSTRUCAO DE MONTAGEM

**GB** INSTALLATION INSTRUCTIONS

ME10S01



20  
COMPLEMENTOS DECORATIVOS DEL  
BAÑO, S.L.  
Avda. Can Roqueta 70, 08202 Sabadell, Barcelona,  
España

DdP nº 4

UNE-EN 14428:2016+A1:2019

Higiene Personal

Endurancia: cumple  
Estabilidad: cumple  
Etiquetado: cumple

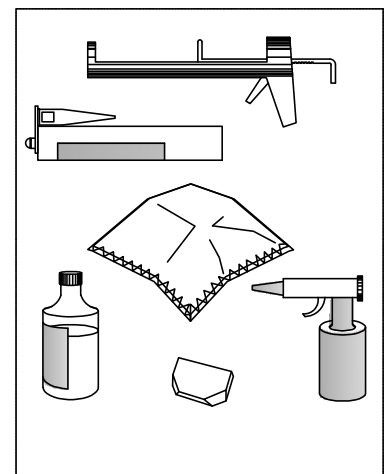
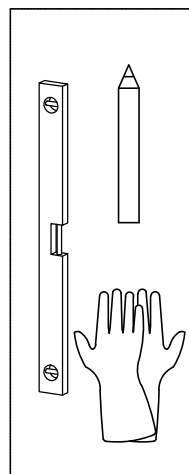
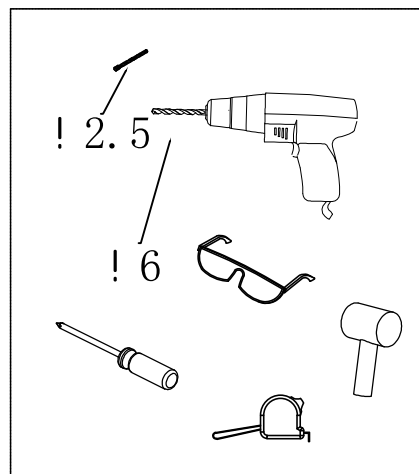
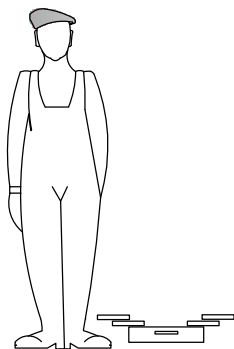
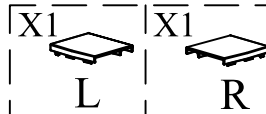
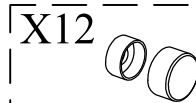
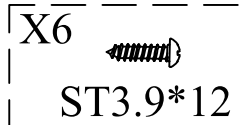
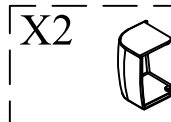
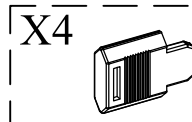
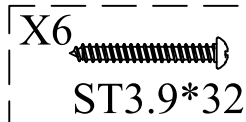
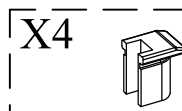
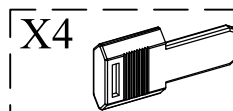
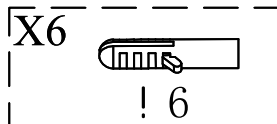
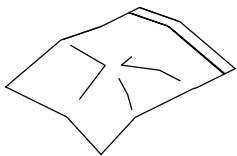
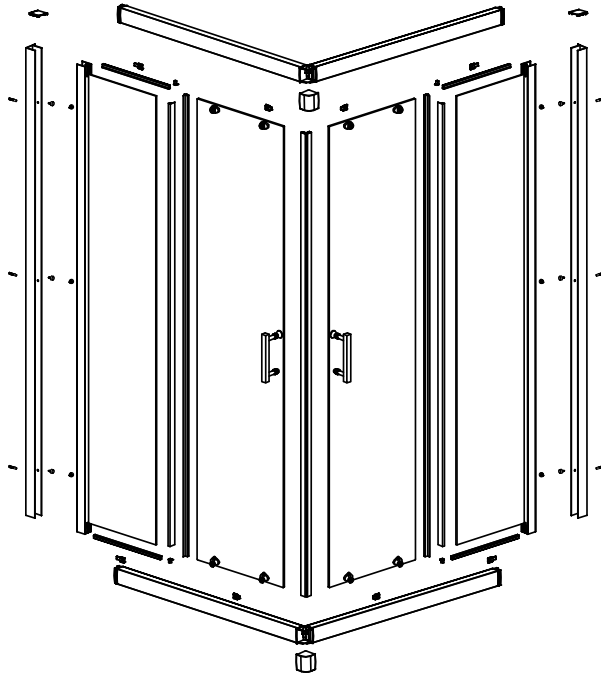
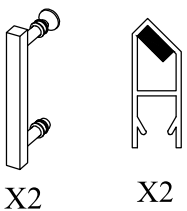
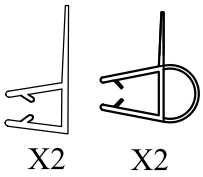
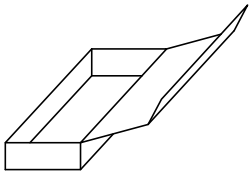

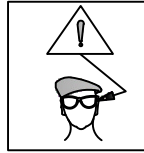
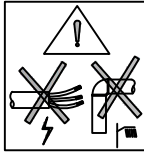
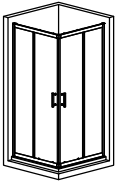

ME10S01

1

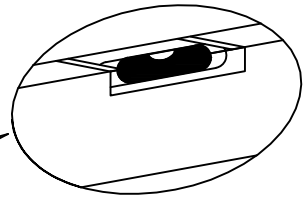
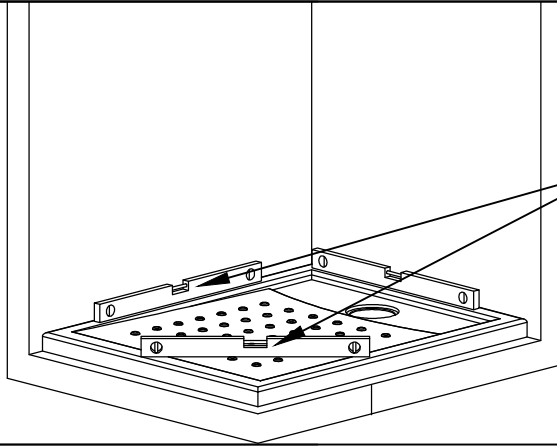
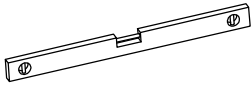

2

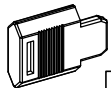

X4



X2

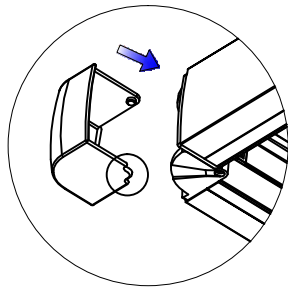

UP

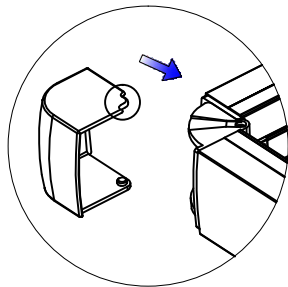
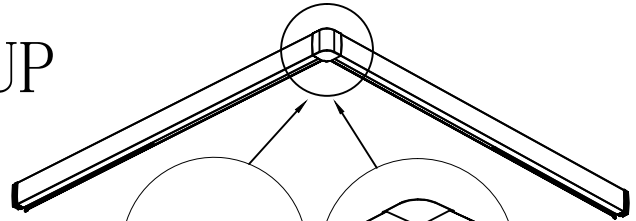

DOWN

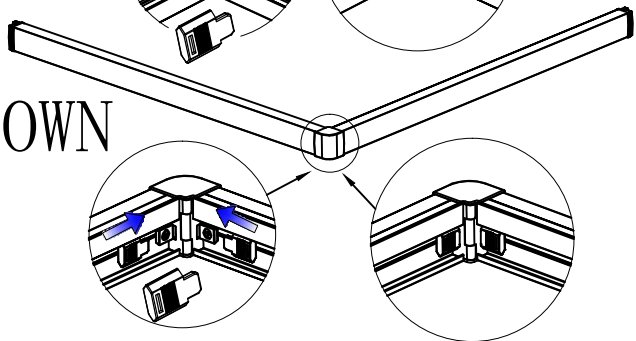

3

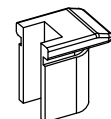
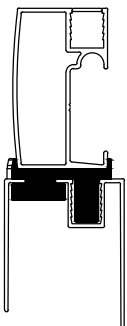

X2

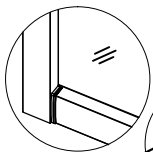
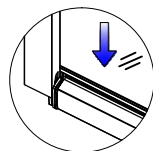
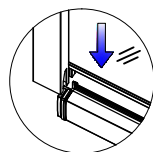

Outside

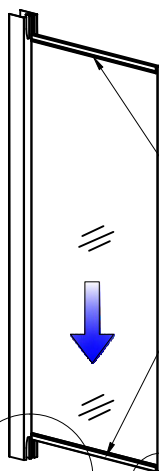

3.1

3.2

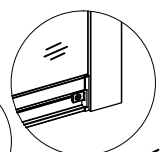
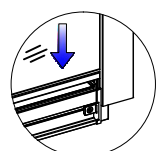
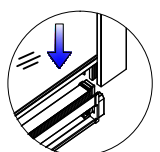
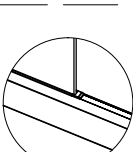
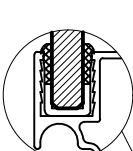
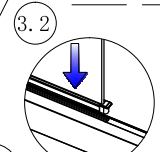
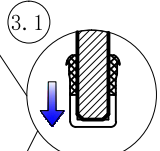

Inside

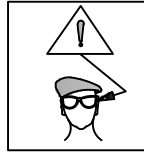
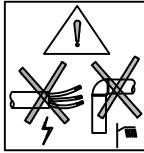
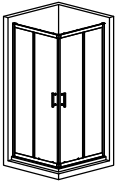

ME10S01

4

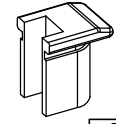

X2

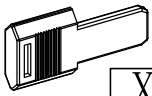

X4

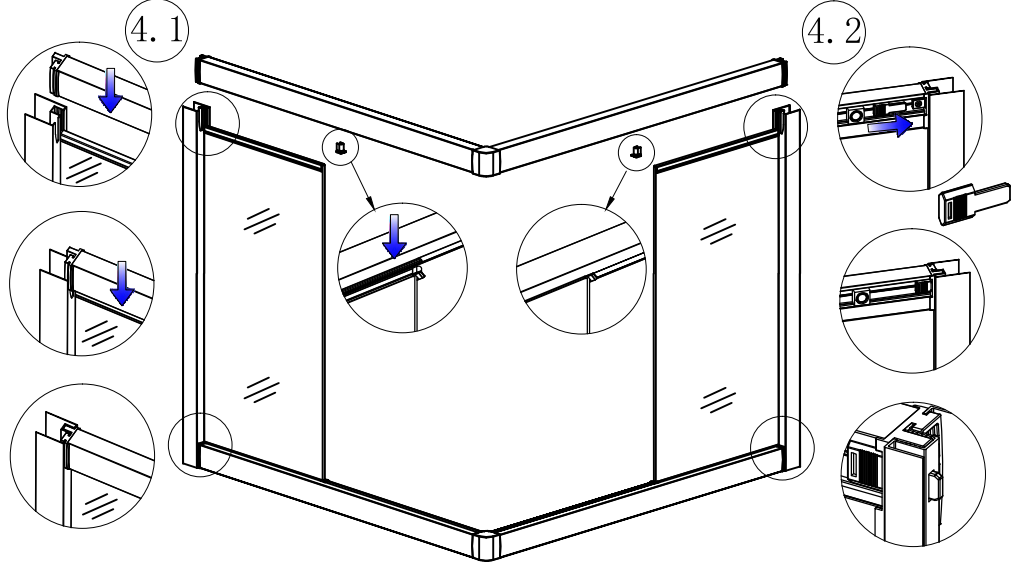

5

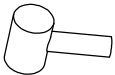
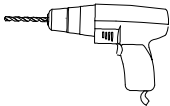
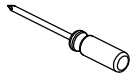
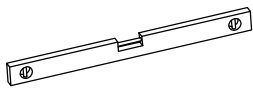

ST3. 9\*32 X6



X6

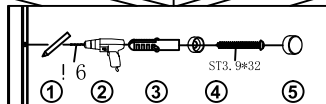
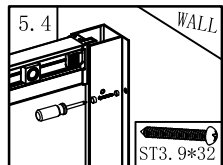
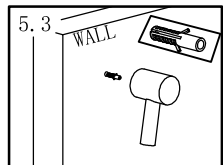
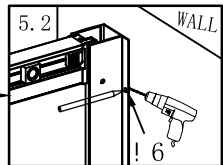
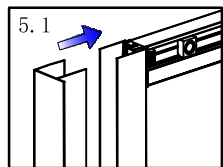
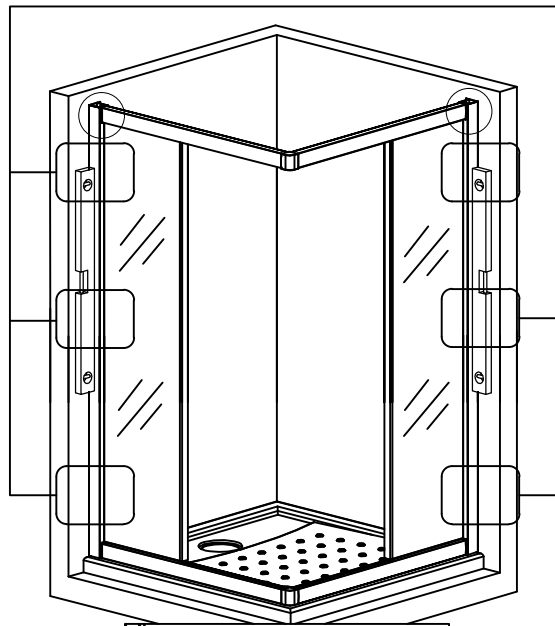

6

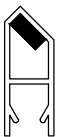

X 2

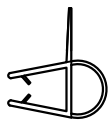

X 2

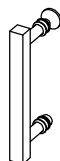

X 2

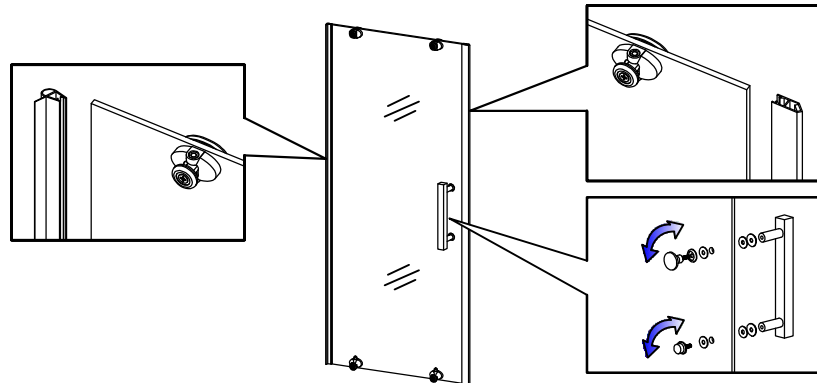

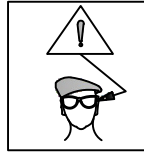
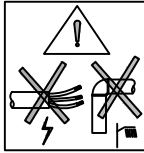
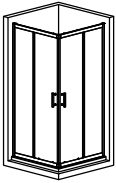

ME10S01



X 2

7

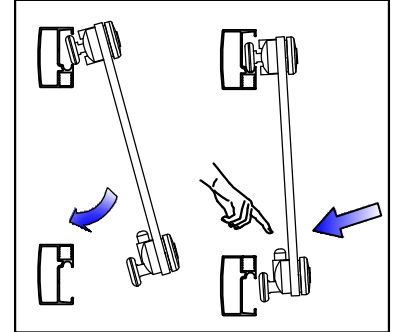
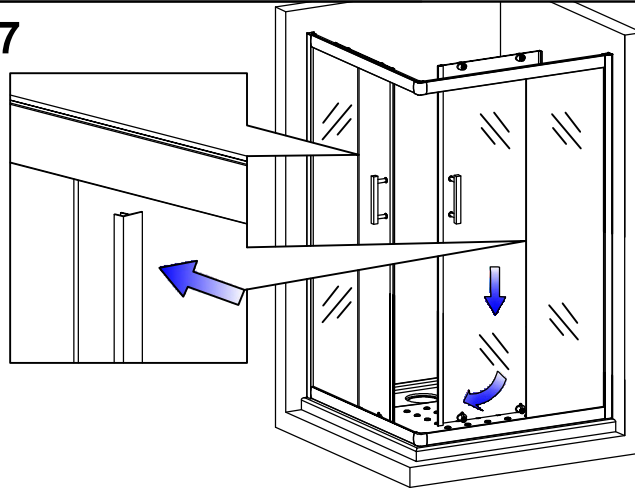

8

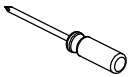
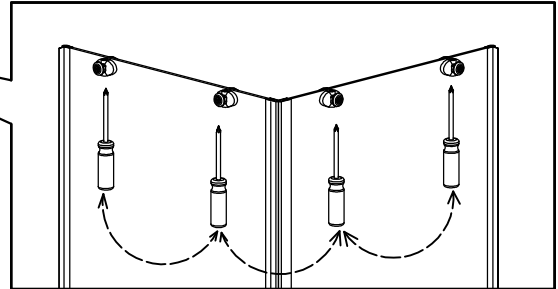
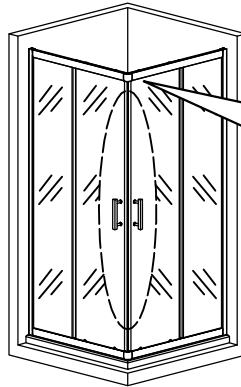

9

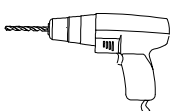
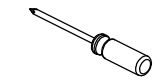
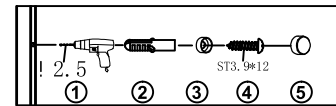
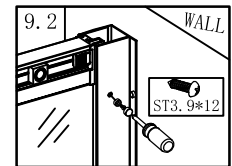
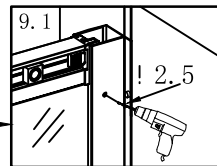
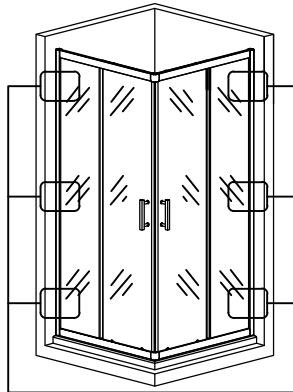

X6

ST3. 9\*12



X6

10

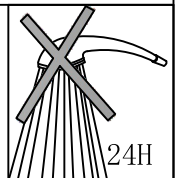
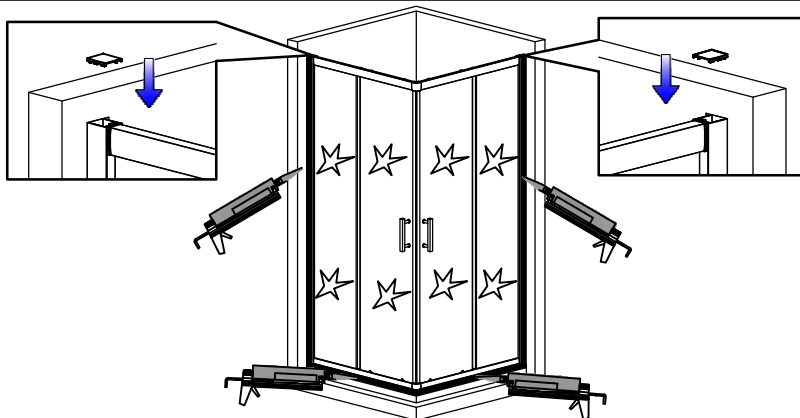

24H

