

# ASSEMBLY INSTRUCTIONS

INSTRUCCIONES DE MONTAJE / INSTRUCTIONS DE MONTAGE

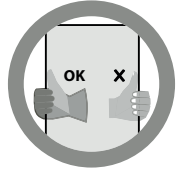

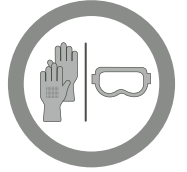
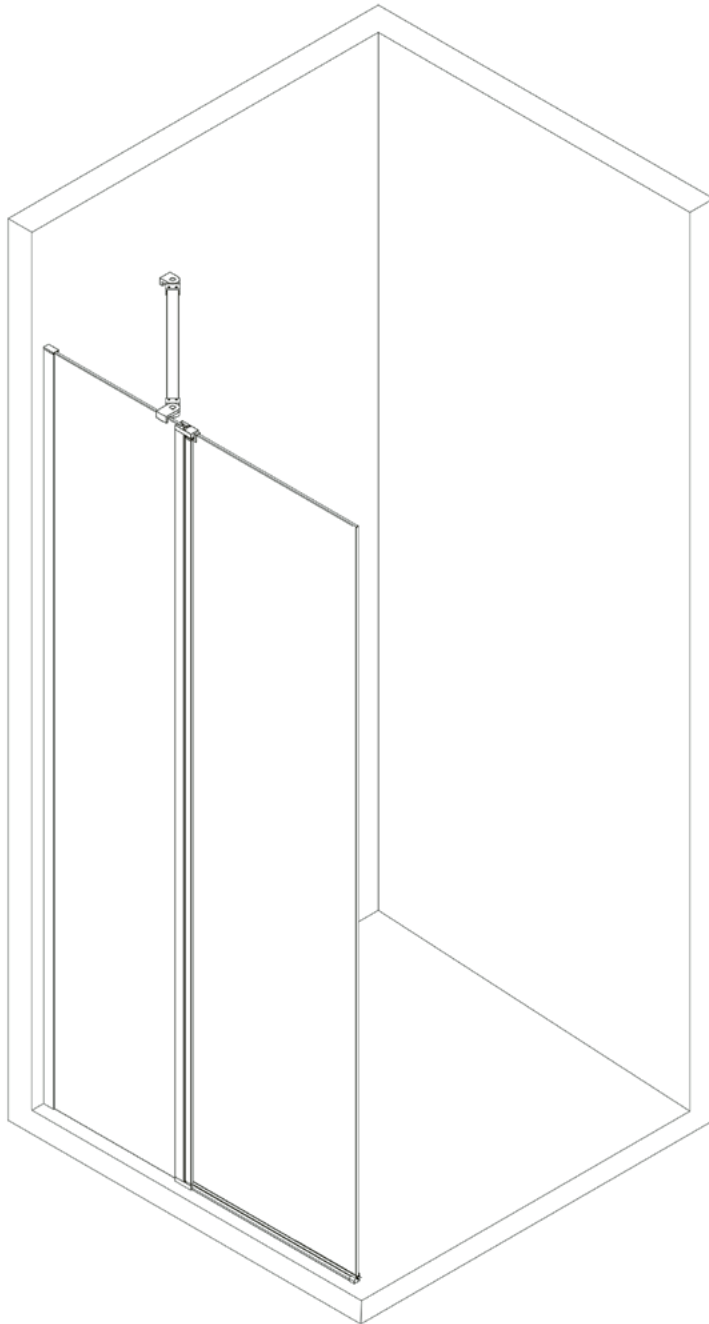
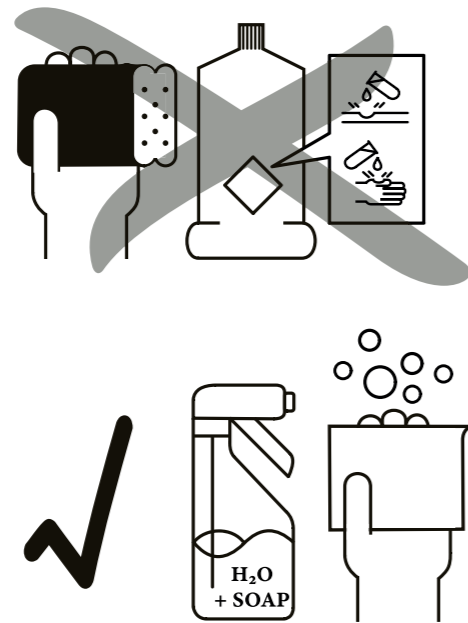

**IMPORTANT NOTE\_ CLEANING THE SHELF / NOTA IMPORTANTE\_ LIMPIEZA DE LA MAMPARA / NOTE IMPORTANTE\_ NETTOYAGE DE L'ÉTAGERE**

Always clean your SCREEN with neutral soaps and water. Other types of products can damage serigraphs, rubber bands, profiles and even the anti-crystalline treatments of the crystals in case of wearing them. Always clean the metal parts with a soft cloth, do not use scourers, it will cause scratches.

Limpie su MAMPARA siempre con jabones neutros y agua. Otro tipo de productos pueden dañar serigrafías, gomas de estanqueidad, perfiles e incluso los tratamientos anticál de los cristales en caso de llevarlos. Limpiar siempre las piezas metálicas con un paño suave, no utilizar estropajos, provocaría arañazos.

Nettoyez toujours votre PAROI avec du savon neutre et de l'eau. D'autres types des produits peuvent endommager les sérigraphies, les joints, les profils etc, même les traitements anti-calcaires de verre peuvent abimer la paroi. Nettoyez toujours les parties métalliques avec un chiffon doux. N'utilisez pas d'éponges dures qui peuvent causer des égratignures.

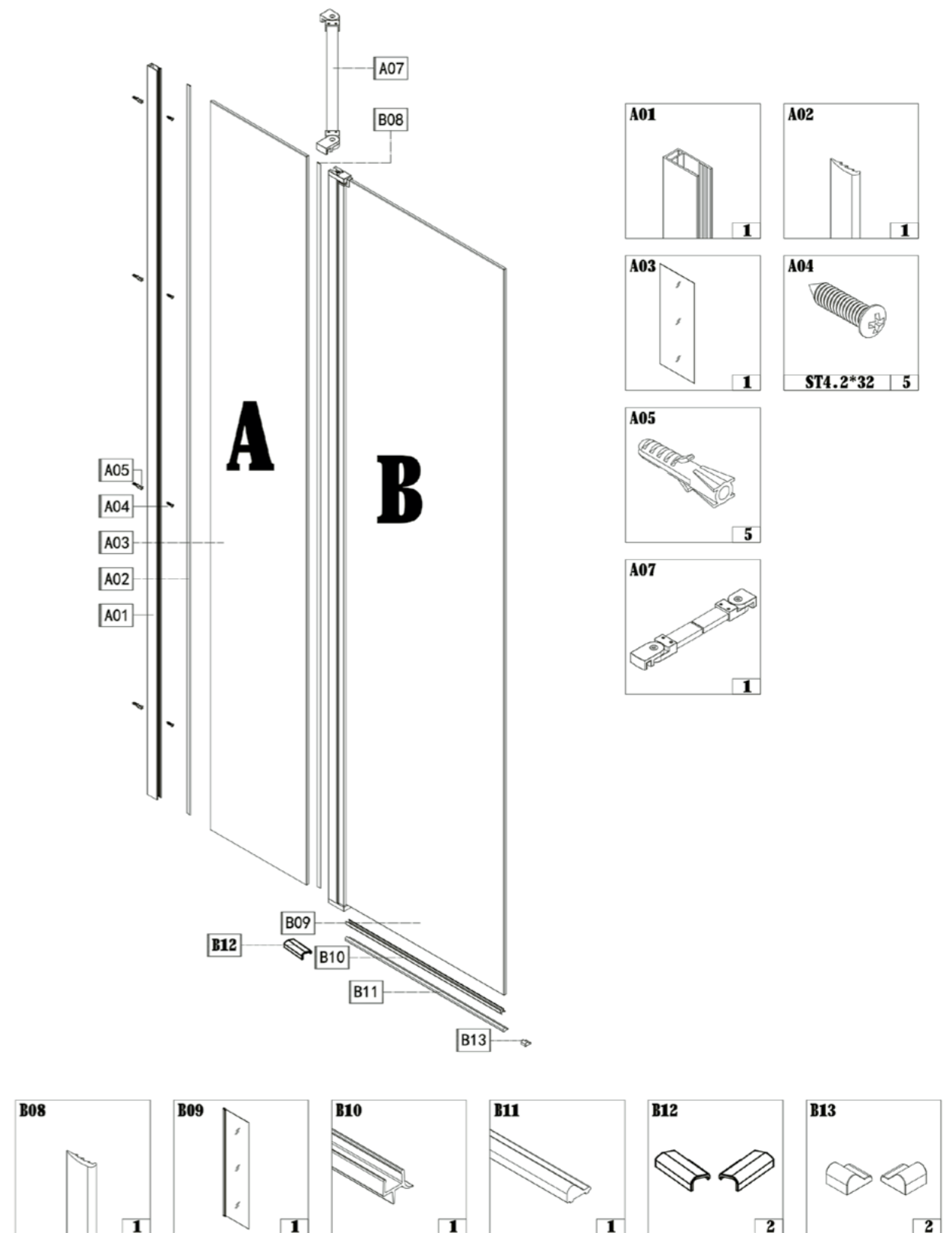

1

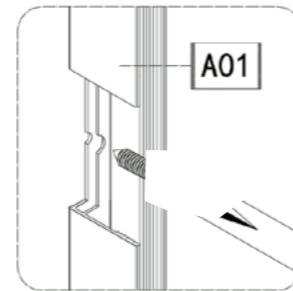
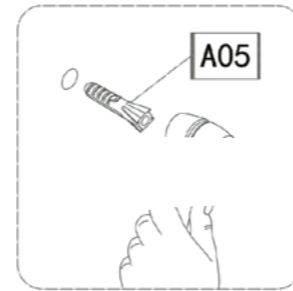
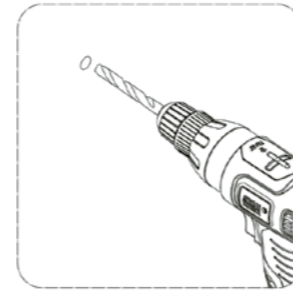
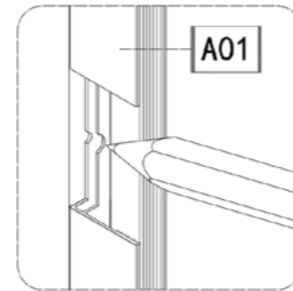
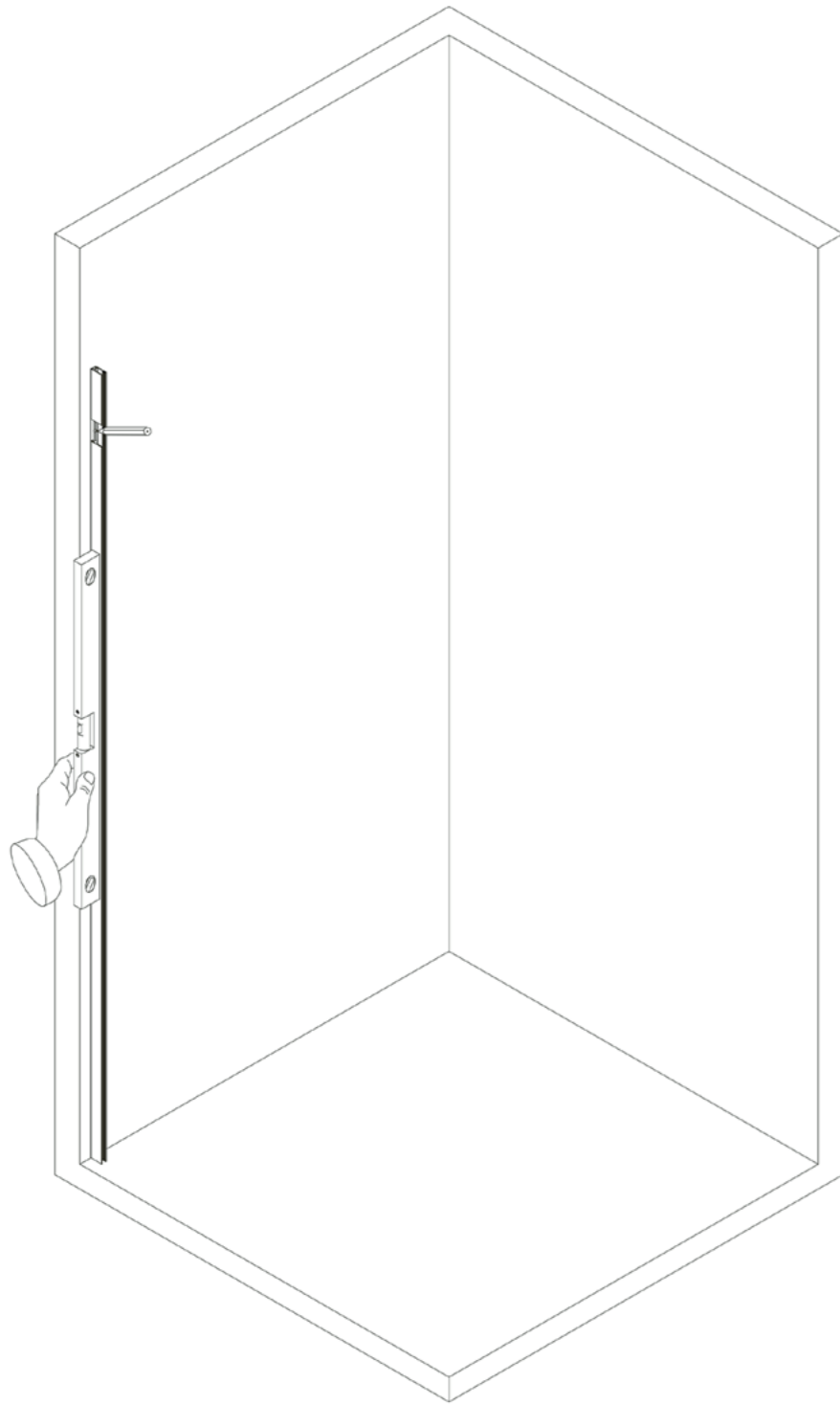

2

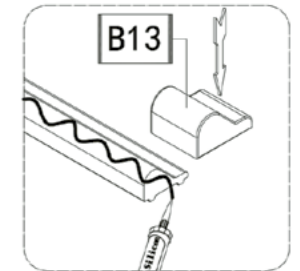
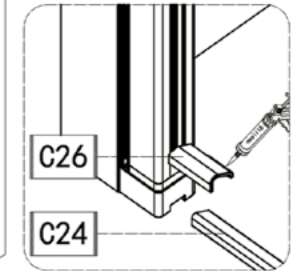
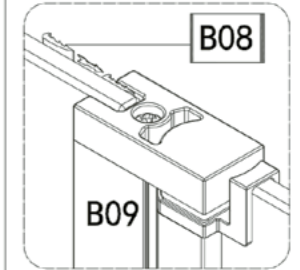
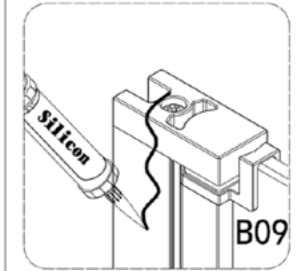
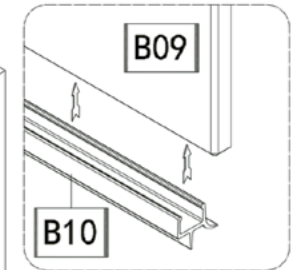
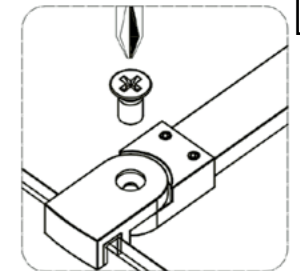
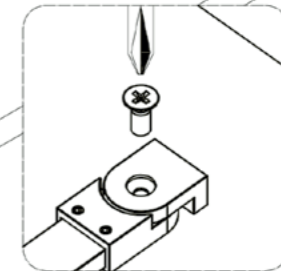
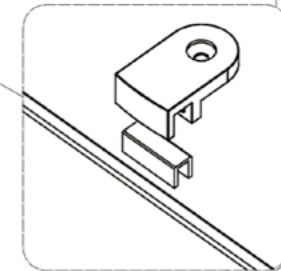
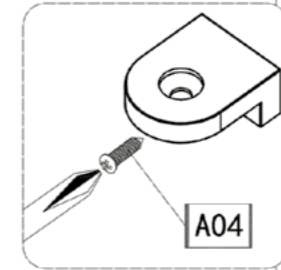
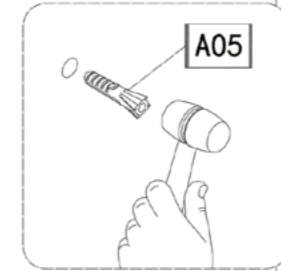
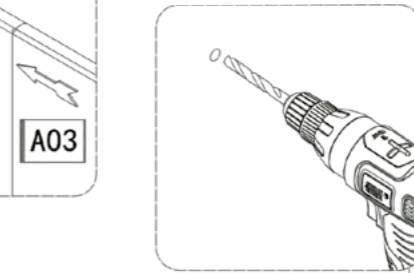
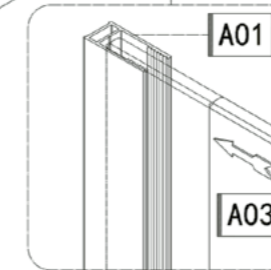
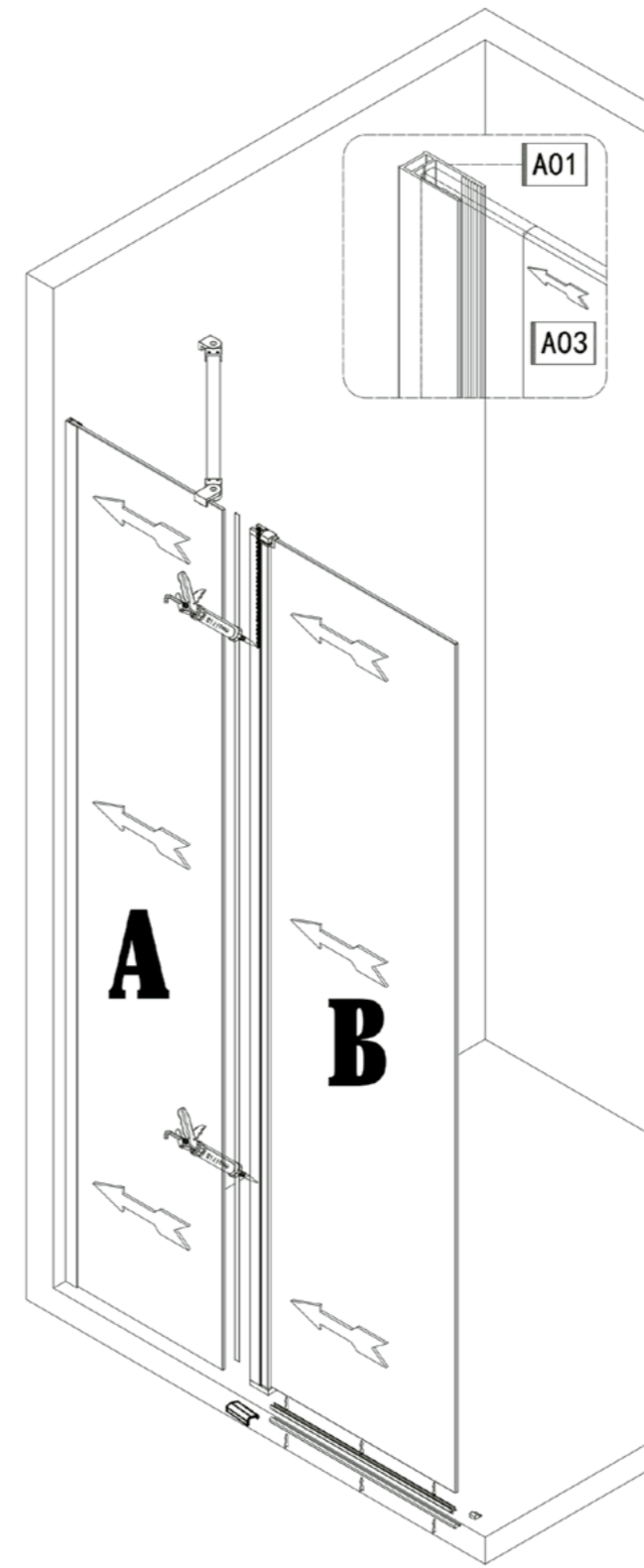

3

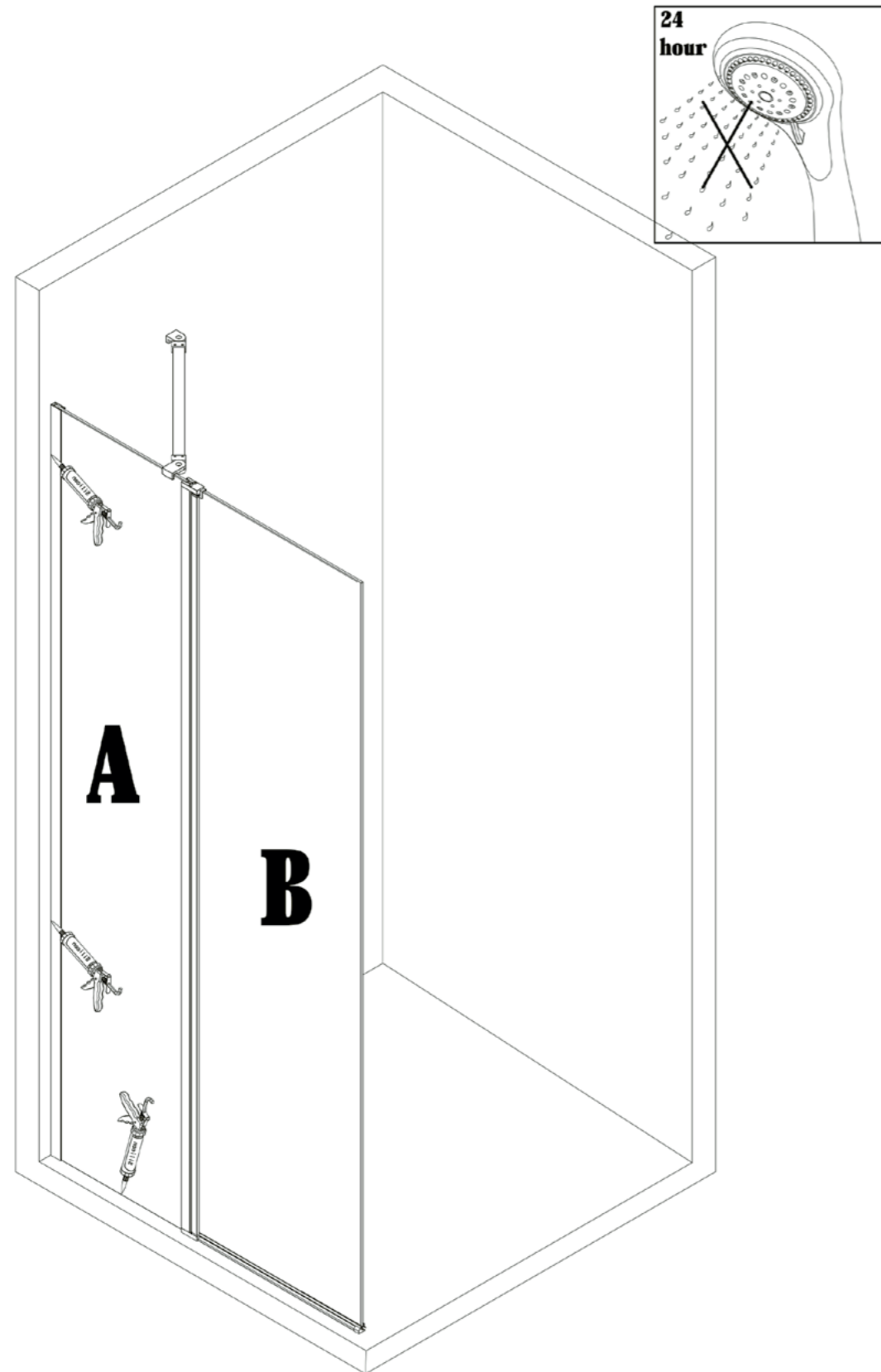



# ASSEMBLY INSTRUCTIONS

INSTRUCCIONES DE MONTAJE / INSTRUCTIONS DE MONTAGE

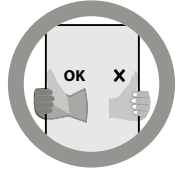
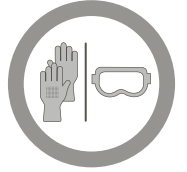
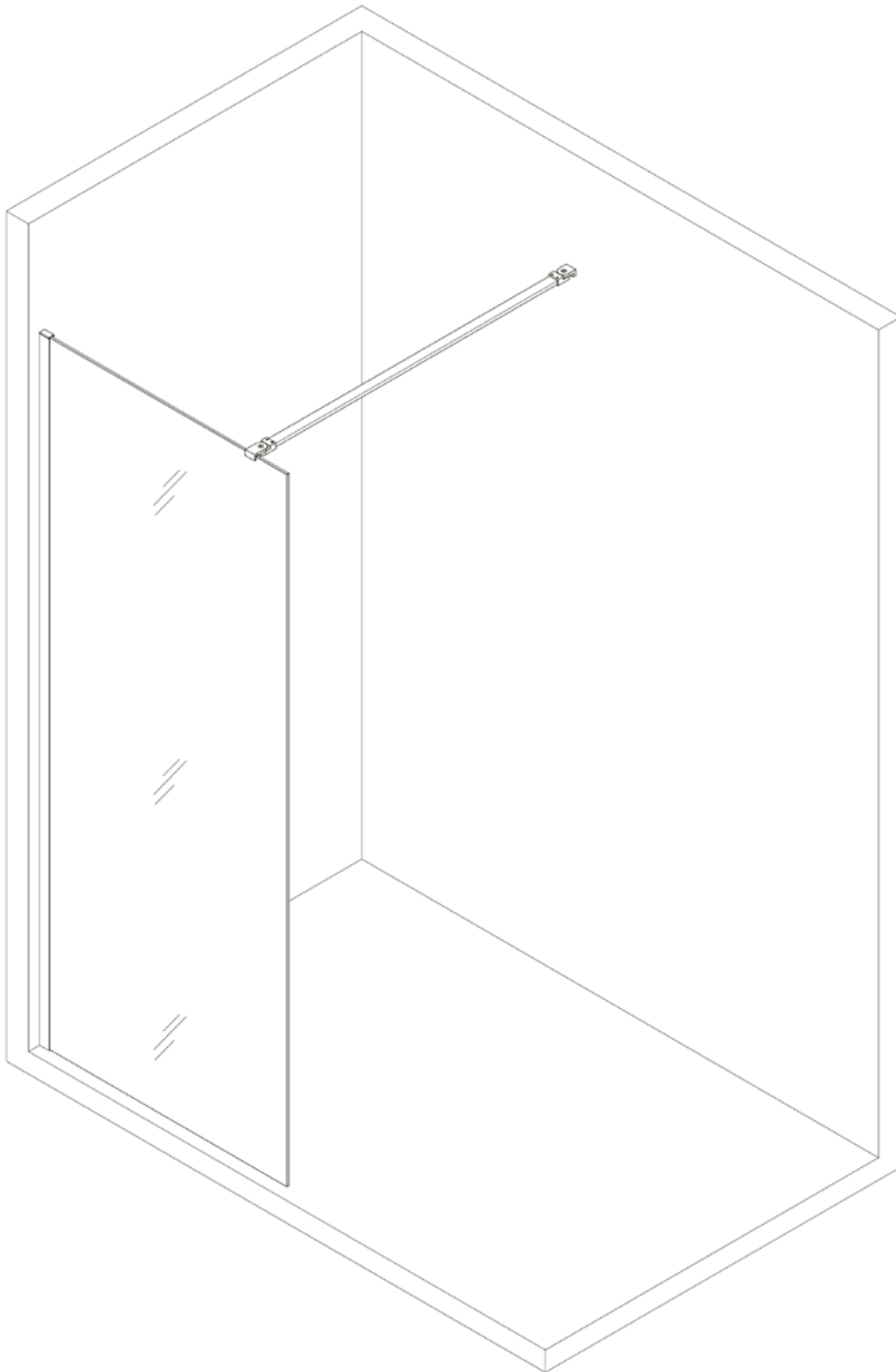

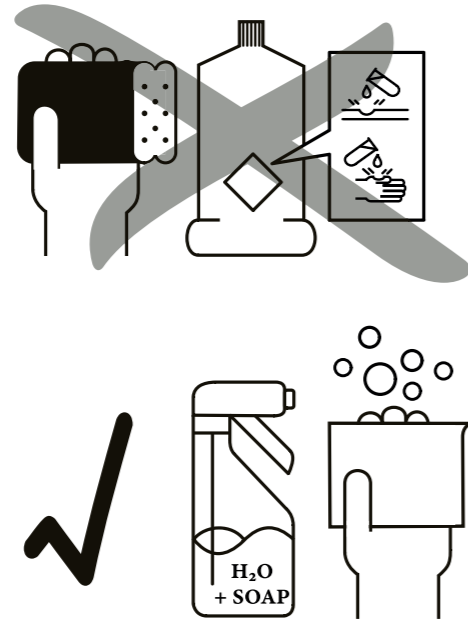

**IMPORTANT NOTE\_ CLEANING THE SHELF / NOTA IMPORTANTE\_ LIMPIEZA DE LA MAMPARA / NOTE IMPORTANTE\_ NETTOYAGE DE L'ÉTAGERE**

Always clean your SCREEN with neutral soaps and water. Other types of products can damage serigraphs, rubber bands, profiles and even the anti-crystalline treatments of the crystals in case of wearing them. Always clean the metal parts with a soft cloth, do not use scourers, it will cause scratches.

Limpe su MAMPARA siempre con jabones neutros y agua. Otro tipo de productos pueden dañar serigrafías, gomas de estanqueidad, perfiles e incluso los tratamientos anticorrosivos de los cristales en caso de llevarlos. Limpiar siempre las piezas metálicas con un paño suave, no utilizar estropajos, provocaría arañazos.

Nettoyez toujours votre PAROI avec du savon neutre et de l'eau. D'autres types des produits peuvent endommager les sérigraphies, les joints, les profils etc, même les traitements anticorrosifs de verre peuvent abimer la paroi. Nettoyez toujours les parties métalliques avec un chiffon doux. N'utilisez pas d'éponges dures qui peuvent causer des égratignures.

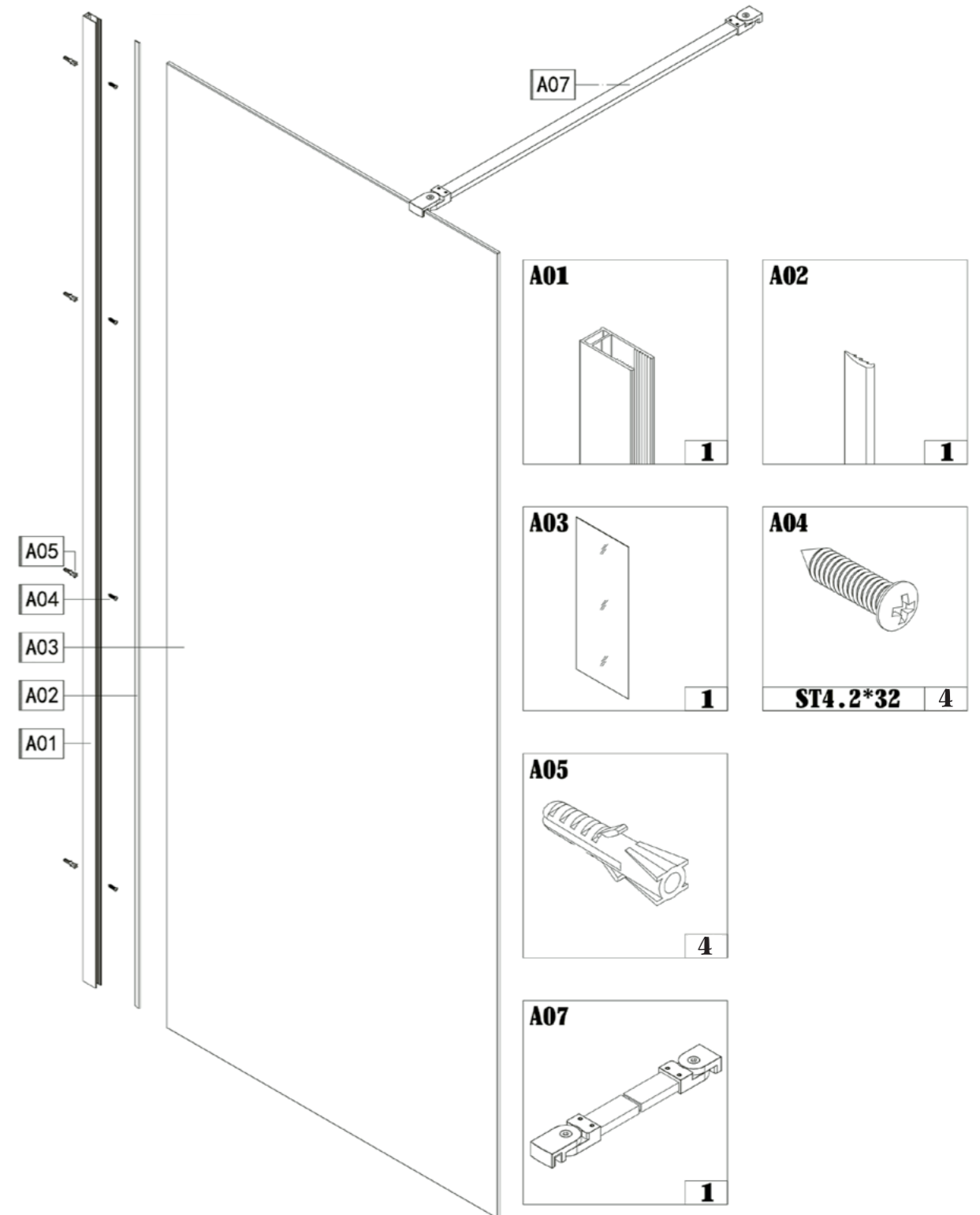

1

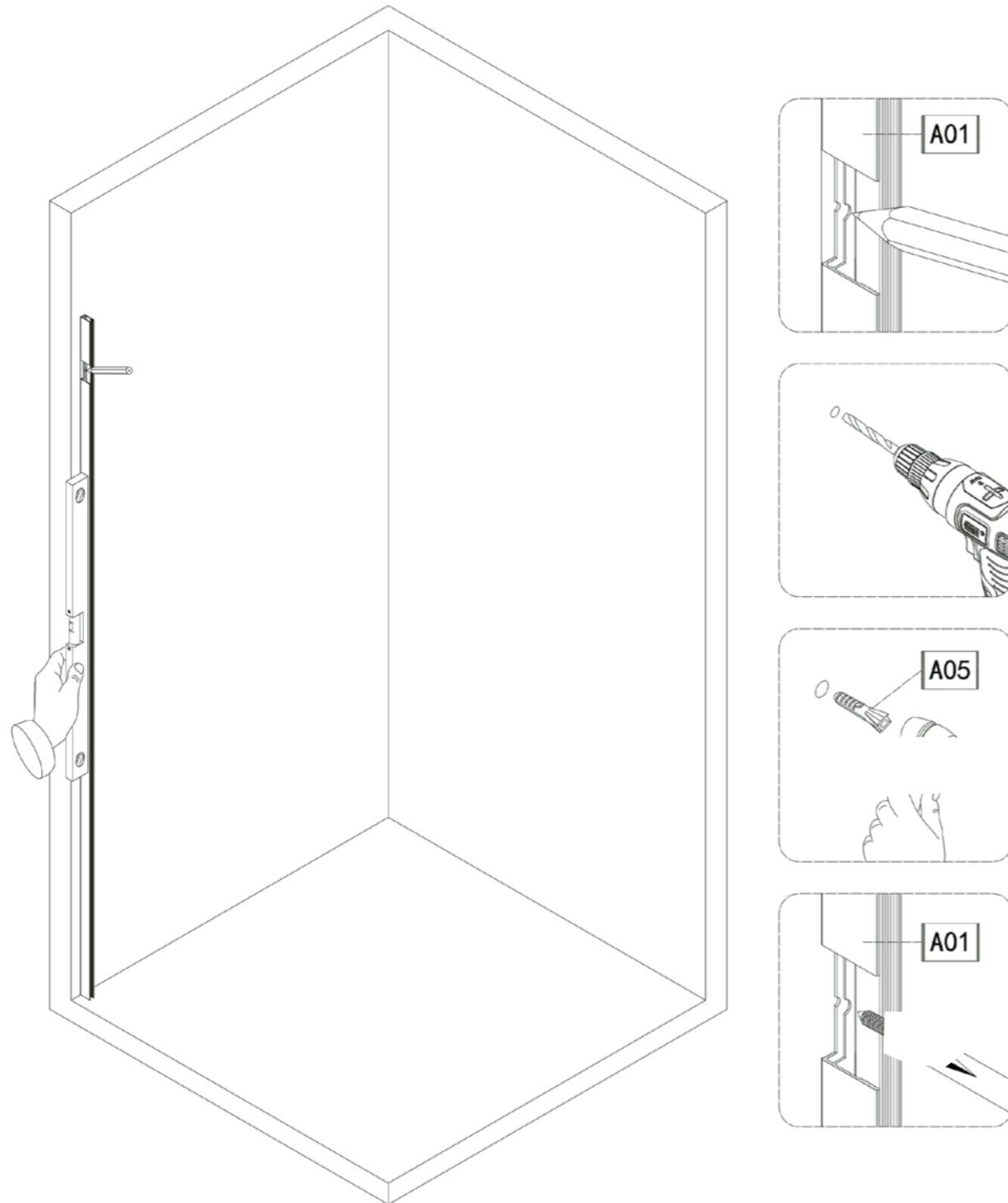

2

