

Mounted Cat Shelf Installation Instructions

Mounted Cat Shelf

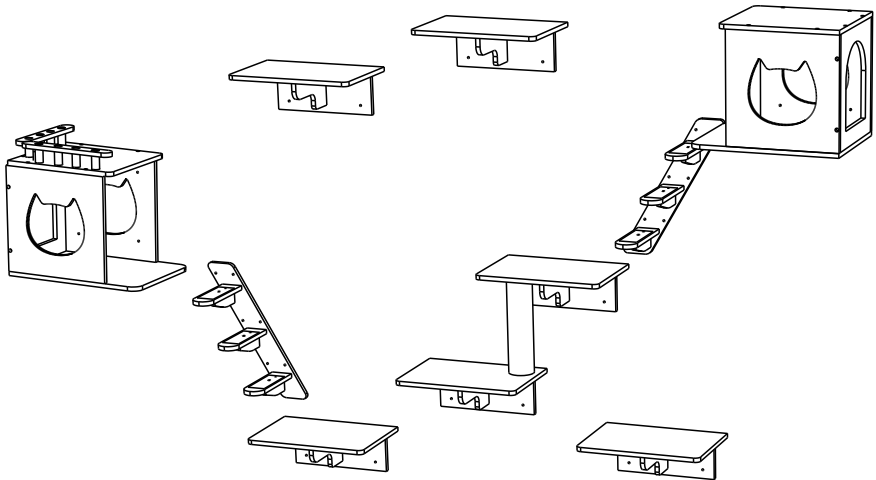

Model: SSGQK-05







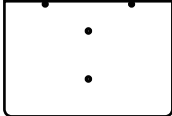
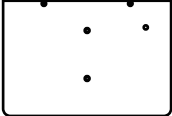
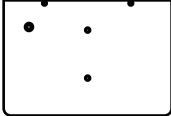
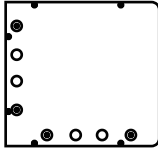
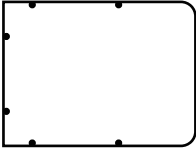
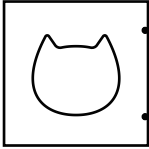
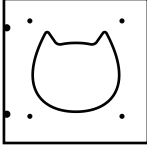
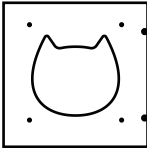
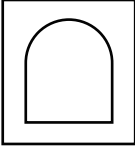
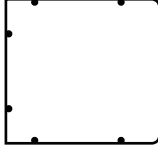





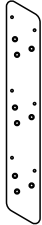
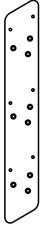
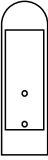

SPECIFICATIONS

Model	SSGQK-05
Color	Nature

COMPONENTS

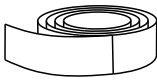
 <p>Ax4</p>	 <p>Bx1</p>	 <p>Cx1</p>
 <p>Dx1</p>	 <p>Ex2</p>	 <p>Fx2</p>
 <p>G1x1</p>	 <p>G2x1</p>	 <p>Hx2</p>
 <p>Ix1</p>	 <p>Jx6</p>	 <p>Kx2</p>
<p>* each set of products is equipped with screwdrivers and wrenches</p>		

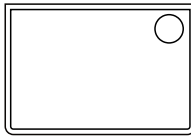
COMPONENTS

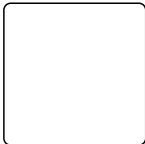
 <p>M1x1</p>	 <p>M2x1</p>	 <p>Ox6</p>
<p>(M8*35)</p>  <p>R1x2</p>	<p>(M4*70) (M6*40)</p>   <p>R2x52 R3x100</p>	  <p>O1x52 O2x52</p>
  <p>P1x1 P2x8</p>	 <p>Qx1</p>	 <p>Rx6</p>
<p>(Loop-pile mat)</p>  <p>Sx1</p>	<p>(Loop-pile mat)</p>  <p>Ux5</p>	<p>(Plain velours)</p>  <p>Tx3</p>
<p>* each set of products is equipped with screwdrivers and wrenches</p>		

Assembly Instructions

TIPS:

1. The number of screws marked above is the actual number used during installation. When the product is shipped, 1~3 more screws of each type will be given as spares.
2. During the use of the product, children are prohibited from approaching without the company of adults.
3. The edge of the product is a bit sharp, and you need to wear gloves for installation; at the same time, it comes with sandpaper, so you can polish the edge again by yourself; without gloves, be careful when touching the running wheel.
4. Do not tighten the installation screws at once. Tighten the installation screws twice after all screws are aligned
5. It is recommended that two or more people install the device



6. Please use the following tools to install



Tape measure



Scissors



Marker pen



screwdriver



Electric drill

Please mark the position on the wall against the plate, reserve about 30cm distance between the jump platforms, drill the hole and bury the expansion tube
(A 6mm drill bit is used for solid walls and a yellow expansion tube is embedded; a 9mm drill bit is used for hollow walls and a butterfly expansion tube is embedded)

Expansion solenoid



Butterfly solenoid



M4*70

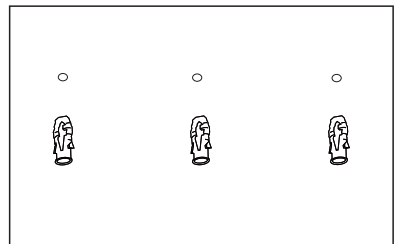

Assembly Instructions

STEP 1

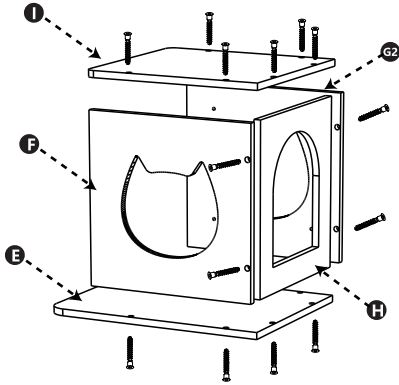

Install the cat's nest as shown

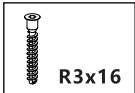

STEP 2

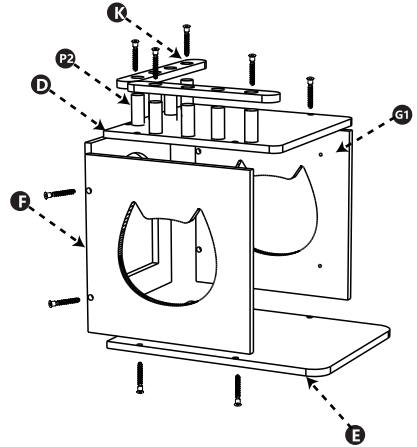

Install the cat's nest as shown

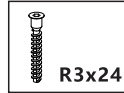

STEP 3

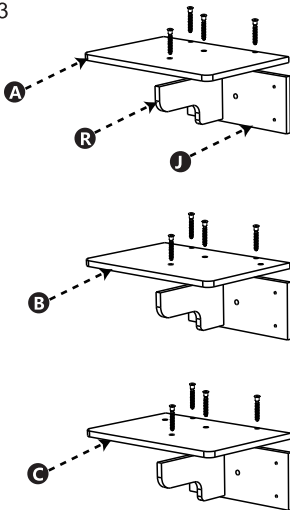

Mounting platform

STEP 4

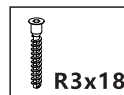
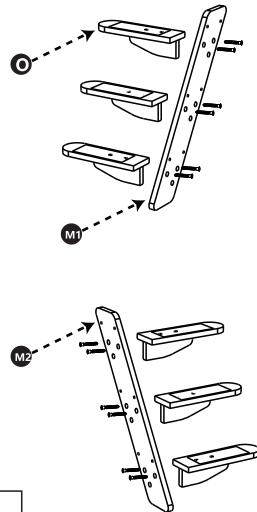

Mounting ladder

Assembly Instructions

STEP 5

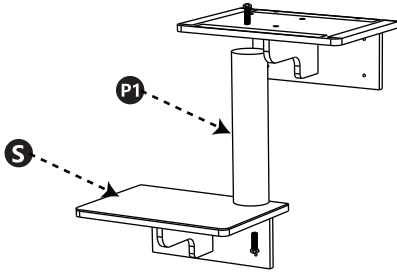

R1x2

Combined platform

STEP 6

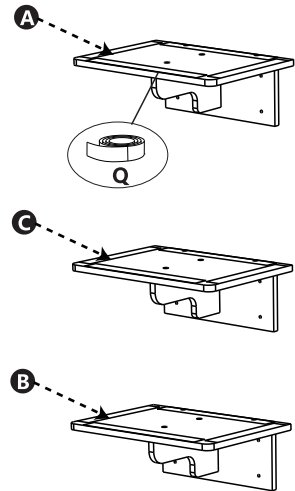

Backing glue

STEP 7

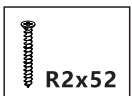
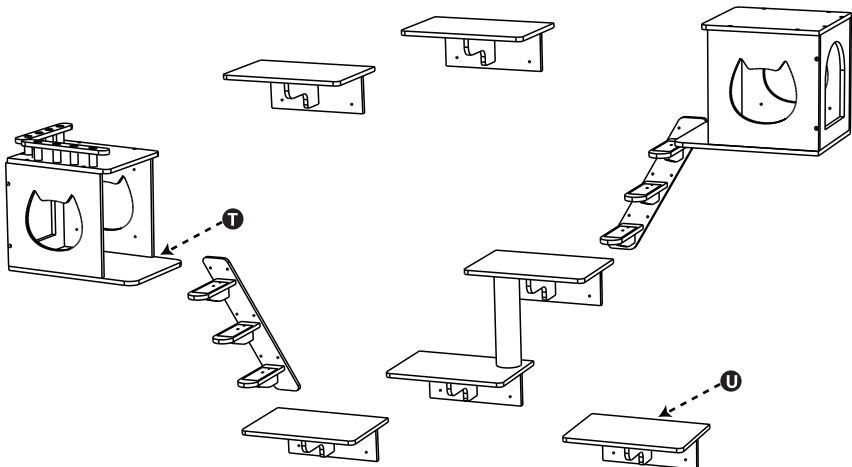

R2x52

All the parts are nailed to the wall, all the MATS are put in
(It is recommended that the installation distance between jumps be about 30cm)

Address: Shuangchenglu 803nong11hao1602A-1609shi, baoshanqu, shanghai 200000 CN.

Imported to AUS: SIHAO PTY LTD, 1 ROKEVA STREETEASTWOOD NSW 2122 Australia

Imported to USA: Sanven Technology Ltd.Suite 250, 9166 Anaheim Place, Rancho Cucamonga, CA 91730

EC	REP
-----------	------------

E-CrossStu GmbH.

Mainzer Landstr.69, 60329 Frankfurt am Main.

UK	REP
-----------	------------

YH CONSULTING LIMITED.

C/O YH Consulting Limited Office 147, Centurion House,
London Road, Staines-upon-Thames, Surrey, TW18 4AX.

Estante para gatos montado Ins talación
Instrucciones

Mounted Cat Shelf

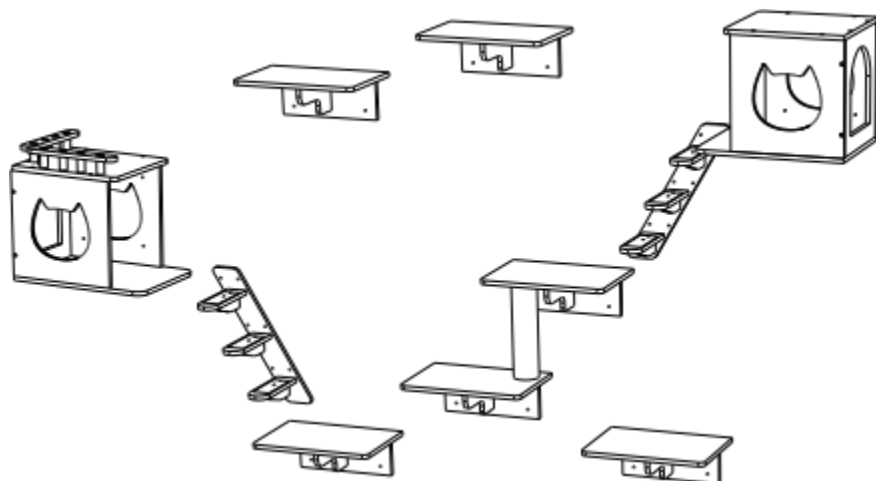

Modelo: SSGQK-05







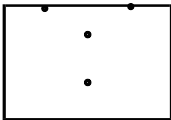
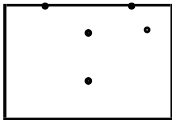
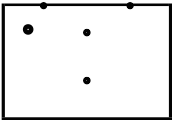
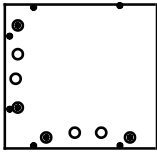
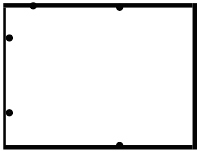
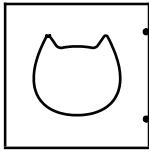
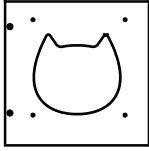
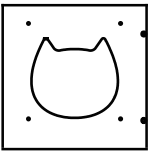
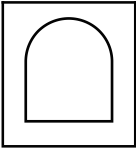
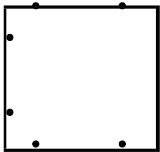
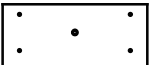









ESPECIFICACIONES

Modelo	SSGQK-05
Color	Naturaleza

COMPONENTES

 <p>hacha4</p>	 <p>caja 1</p>	 <p>Cx1</p>
 <p>Dx 1</p>	 <p>Ej . 2</p>	 <p>FX 2</p>
 <p>G1x1</p>	 <p>G2x1</p>	 <p>Hx 2</p>
 <p>Ix1</p>	 <p>Jx 6</p>	 <p>Kx 2</p>
<p>*cada conjunto de productos está equipado con destornilladores y llaves</p>		

COMPONENTS

 <p>M1x1</p>	 <p>M2x1</p>	 <p>O1x6</p>
<p>(M8*35)</p>  <p>R1x2</p>	<p>(M4*70) (M6*40)</p>   <p>R2x52 R3x100</p>	  <p>O1x52 O2x52</p>
  <p>P1x1 P2x8</p>	 <p>Qx1</p>	 <p>Rx6</p>
<p>(Loop-pile mat)</p>  <p>Sx1</p>	<p>(Loop-pile mat)</p>  <p>Ux5</p>	<p>(Plain velours)</p>  <p>Tx3</p>
<p>* each set of products is equipped with screwdrivers and wrenches</p>		

Asamblea Instrucciones

CONSEJOS :

1. El número de tornillos marcado arriba es el actual número usado durante instalación. cuando el producto se envía, 1 ~ 3 más tornillos de cada escriba voluntad ser dado como repuestos.
2. Durante el usar de el producto , niños son prohibido de que se acerca sin el compañía de adultos .
3. El borde del producto es a un poco agudo, y tú necesidad usar guantes para instalación; al mismo tiempo , viene con papel de lija, Vos tambien poder polaco el borde de nuevo por tí mismo; sin guantes , ser cuidadoso cuando conmovedor el correr rueda .
4. No apriete las cuadrillas de instalación. En seguida . Apriete el instalación tornillos dos veces después todos los tornillos están alineados
5. Se recomienda que dos o más la gente instala el dispositivo



6. utilice las siguientes herramientas para instalar



Cinta métrica tijeras Rotulador destornillador Taladro eléctrico

marque la posición en la pared contra la placa, reserve una distancia de aproximadamente 30 cm entre las plataformas de salto, taladre el agujero y enterrar la expansión tubo (Se utiliza una broca de A6 mm para paredes solidas y se incrusta un tubo de expansión amarillo ; a mmm perforar bit se utiliza para paredes huecas y un tubo de expansión de mariposa. incorporado)

Solenoide de expansión



Mariposa a solenoide



M4*70

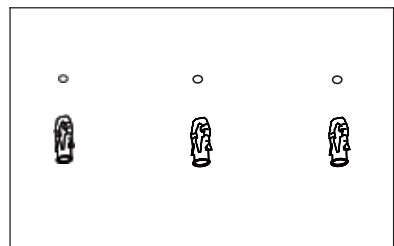

Assembly Instructions

STEP 1

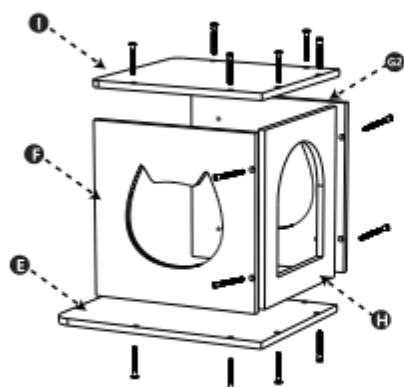

Install the cat's nest as shown



R3x16

STEP 2

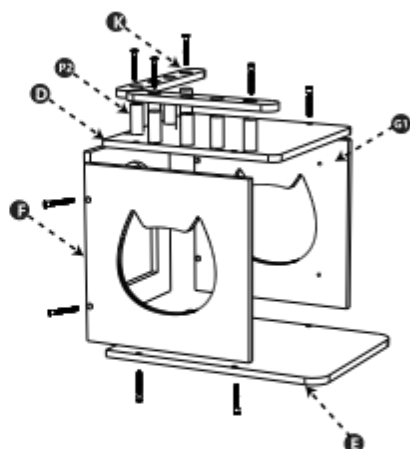

Install the cat's nest as shown

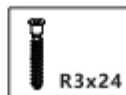

R3x24

STEP 3

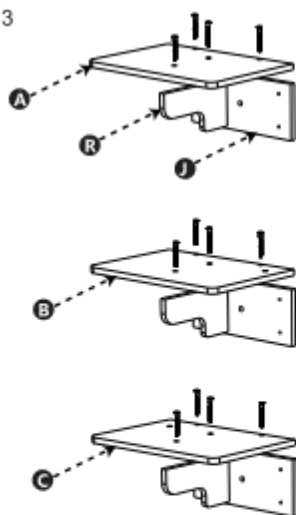

R3x30

Mounting platform

STEP 4

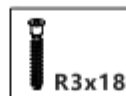
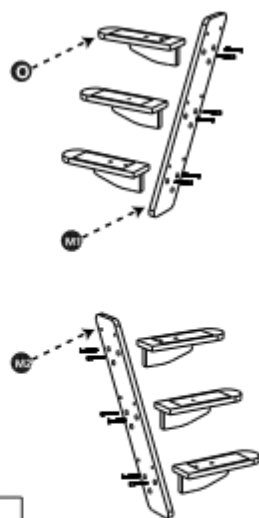

R3x18

Mounting ladder

Assembly Instructions

STEP 5

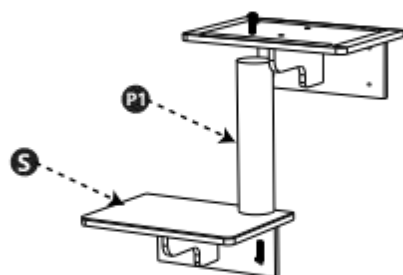

R1x2

Combined platform

STEP 6

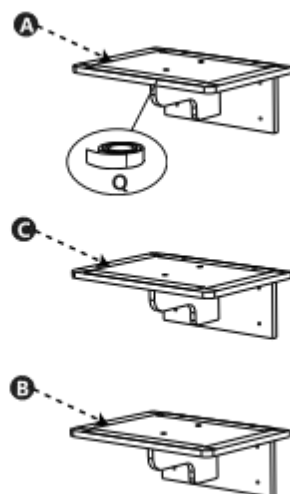

Backing glue

STEP 7

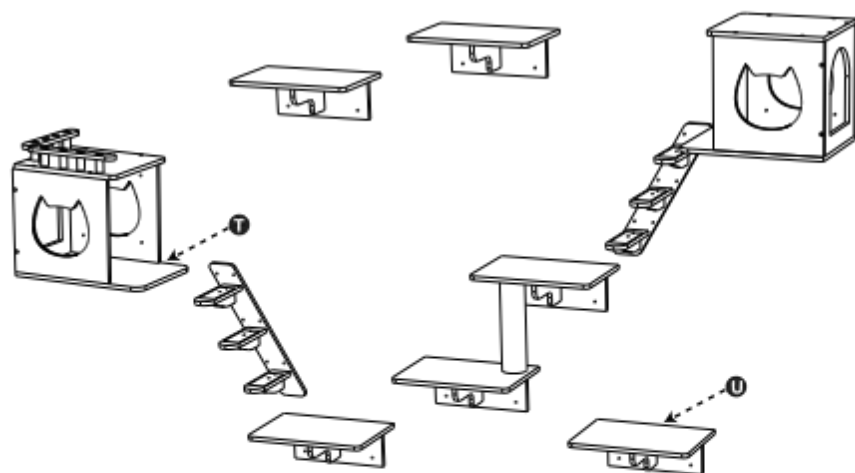

R2x52

All the parts are nailed to the wall, all the MATS are put in
(It is recommended that the installation distance between jumps be about 30cm)

Address: Shuangchenglu 803nong11hao1602A-1609shi, baoshanqu, shanghai 200000 CN.

Imported to AUS: SIHAO PTY LTD, 1 ROKEVA STREETEASTWOOD NSW 2122 Australia

Imported to USA: Sanven Technology Ltd.Suite 250, 9166 Anaheim Place, Rancho Cucamonga, CA 91730



E-CrossStu GmbH.

Mainzer Landstr.69, 60329 Frankfurt am Main.



YH CONSULTING LIMITED.

C/O YH Consulting Limited Office 147, Centurion House,
London Road, Staines-upon-Thames, Surrey, TW18 4AX.

Mensola per gatti montata Installazione Istruzioni

Mounted Cat Shelf

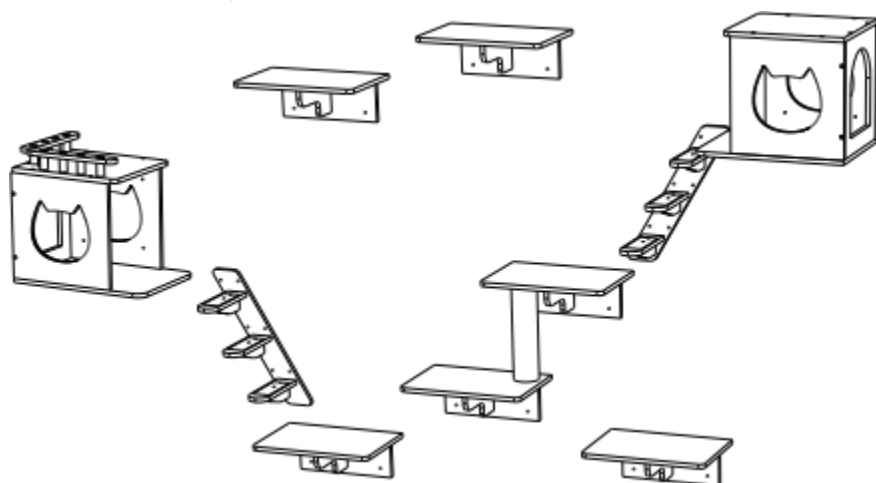

Modello: SSGQK-05







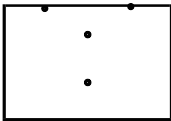
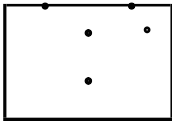
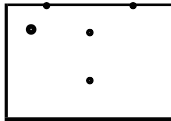
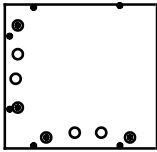
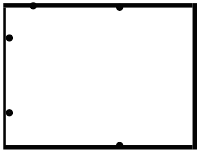
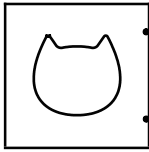
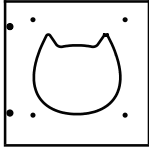
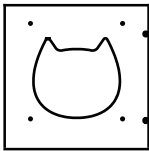
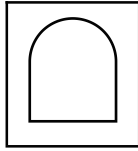
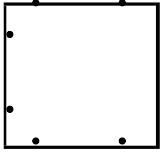
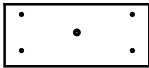









SPECIFICHE

Modello	SSGQK-05
Colore	Natura

COMPONENTI

 <p>Ascia4</p>	 <p>Bx1</p>	 <p>Cx1</p>
 <p>Dx1</p>	 <p>Es 2</p>	 <p>Fx2</p>
 <p>G1x1</p>	 <p>G2x1</p>	 <p>Hx2</p>
 <p>Ix1</p>	 <p>Jx 6</p>	 <p>Kx2</p>
<p>*ogni insieme di prodotti s è dotato di cacciaviti e chiavi inglesi</p>		

COMPONENTS

 <p>M1x1</p>	 <p>M2x1</p>	 <p>O1x6</p>
<p>(M8*35)</p>  <p>R1x2</p>	<p>(M4*70) (M6*40)</p>   <p>R2x52 R3x100</p>	  <p>O1x52 O2x52</p>
  <p>P1x1 P2x8</p>	 <p>Qx1</p>	 <p>Rx6</p>
<p>(Loop-pile mat)</p>  <p>Sx1</p>	<p>(Loop-pile mat)</p>  <p>Ux5</p>	<p>(Plain velours)</p>  <p>Tx3</p>
<p>* each set of products is equipped with screwdrivers and wrenches</p>		

Assemblea Istruzioni

SUGGERIMENTI :

- 1 .IL numero di viti segnato Sopra è il effettivo numero utilizzato durante installazione . Quando IL Prodotto viene spedito , 1 ~3 più viti di ciascun tipo volontà Essere dato COME pezzi di ricambio.
2. Durante IL utilizzo Di IL Prodotto , bambini Sono proibito da avvicinandosi senza il azienda Di adulti .
3. Il bordo del Prodotto È UN un po' tagliente, E tu Bisogno indossare i guanti per installazione; allo stesso tempo, viene fornito con carta vetrata, Quindi tu Potere polacco IL bordo Ancora da solo; senza guanti , Essere attento Quando toccante IL corsa ruota .
- 4 . Non stringere le viti dell'installazione subito . Stringere il installazione viti due volte dopo tutte le viti sono allineate
5. Si consiglia di due o Di più le persone lo installano dispositivo



- 6 . si prega di utilizzare i seguenti strumenti per l'installazione



Forbici per metro a nastro Cacciavite per pennarello Trapano elettrico

si prega di segnare la posizione sul muro contro la piastra, riservando una distanza di circa 30 cm fra le piattaforme di salto, praticare il foro sinistro e seppellire l' espansione tubo

(Per. viene utilizzata la punta da trapano A6mm pareti solide ed è incorporato un tubo di espansione giallo ; UN mmm trapano bit viene utilizzato per pareti cave e un tubo di espansione a farfalla incorporato)

Solenoid
di
espansio
ne



Farfalla
solenoid
e



M4*70

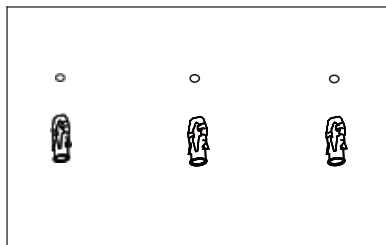

Assembly Instructions

STEP 1

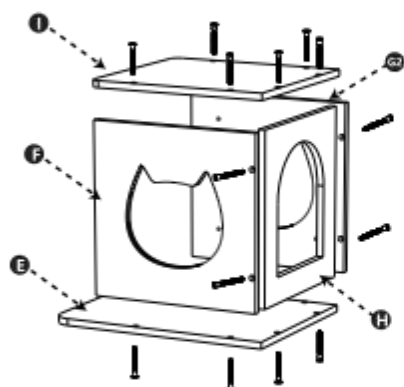

Install the cat's nest as shown



R3x16

STEP 2

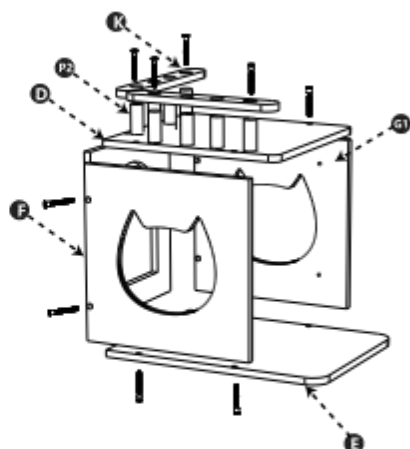

Install the cat's nest as shown

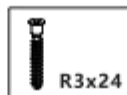

R3x24

STEP 3

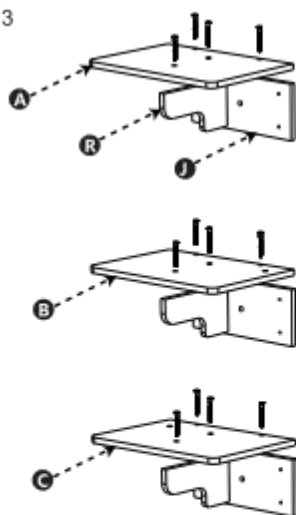

R3x30

Mounting platform

STEP 4

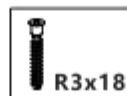
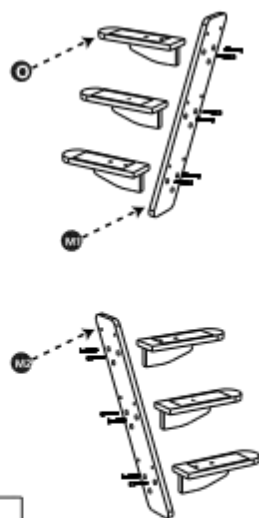

R3x18

Mounting ladder

Assembly Instructions

STEP 5

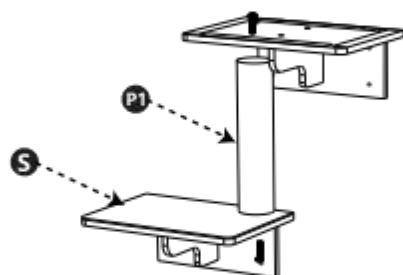

R1x2

Combined platform

STEP 6

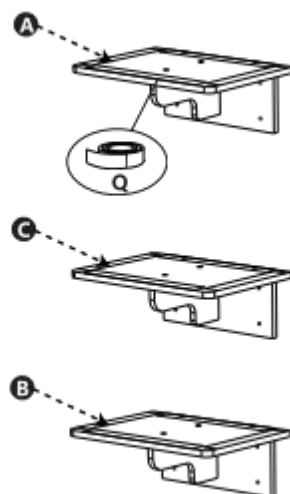

Backing glue

STEP 7

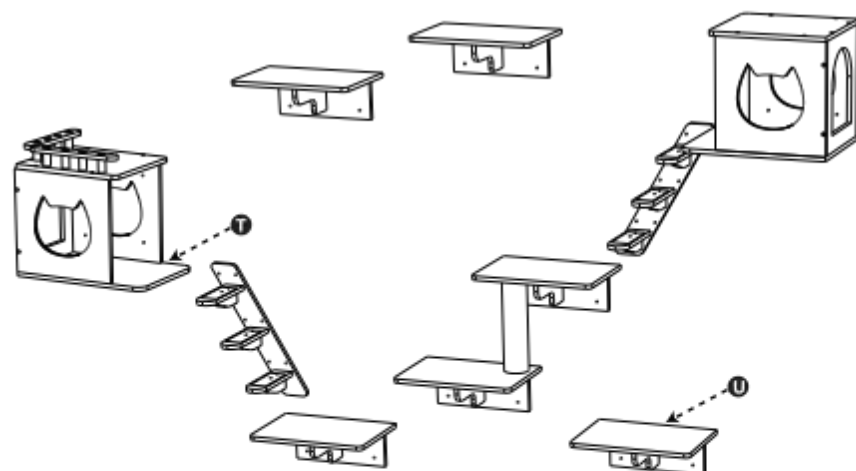

R2x52

All the parts are nailed to the wall, all the MATS are put in
(It is recommended that the installation distance between jumps be about 30cm)

Address: Shuangchenglu 803nong11hao1602A-1609shi, baoshanqu, shanghai 200000 CN.

Imported to AUS: SIHAO PTY LTD, 1 ROKEVA STREETEASTWOOD NSW 2122 Australia

Imported to USA: Sanven Technology Ltd.Suite 250, 9166 Anaheim Place, Rancho Cucamonga, CA 91730



E-CrossStu GmbH.

Mainzer Landstr.69, 60329 Frankfurt am Main.



YH CONSULTING LIMITED.

C/O YH Consulting Limited Office 147, Centurion House,
London Road, Staines-upon-Thames, Surrey, TW18 4AX.

Zamontowana półka dla kota Instalacja Instrukcje

Mounted Cat Shelf

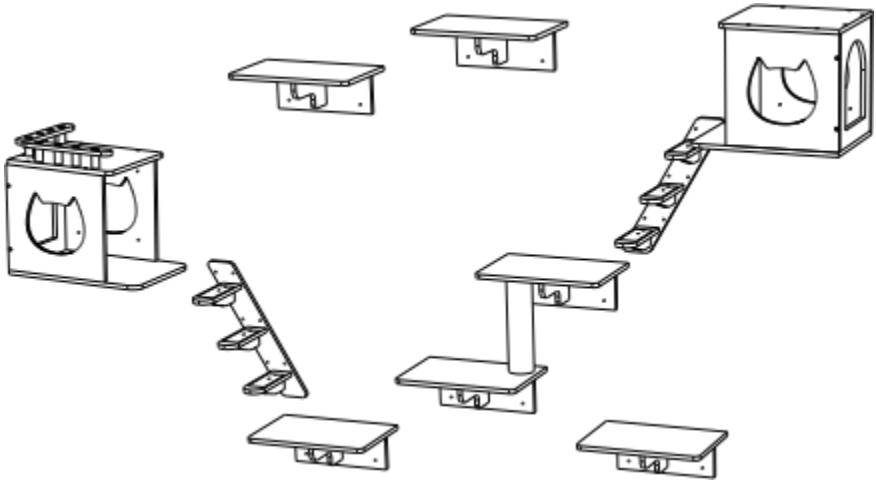

Model: SSGQK-05







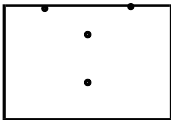
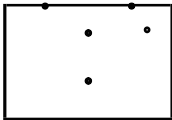
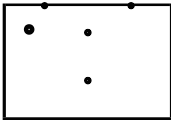
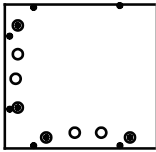
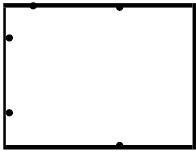
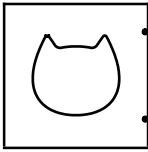
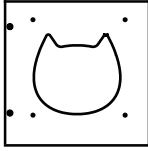
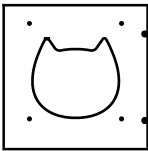
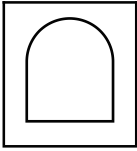
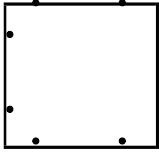
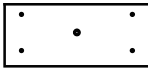









SPECYFIKACJE

Model	SSGQK-05
Kolor	Natura

SKŁADNIKI

 <p>Topór 4</p>	 <p>Bx1</p>	 <p>Cx1</p>
 <p>Dx 1</p>	 <p>Przykład 2</p>	 <p>Fx 2</p>
 <p>G1x1</p>	 <p>G2x1</p>	 <p>Hx2</p>
 <p>Ix1</p>	 <p>Jx 6</p>	 <p>Kx2</p>
<p>*każdy zestaw produktów s wyposażona jest w wkrętki i klucze</p>		

COMPONENTS

 <p>M1x1</p>	 <p>M2x1</p>	 <p>O1x6</p>
<p>(M8*35)</p>  <p>R1x2</p>	<p>(M4*70) (M6*40)</p>   <p>R2x52 R3x100</p>	  <p>O1x52 O2x52</p>
  <p>P1x1 P2x8</p>	 <p>Qx1</p>	 <p>Rx6</p>
<p>(Loop-pile mat)</p>  <p>Sx1</p>	<p>(Loop-pile mat)</p>  <p>Ux5</p>	<p>(Plain velours)</p>  <p>Tx3</p>
<p>* each set of products is equipped with screwdrivers and wrenches</p>		

Montaż Instrukcje

PORADY :

1. The liczba śrub wyraźny powyżej jest rzeczywisty użyty numer podczas instalacja . Kiedy the produkt jest wysyłany , 1 ~ 3 więcej śrub każdego wpisz wołę Być dany Jak części zamienne.
 2. Podczas the używać z the produkt , dzieci Czy zabroniony z zbliżający się bez firma z dorośli ludzie .
 3. Krawędź z produkt Jest A trochę ostry, A ty potrzebować nosić rękawiczki Do instalacja; w tym samym czasie , to przychodzi z papier ścierny, Więc ty Móc polski the krawędź
- Ponownie sam; bez rękawiczek , Być ostrożny Kiedy wzruszające the działanie koło . 4 . Nie dokręcać ekip montażowych natychmiast . Dokręcić instalacja później dwukrotnie wkręcić wszystkie śruby są wyrównane
5. Zaleca się , aby dwa lub więcej ludzie to instalują urządzenie



- 6 . Do instalacji użyj następujących narzędzi



Nożyczki miernicze Marker Śrubokręt Wiertarka elektryczna

proszę zaznaczyć pozycję na ścianie względem płyty, zachowując odległość około 30 cm między platformy do skoków, wywierć otwór i pogrzebać ekspansję rura (Wiertło A6mm służy do solidne ściany i osadzona jest żółta rurka rozprężna ; A gmm wiertarka bit jest używany pustych ścian i motylkowej rurki rozprężnej osadzony)

Elektroza
wór
rozprężn
y



Motyl
Elektroz
awór



M4*70

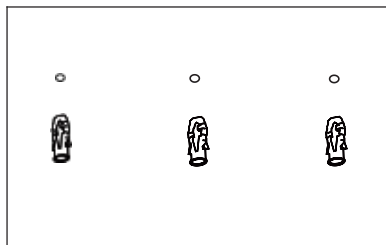

Assembly Instructions

STEP 1

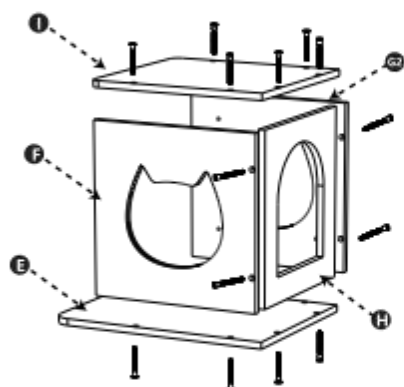

Install the cat's nest as shown



R3x16

STEP 2

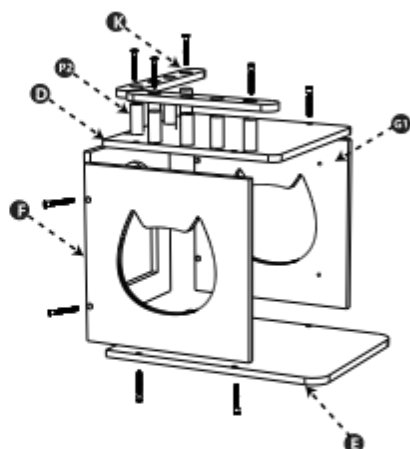

Install the cat's nest as shown

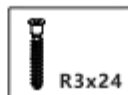

R3x24

STEP 3

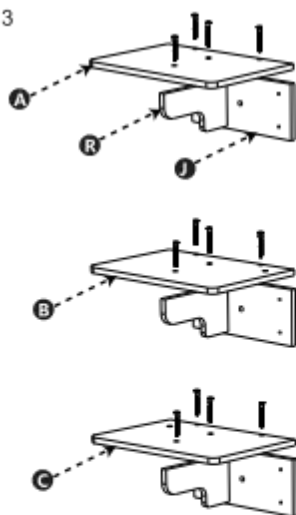

Mounting platform



R3x30

STEP 4

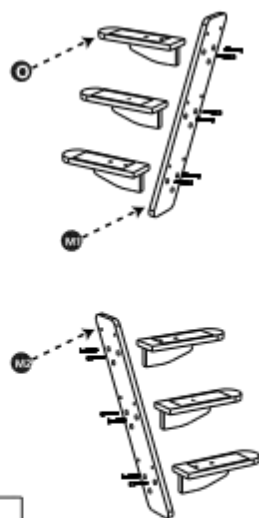

Mounting ladder

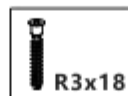

R3x18

Assembly Instructions

STEP 5

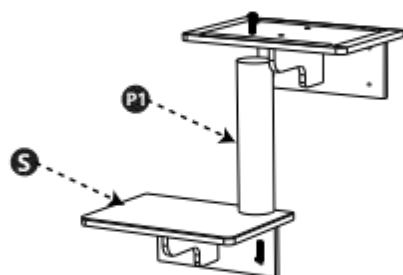

R1x2

Combined platform

STEP 6

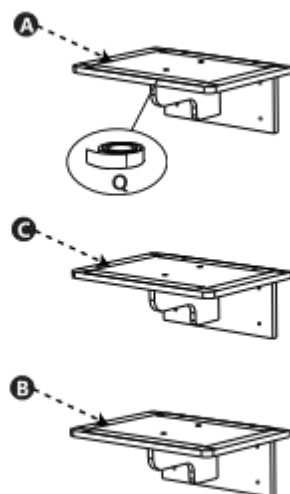

Backing glue

STEP 7

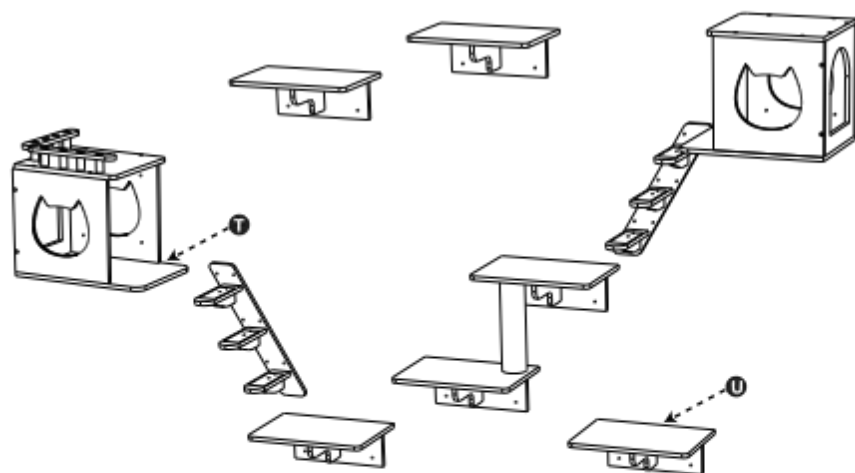

R2x52

All the parts are nailed to the wall, all the MATS are put in
(It is recommended that the installation distance between jumps be about 30cm)

Address: Shuangchenglu 803nong11hao1602A-1609shi, baoshanqu, shanghai 200000 CN.

Imported to AUS: SIHAO PTY LTD, 1 ROKEVA STREETEASTWOOD NSW 2122 Australia

Imported to USA: Sanven Technology Ltd.Suite 250, 9166 Anaheim Place, Rancho Cucamonga, CA 91730



E-CrossStu GmbH.

Mainzer Landstr.69, 60329 Frankfurt am Main.



YH CONSULTING LIMITED.

C/O YH Consulting Limited Office 147, Centurion House,
London Road, Staines-upon-Thames, Surrey, TW18 4AX.

Montiertes Katzenregal Installation Anweisungen

Mounted Cat Shelf

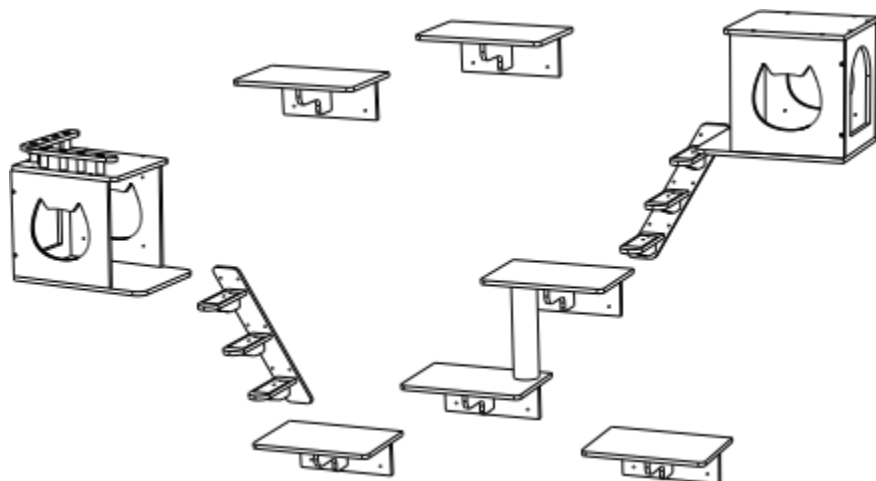

Modell: SSGQK-05







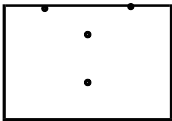
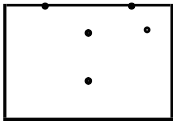
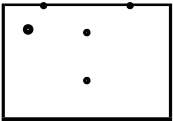
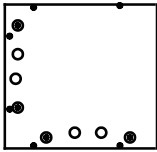
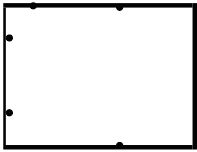
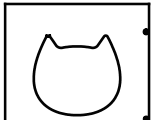
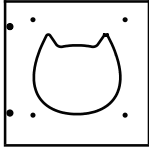
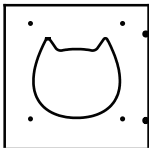
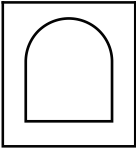
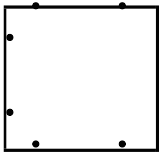
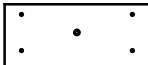









SPEZIFIKATIONEN

Modell	SSGQK-05
Farbe	Natur

KOMPONENTEN

 <p>Ax4</p>	 <p>Bx1</p>	 <p>Cx1</p>
 <p>Dx1</p>	 <p>Beispiel 2</p>	 <p>Effekt 2</p>
 <p>G1x1</p>	 <p>G2x1</p>	 <p>Hx2</p>
 <p>Ix1</p>	 <p>Jx6</p>	 <p>Kx2</p>
<p>*jede Satz von Produkten ist ausgestattet mit Schraubendreher und Schraubenschlüssel</p>		

COMPONENTS

 <p>M1x1</p>	 <p>M2x1</p>	 <p>O1x6</p>
<p>(M8*35)</p>  <p>R1x2</p>	<p>(M4*70) (M6*40)</p>   <p>R2x52 R3x100</p>	  <p>O1x52 O2x52</p>
  <p>P1x1 P2x8</p>	 <p>Qx1</p>	 <p>Rx6</p>
<p>(Loop-pile mat)</p>  <p>Sx1</p>	<p>(Loop-pile mat)</p>  <p>Ux5</p>	<p>(Plain velours)</p>  <p>Tx3</p>
<p>* each set of products is equipped with screwdrivers and wrenches</p>		

Montage Anweisungen

TIPPS :

1 .Der Anzahl Schrauben markiert über ist der tatsächlich verwendete Nummer während

Installation . Wann Die Produkt Wird versandt , 1 ~3 mehr Schrauben von jedem Typ wird Sei gegeben als Ersatzteile.

2. Während Die verwenden von Die Produkt , Kinder Sind verboten aus nähert sich ohne das Unternehmen von Erwachsene .

3. Die Kante des Produkt Ist A etwas scharf, Und du brauchen Handschuhe tragen für

Installation; gleichzeitig , Es kommt mit Sandpapier, Also du dürfen Polieren Die Rand wieder alleine; ohne Handschuhe , Sei vorsichtig Wann berührend Die läuft

Rad . 4 . Ziehen SiedieMontageschrauben nicht fest auf einmal . Ziehen Sie die Installation

Schrauben zweimal nach alle Schrauben sind ausgerichtet

5. Es wird empfohlen, zwei oder mehr Leute installieren t er Gerät



6 . Bitte verwenden Sie zur Installation die folgenden Tools



Maßband Schere Markierstift Schraubendreher Bohrmaschine

Bitte markieren Sie die Position an der Wand gegenüber der Platte und lassen Sie ca. 30 cm Abstand . zwischen die Sprungplattformen, bohren Sie ein Loch und begraben die Erweiterung Rohr

(Ein 6mm Bohrer wird verwendet für Massivwände und ein gelbes Expansionsrohr ist eingebettet; ein 6mm Bohrer wird verwendet für Hohlwände und ein Butterfly-Expansionsrohr ist eingebettet)

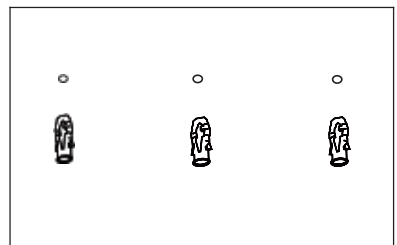

Expansion
smagnet



Schmett
erling
Magnet



M4*70



Assembly Instructions

STEP 1

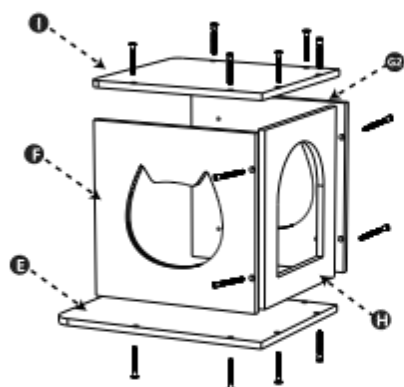

Install the cat's nest as shown



STEP 2

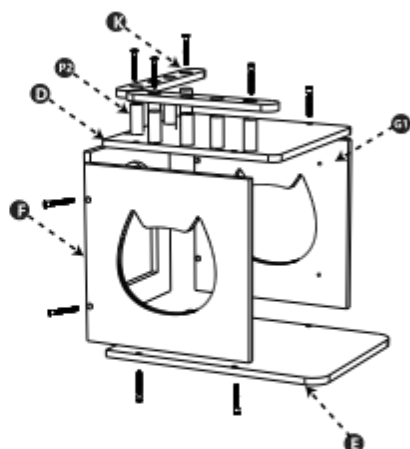

Install the cat's nest as shown

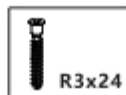

STEP 3

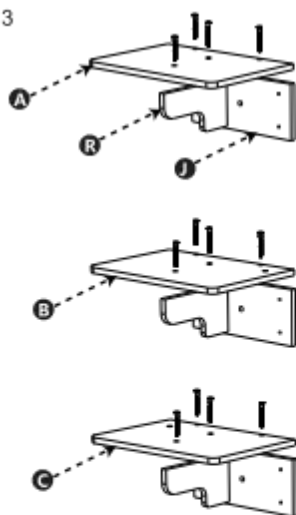

Mounting platform

STEP 4

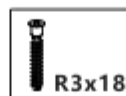
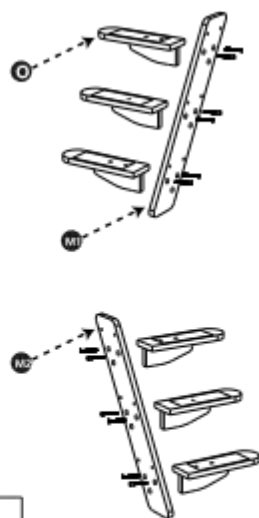

Mounting ladder

Assembly Instructions

STEP 5

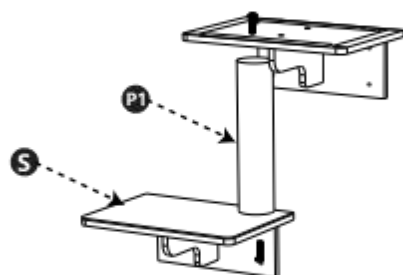

R1x2

Combined platform

STEP 6

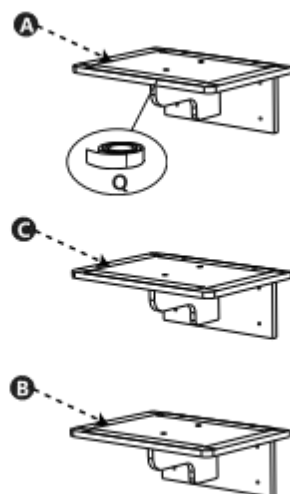

Backing glue

STEP 7

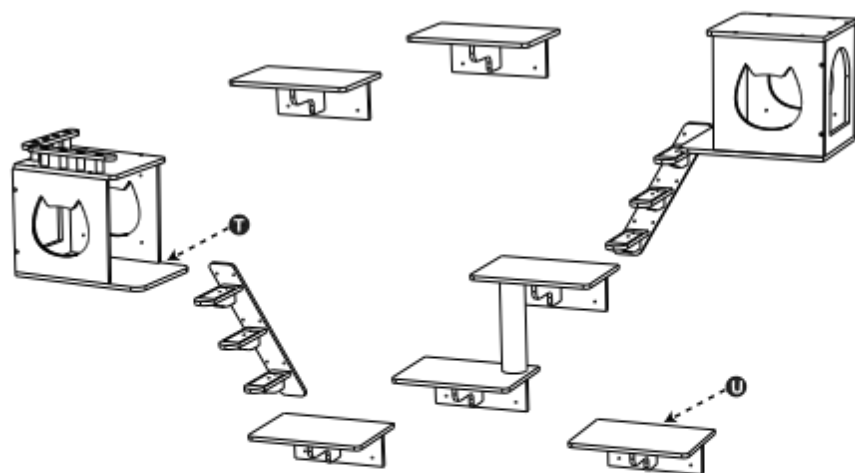

R2x52

All the parts are nailed to the wall, all the MATS are put in
(It is recommended that the installation distance between jumps be about 30cm)

Address: Shuangchenglu 803nong11hao1602A-1609shi, baoshanqu, shanghai 200000 CN.

Imported to AUS: SIHAO PTY LTD, 1 ROKEVA STREETEASTWOOD NSW 2122 Australia

Imported to USA: Sanven Technology Ltd.Suite 250, 9166 Anaheim Place, Rancho Cucamonga, CA 91730



E-CrossStu GmbH.

Mainzer Landstr.69, 60329 Frankfurt am Main.



YH CONSULTING LIMITED.

C/O YH Consulting Limited Office 147, Centurion House,
London Road, Staines-upon-Thames, Surrey, TW18 4AX.

Étagère pour chat montée Installation Instructions

Mounted Cat Shelf

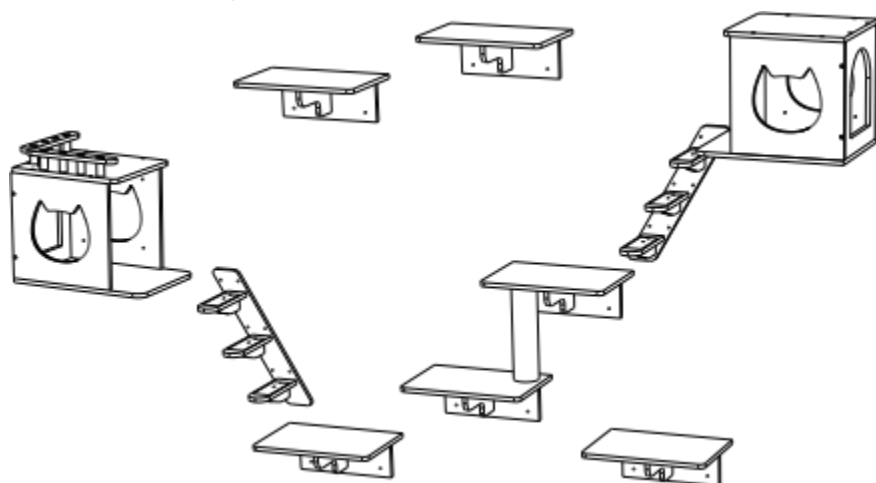

Modèle : SSGQK-05







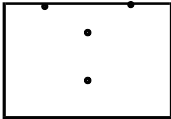
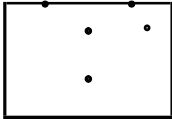
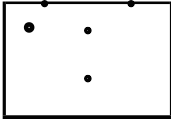
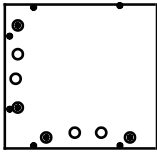
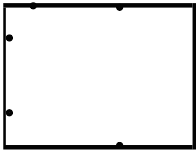
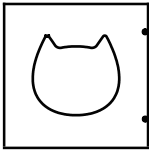
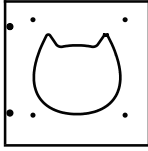
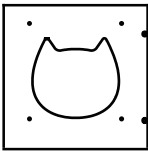
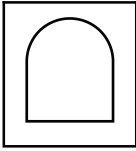
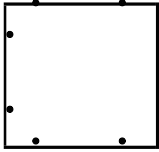
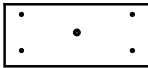









CARACTÉRISTIQUES

Modèle	SSGQK-05
Couleur	Nature

COMPOSANTS

 <p>Axe4</p>	 <p>Boîte 1</p>	 <p>Cx1</p>
 <p>Dx1</p>	 <p>Ex 2</p>	 <p>Effet 2</p>
 <p>G1x1</p>	 <p>G2x1</p>	 <p>Hx2</p>
 <p>Ix1</p>	 <p>Jx6</p>	 <p>Kx2</p>
<p>*chaque ensemble de produits est équipé de tournevis et de clés</p>		

COMPONENTS

 <p>M1x1</p>	 <p>M2x1</p>	 <p>O1x6</p>
<p>(M8*35)</p>  <p>R1x2</p>	<p>(M4*70) (M6*40)</p>   <p>R2x52 R3x100</p>	  <p>O1x52 O2x52</p>
  <p>P1x1 P2x8</p>	 <p>Qx1</p>	 <p>Rx6</p>
<p>(Loop-pile mat)</p>  <p>Sx1</p>	<p>(Loop-pile mat)</p>  <p>Ux5</p>	<p>(Plain velours)</p>  <p>Tx3</p>
<p>* each set of products is equipped with screwdrivers and wrenches</p>		

Assemblée Instructions

CONSEILS :

- 1 .Le nombre de vis marqué au-dessus de est le réel numéro utilisé pendant installation . quand le produit est expédié , 1 ~3 plus de vis de chaque tapez va être donné comme pièces de rechange.
2. Pendant le utiliser de le produit , enfants sont interdit depuis approchant sans le entreprise de adultes .
3. Le bord de la produit est un un peu pointu, et toi besoin porter des gants pour installation; en même temps , Il est livré avec papier de verre, Alors toi peut polonais le bord encore par toi-même; sans gants , être prudent quand émouvant le en cours d'exécution roue .
4. NE PAS serrer les équipes de l'installation immédiatement . Serrez le installation visser deux fois après toutes les vis sont alignées
5. Il est recommandé que deux ou plus les gens l' installent appareil



- 6 . veuillez utiliser les outils suivants pour installer



Ciseaux à ruban à mesurer Stylo marqueur Tournevis Perceuse électrique

veuillez marquer la position sur le mur contre la plaque, réserver une distance d'environ 30 cm entre les plates-formes de saut, percer le trou droit et enterrer l' expansion tube (Un foret de 6 mm est utilisé pour murs solides et un tube d'expansion jaune est intégré ; un gmm percer le bit est utilisé pour des parois creuses et un tube d'expansion papillon sont intégré)

Solénoïde
d'expansi
on

Papillon
solénoï
de

M4*70

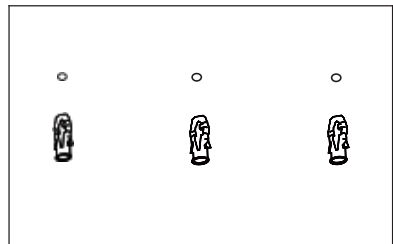

Assembly Instructions

STEP 1

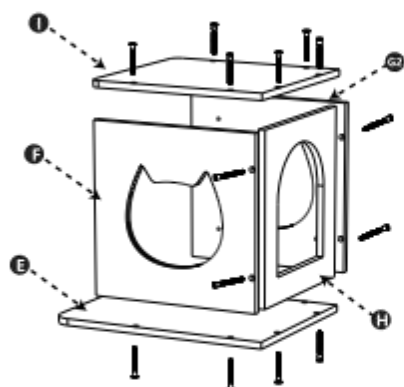

Install the cat's nest as shown



STEP 2

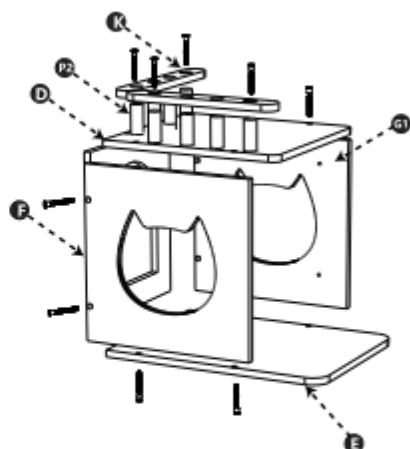

Install the cat's nest as shown



STEP 3

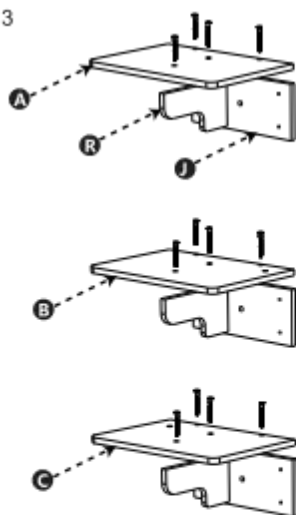

Mounting platform

STEP 4

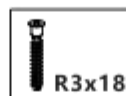
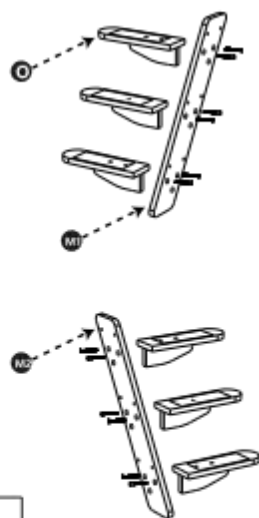

Mounting ladder

Assembly Instructions

STEP 5

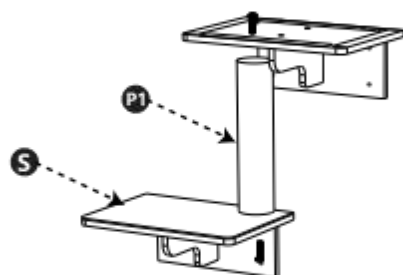

R1x2

Combined platform

STEP 6

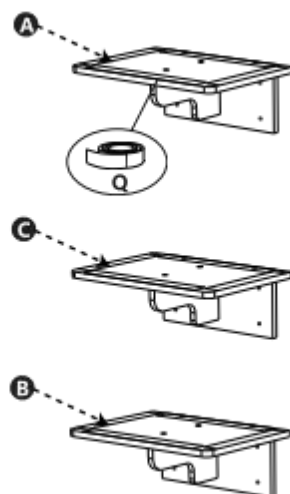

Backing glue

STEP 7

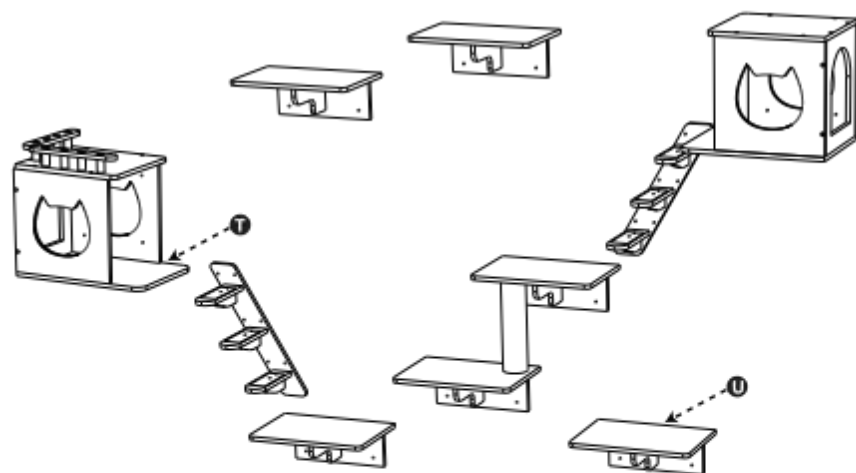

R2x52

All the parts are nailed to the wall, all the MATS are put in
(It is recommended that the installation distance between jumps be about 30cm)

Address: Shuangchenglu 803nong11hao1602A-1609shi, baoshanqu, shanghai 200000 CN.

Imported to AUS: SIHAO PTY LTD, 1 ROKEVA STREETEASTWOOD NSW 2122 Australia

Imported to USA: Sanven Technology Ltd.Suite 250, 9166 Anaheim Place, Rancho Cucamonga, CA 91730



E-CrossStu GmbH.

Mainzer Landstr.69, 60329 Frankfurt am Main.



YH CONSULTING LIMITED.

C/O YH Consulting Limited Office 147, Centurion House,
London Road, Staines-upon-Thames, Surrey, TW18 4AX.

Gemonteerde kattenplank Ins tallatie Instructies

Mounted Cat Shelf

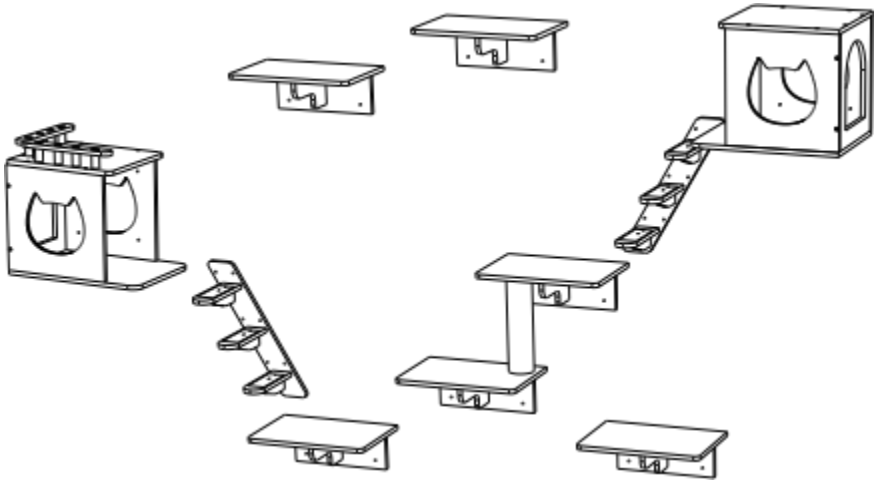

Model: SSGQK-05







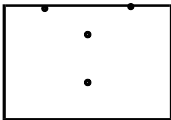
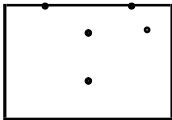
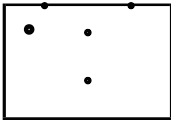
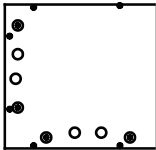
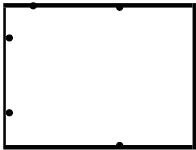
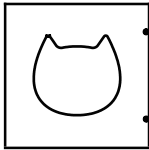
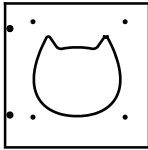
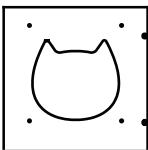
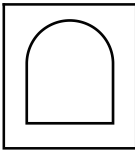
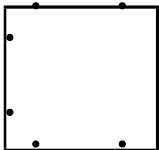
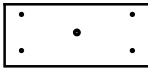









SPECIFICATIES

Model	SSGQK-05
Kleur	Natuur

COMPONENTEN

 <p>Bijl4</p>	 <p>Bx 1</p>	 <p>Cx1</p>
 <p>Dx 1</p>	 <p>Ex 2</p>	 <p>Fx 2</p>
 <p>G1x1</p>	 <p>G2x1</p>	 <p>Hx 2</p>
 <p>Ix1</p>	 <p>Jx 6</p>	 <p>Kx 2</p>
<p>*elk set producten is uitgerust met schroevendraaiers en sleutels</p>		

COMPONENTS

 <p>M1x1</p>	 <p>M2x1</p>	 <p>O1x6</p>
<p>(M8*35)</p>  <p>R1x2</p>	<p>(M4*70) (M6*40)</p>   <p>R2x52 R3x100</p>	  <p>O1x52 O2x52</p>
  <p>P1x1 P2x8</p>	 <p>Qx1</p>	 <p>Rx6</p>
<p>(Loop-pile mat)</p>  <p>Sx1</p>	<p>(Loop-pile mat)</p>  <p>Ux5</p>	<p>(Plain velours)</p>  <p>Tx3</p>
<p>* each set of products is equipped with screwdrivers and wrenches</p>		

Montage Instructies

TIPS :

1. De aantal schroeven gemarkeerd boven is de feitelijk nummer gebruikt tijdens installatie . wanneer de Product wordt verzonden , 1 ~3 meer schroeven van elke typ wil zijn gegeven als reserveonderdelen.

2. Tijdens de gebruik van de Product , kinderen Zijn verboden van nadert zonder de bedrijf van volwassenen .

3. De rand van de Product is A beetje scherp, jij ook behoefte handschoenen te dragen voor

installatie; tegelijkertijd , het komt met schuurpapier, Dus jij kan Pools de rand

opnieuw alleen; zonder handschoenen , zijn voorzichtig wanneer ontroerend de

rennen wiel . 4 . Zorg ervoor dat het installatiepersoneel niet te strak zit

onmiddelijk . Draai de installatie

twee keer daarna schroeven alle schroeven zijn uitgelijnd

5. Het wordt aanbevolen om twee of meer mensen installeren hem apparaat



6 . Gebruik de volgende hulpmiddelen om te installeren



Meetlintschaar Markeerstiftschroevendraaier Elektrische boormachine

markeer de positie op de muur tegen de plaat, reserveer een afstand van ongeveer 30 cm tussen de springplatforms, boor het gat en begraaf de uitbreiding buis

(Er wordt een boor van 6 mm gebruikt stevige muren en er is een gele expansiebuis ingebed; A gmm oefening bitje wordt gebruikt holle wanden en een vlinderexpansiebuis ingebed)

Uitbreidin
gssoleno
ide

Vlinder
solenoï
de

M4*70

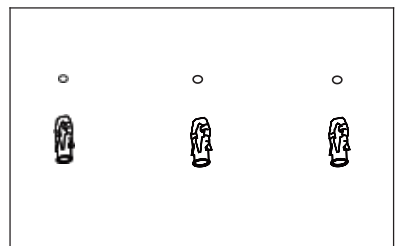

Assembly Instructions

STEP 1

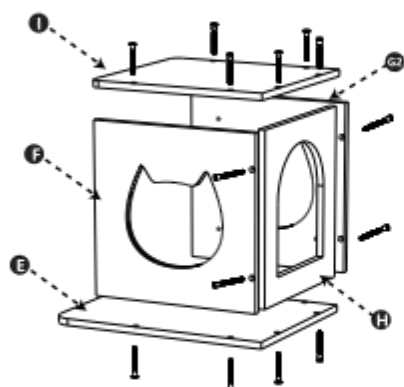

Install the cat's nest as shown



R3x16

STEP 2

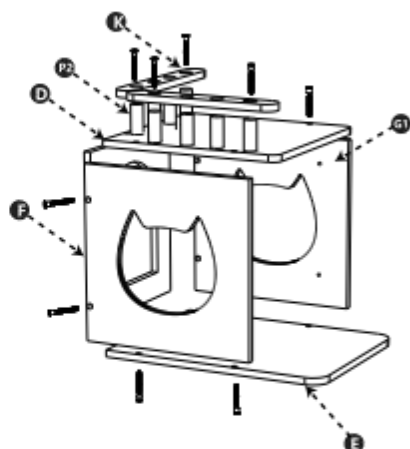

Install the cat's nest as shown

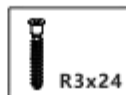

R3x24

STEP 3

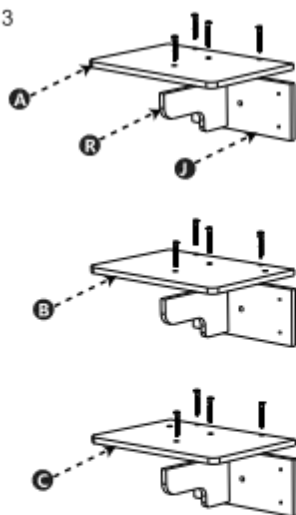

R3x30

Mounting platform

STEP 4

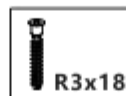
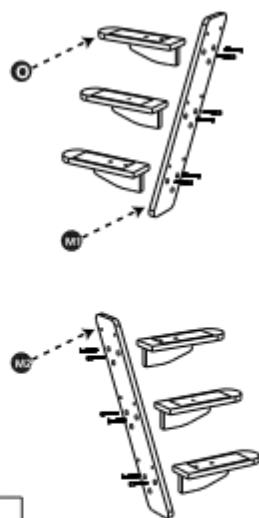

R3x18

Mounting ladder

Assembly Instructions

STEP 5

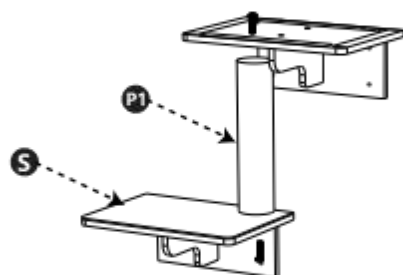

R1x2

Combined platform

STEP 6

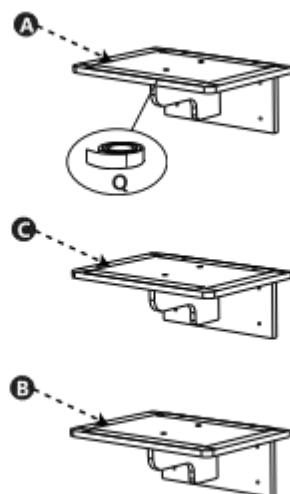

Backing glue

STEP 7

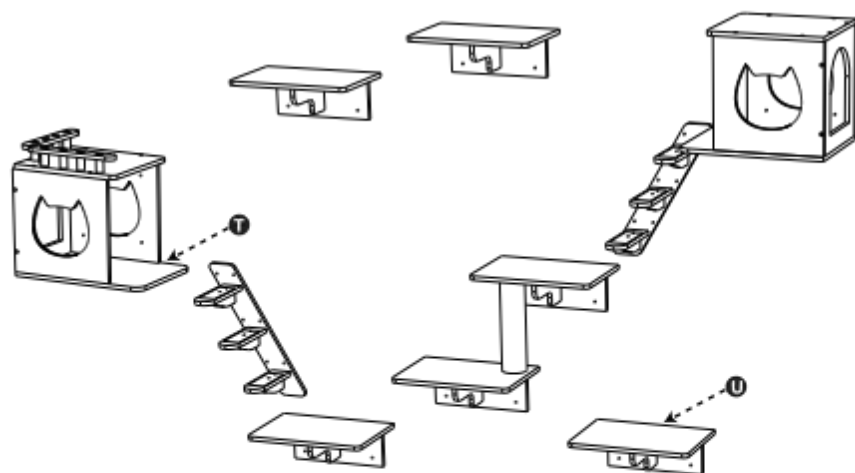

R2x52

All the parts are nailed to the wall, all the MATS are put in
(It is recommended that the installation distance between jumps be about 30cm)

Address: Shuangchenglu 803nong11hao1602A-1609shi, baoshanqu, shanghai 200000 CN.

Imported to AUS: SIHAO PTY LTD, 1 ROKEVA STREETEASTWOOD NSW 2122 Australia

Imported to USA: Sanven Technology Ltd.Suite 250, 9166 Anaheim Place, Rancho Cucamonga, CA 91730



E-CrossStu GmbH.

Mainzer Landstr.69, 60329 Frankfurt am Main.



YH CONSULTING LIMITED.

C/O YH Consulting Limited Office 147, Centurion House,
London Road, Staines-upon-Thames, Surrey, TW18 4AX.

Monterad kathylla Installation Instruktioner

Mounted Cat Shelf

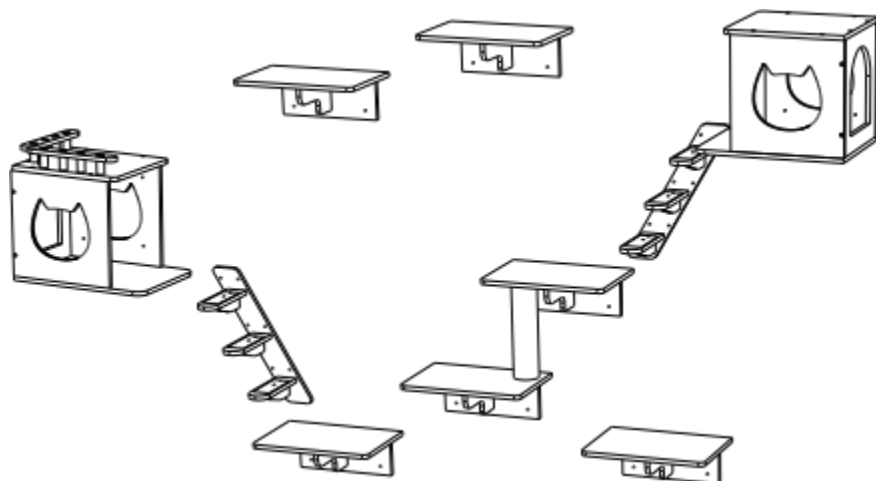

Modell: SSGQK-05







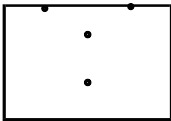
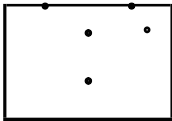
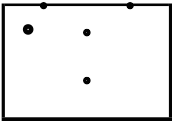
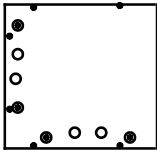
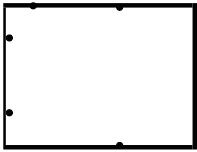
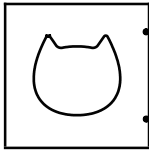
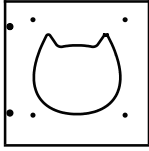
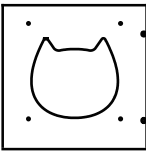
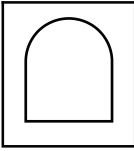
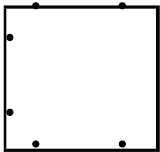
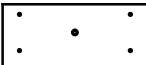









SPECIFIKATIONER

Modell	SSGQK-05
Färg	Natur

KOMPONENTER

 <p>Ax4</p>	 <p>Bx1</p>	 <p>Cx1</p>
 <p>Dx1</p>	 <p>Ex2</p>	 <p>Fx2</p>
 <p>G1x1</p>	 <p>G2x1</p>	 <p>Hx2</p>
 <p>Ix1</p>	 <p>Jx6</p>	 <p>Kx2</p>
<p>*varje uppsättning produkt s är utrustad med skruvmejslar och skiftnycklar</p>		

COMPONENTS

 <p>M1x1</p>	 <p>M2x1</p>	 <p>O1x6</p>
<p>(M8*35)</p>  <p>R1x2</p>	<p>(M4*70) (M6*40)</p>   <p>R2x52 R3x100</p>	  <p>O1x52 O2x52</p>
  <p>P1x1 P2x8</p>	 <p>Qx1</p>	 <p>Rx6</p>
<p>(Loop-pile mat)</p>  <p>Sx1</p>	<p>(Loop-pile mat)</p>  <p>Ux5</p>	<p>(Plain velours)</p>  <p>Tx3</p>
<p>* each set of products is equipped with screwdrivers and wrenches</p>		

hopsättning Instruktioner

TIPS :

- 1 .De antal skruvar markant ovan är faktisk nummer som används under installation . när de produkt skickas , 1 ~ 3 fler skruvar av varje typ kommer vara given som reservdelar.
2. Under de använda sig av av de produkt , barn är förbjuden från närmar sig utan företag av vuxna .
3. Kanten av produkt är a lite skarp, och du behöver att bära handskar för installation; på samma gång , det följer med sandpaper, Så du burk putsa de kant igen på egen hand; utan handskar , vara försiktig när rörande de löpning hjul .
- 4 . Dra inte åt installationens besättninga genast . Dra åt installation skruvar två gånger efter alla skruvar är inriktade
5. Det rekommenderas att två eller Mer folk installerar t han enhet



6 . använd följande verktyg för att installera



Måttbandssax Markörskruvmejsel Elektrisk borr

markera positionen på väggen mot plattan, reservera ca 30 cm avstånd mellan hoppplattformarna, borra hålet och begrava expansionen rör (A6 mm borr används för solida väggar och ett gult expansionsrör är inbäddat; a gmm borra bit används för ihåliga väggar och ett fjärrilsexpansionsrör är inbäddad)

Expansion
ssolenoi
d



Fjärril
solenoid



M4*70

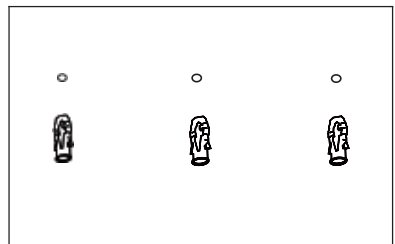

Assembly Instructions

STEP 1

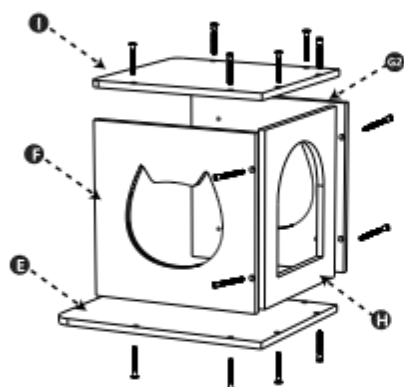

Install the cat's nest as shown



STEP 2

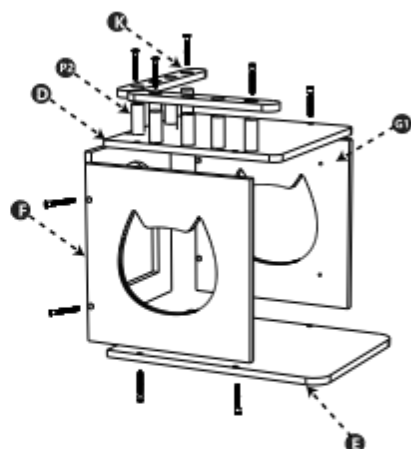

Install the cat's nest as shown



STEP 3

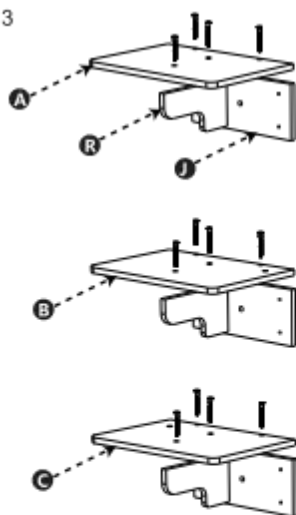

Mounting platform

STEP 4

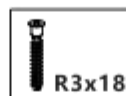
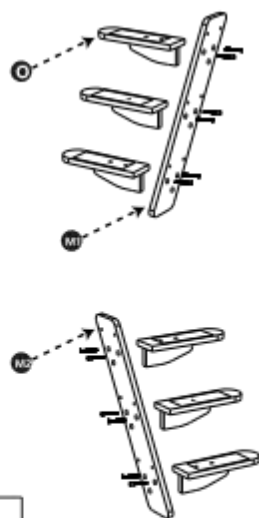

Mounting ladder

Assembly Instructions

STEP 5

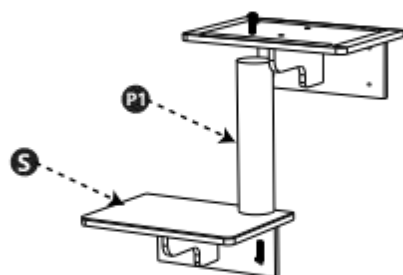

R1x2

Combined platform

STEP 6

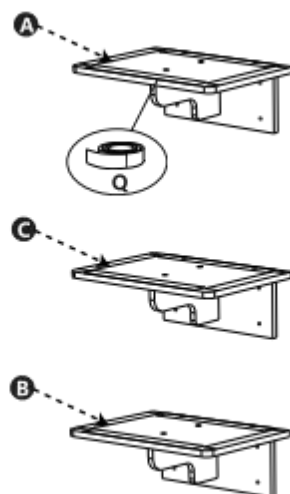

Backing glue

STEP 7

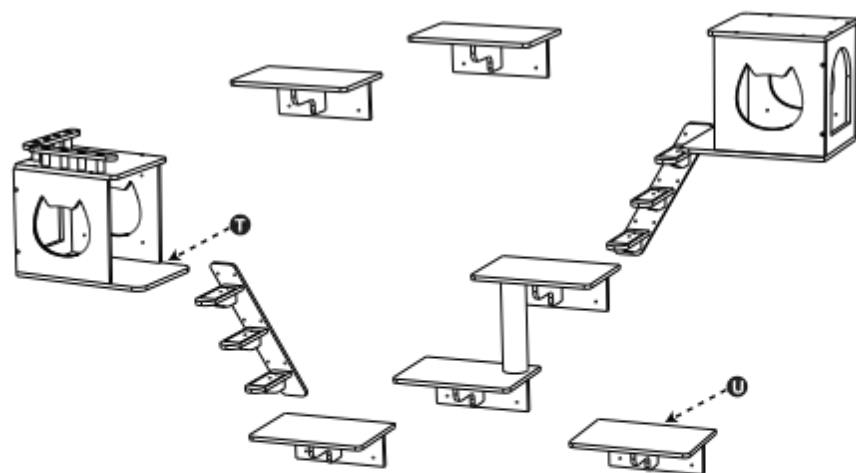

R2x52

All the parts are nailed to the wall, all the MATS are put in
(It is recommended that the installation distance between jumps be about 30cm)

Address: Shuangchenglu 803nong11hao1602A-1609shi, baoshanqu, shanghai 200000 CN.

Imported to AUS: SIHAO PTY LTD, 1 ROKEVA STREETEASTWOOD NSW 2122 Australia

Imported to USA: Sanven Technology Ltd.Suite 250, 9166 Anaheim Place, Rancho Cucamonga, CA 91730



E-CrossStu GmbH.

Mainzer Landstr.69, 60329 Frankfurt am Main.



YH CONSULTING LIMITED.

C/O YH Consulting Limited Office 147, Centurion House,
London Road, Staines-upon-Thames, Surrey, TW18 4AX.

