

# **FABRIC ROOM DIVIDE**

## **USER MANUAL**

**PFTSTGHS04**

**PFTSTGSH05**

**PFTSTGMS06**

# FABRIC ROOM DIVIDE

PFTSTGHS04 PFTSTGSH05 PFTSTGMS06

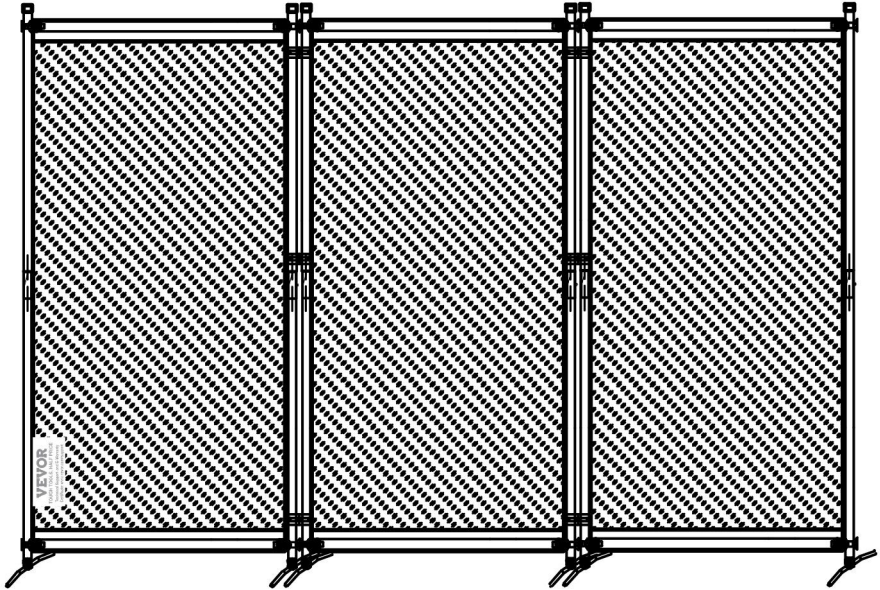

## SAFETY INSTRUCTIONS

### **WARNING:**

**Read this material before using this product. Failure to do so can result in serious injury.**

### **Assembly precautions**









1. Assemble only according to these instructions. Improper assembly can create hazards.
2. Wear ANSI-approved safety goggles and heavy-duty work gloves during assembly.
3. Keep the assembly area clean and well-lit.
4. Keep bystanders out of the area during assembly.
5. Do not assemble if tired or when under the influence of alcohol, drugs or medication.
6. The product capabilities apply to properly and completely assembled products only.
7. Assemble on a flat, level, hard and smooth surface capable of safely supporting the Fabric Room Divide.
8. For additional information regarding the parts listed in the following pages, please refer to the Assembly Diagram of this manual. Unwrap and separate all parts in a clean work area.

### **Use precautions**

1. DO NOT SIT OR STAND ON THIS ITEM.
2. This product is not a toy. Do not allow children to play with or near this item.
3. Do not exceed specified weight capacities.
4. Use only on a flat, level, hard, and smooth surface that can safely support a fully loaded Fabric Room Divide.
5. Use as intended only.
6. Inspect before every use; do not use if parts are loose or damaged.

**SAVE THIS MANUAL**

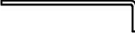
## PARTS LIST

A		6
B		6
C		6
D		6
E		6
F		2
G		1
H		3
I	 X18	Preloaded

**NOTE: F accessories are spare screws for gift; H is the fabric of the screen, pay attention not to get dirty when installing.**

## ASSEMBLY STEP

### STEP 1

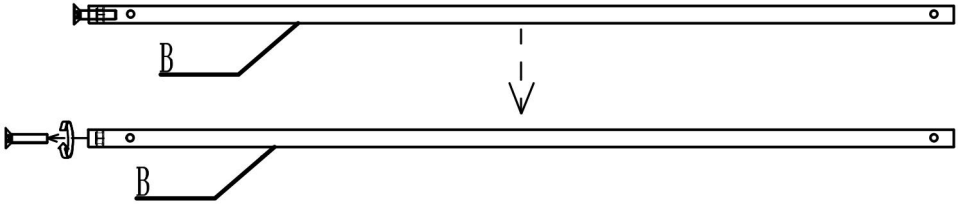

Unscrew from material B and set aside.

# X6

### STEP 2

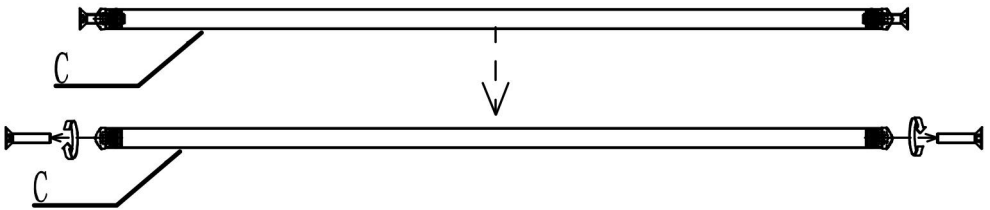

Unscrew from material C and set aside.

# X6

### STEP 3

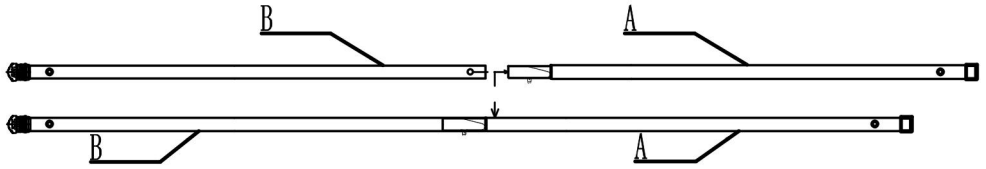

Connect material B and Material A (as shown in the figure) and put them together.

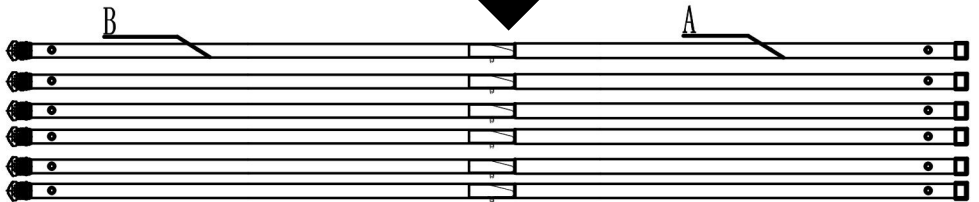

**Total 6 groups**

### STEP 4

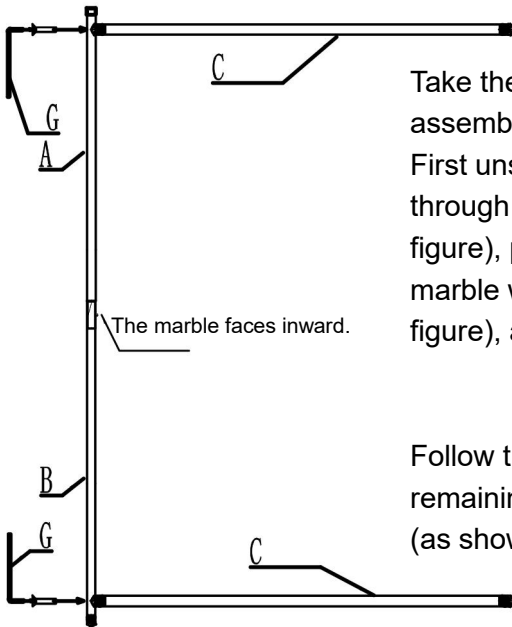

Take the two poles from Step 2 and assemble them on one pole from Step 3. First unscrew the screw, and then connect through the screw (as shown in the figure), pay attention to the position of the marble when combining (as shown in the figure), and then tighten with G tool.

Follow the same steps to connect the remaining 2 groups for a total of 3 groups (as shown)

## STEP 5



H Material is screen fabric, pay attention to keep clean during installation

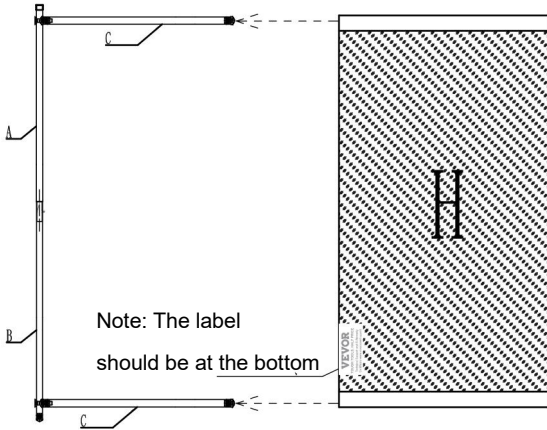

Insert the sleeve of material H into the upper and lower cross bars.

## STEP 6

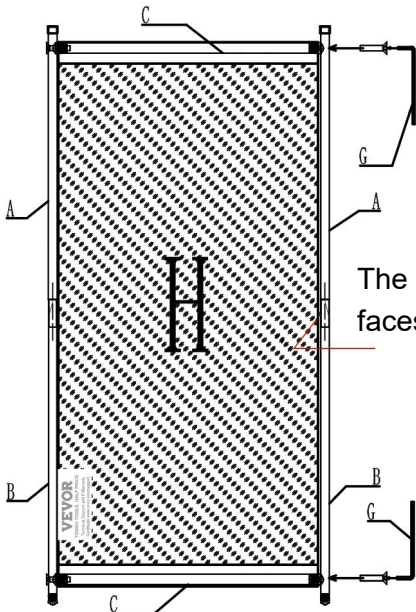

The marble faces inward.

From the remaining tubes in step 3, take a set of tubes, assemble them on the frame, unscrew the screws first, then connect them, and then tighten them with the G tool.

Do the same for the other two groups. Note the position of the marble.

## STEP 7

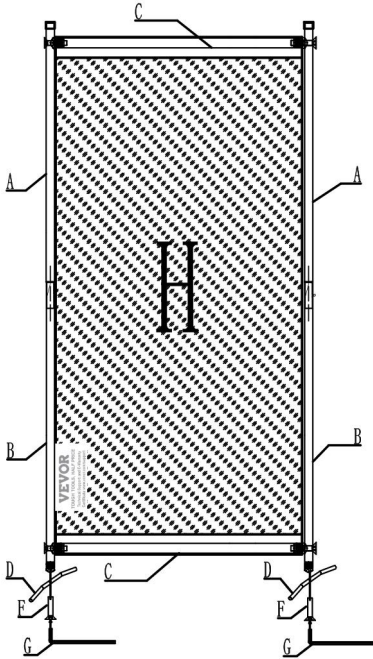

Take material D and assemble it in the frame of step 6. Unscrew the screw first, then connect it, and then tighten it with tool G.

The remaining 2 groups complete the assembly with the same steps.

## STEP 8

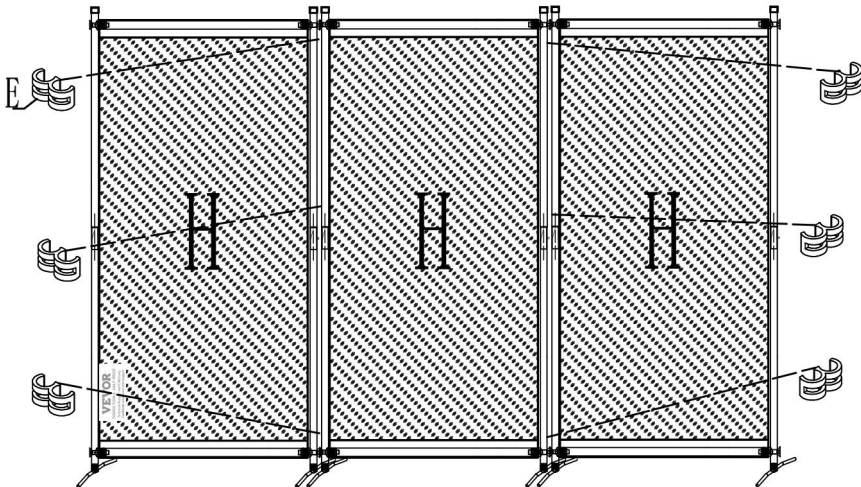

Put the 3 groups of shelves neatly and connect them by material B.

## STEP 9

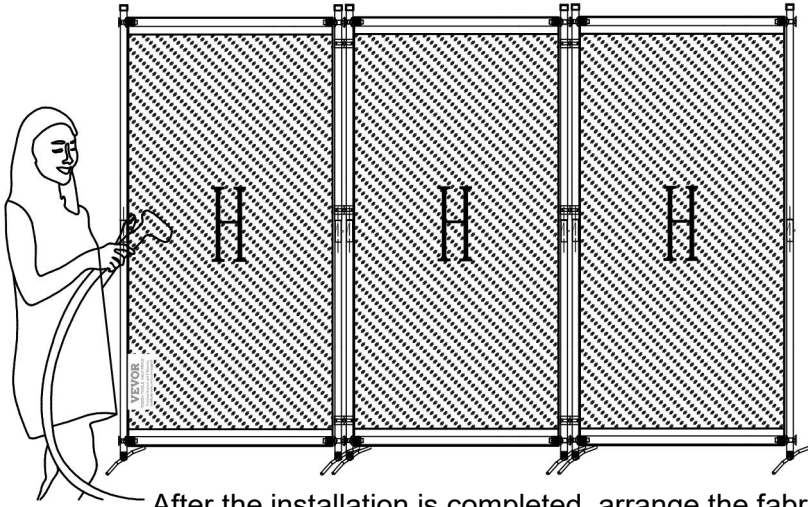

After the installation is completed, arrange the fabric to ensure that the fabric is smooth. If the fabric has wrinkles, you can use a household hanging press to iron it.

## STEP 10

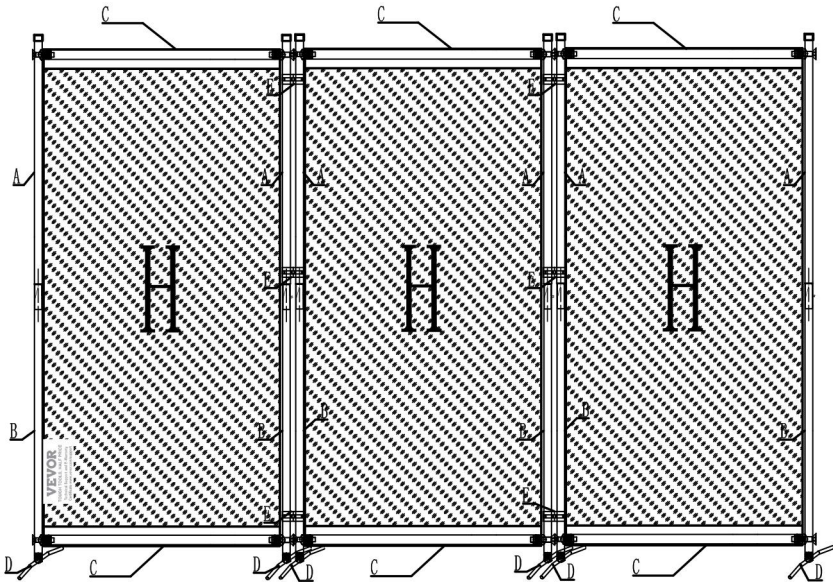

## PRODUCT PARAMETER

<b>Model</b>	<b>PFTSTGHS04</b>	<b>PFTSTGSH05</b>	<b>PFTSTGMS06</b>
<b>Colour</b>	Black	Gray	Cream-Coloured
<b>Number of panels</b>	3		
<b>Product Size</b>	2600*1840*520mm		

**Manufacturer:** Shanghaimuxinmuyeyouxiangongsi

**Address:** Shuangchenglu 803nong11hao1602A-1609shi, baoshanqu, shanghai 200000 CN.

**Imported to AUS:** SIHAO PTY LTD. 1 ROKEVA STREETEASTWOOD NSW 2122 Australia

**Imported to USA:** Sanven Technology Ltd. Suite 250, 9166 Anaheim Place, Rancho Cucamonga, CA 91730

<b>UK</b>	<b>REP</b>
-----------	------------

YH CONSULTING LIMITED. C/O YH Consulting Limited Office 147, Centurion House, London Road, Staines-upon-Thames, Surrey, TW18 4AX

<b>EC</b>	<b>REP</b>
-----------	------------

E-CrossStu GmbH  
Mainzer Landstr.69,  
60329 Frankfurt am Main.



# **CLOISON DE SÉPARATION EN TISSU**

## **MANUEL D' utilisation**

**PFTSTGHS04**

**PFTSTGSH05**

**PFTSTGMS06**



# FABRIC ROOM DIVIDE

PFTSTGHS04 PFTSTGSH05 PFTSTGMS06

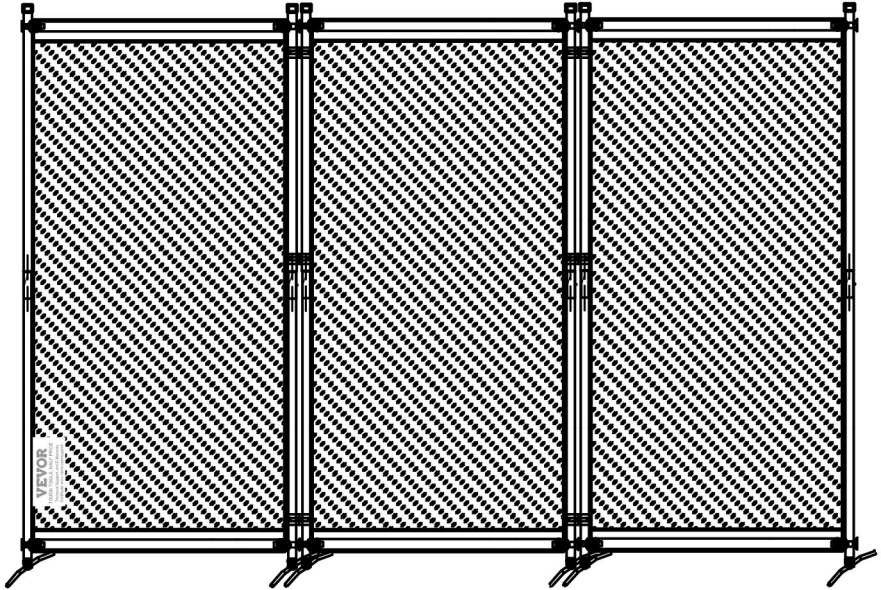



## SAFETY INSTRUCTIONS

### **AVERTISSEMENT:**

**Lisez ce document avant d'utiliser ce produit. Le non-respect de ces instructions peut entraîner des blessures graves.**

### **Précautions de montage**

9. Assembler uniquement selon ces instructions. Un assemblage incorrect peut créer des dangers.
10. Portez des lunettes de sécurité approuvées ANSI et des gants de travail robustes pendant l'assemblage.
11. Gardez la zone de montage propre et bien éclairée.
12. Gardez les spectateurs hors de la zone pendant le montage.
13. Ne pas monter si vous êtes fatigué ou sous l'influence de l'alcool, de drogues ou de médicaments.
14. Les capacités du produit s'appliquent uniquement aux produits correctement et entièrement assemblés.
15. Assemblez-le sur une surface plane, de niveau, dure et lisse capable de supporter en toute sécurité le séparateur de pièce en tissu.
16. Pour plus d'informations sur les pièces répertoriées dans les pages suivantes, reportez-vous au schéma d'assemblage de ce manuel. Déballez et séparez toutes les pièces dans un espace de travail propre.









### **Précautions d'emploi**

7. **NE PAS S'ASSEOIR OU SE TENIR DEBOUT SUR CET ARTICLE.**
8. Ce produit n'est pas un jouet. Ne laissez pas les enfants jouer avec ou à proximité de cet article.
9. Ne pas dépasser la quantité spécifiée capacités de poids.
10. Utiliser uniquement sur une surface plane, de niveau, dure et lisse pouvant supporter en toute sécurité une cloison de séparation en tissu entièrement chargée.
11. Utiliser uniquement comme prévu.

12. Inspectez avant chaque utilisation ; ne pas utiliser si des pièces sont desserrées ou endommagées.

**CONSERVER CE MANUEL**

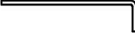
## PARTS LIST

UN		6
B		6
C		6
D		6
E		6
F		2
G		1
H		3
je	 X18	P rechargé

**REMARQUE : Les accessoires F sont des vis de rechange en cadeau ; H est le tissu de l'écran, faites attention à ne pas vous salir lors de l'installation.**

## ASSEMBLY STEP

### ÉTAPE 1

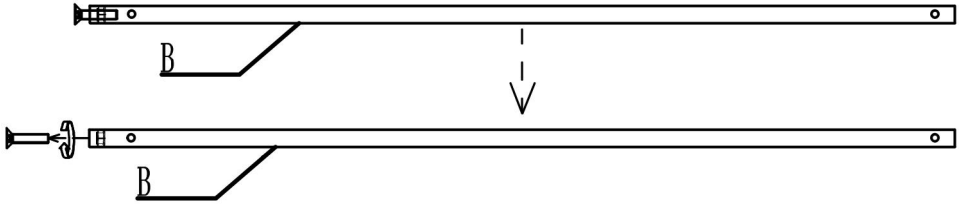

Unscrew from material B and set aside.

# X6

### ÉTAPE 2

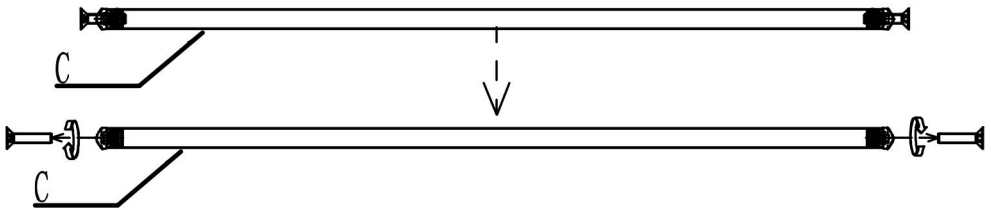

Unscrew from material C and set aside.

# X6

### ÉTAPE 3

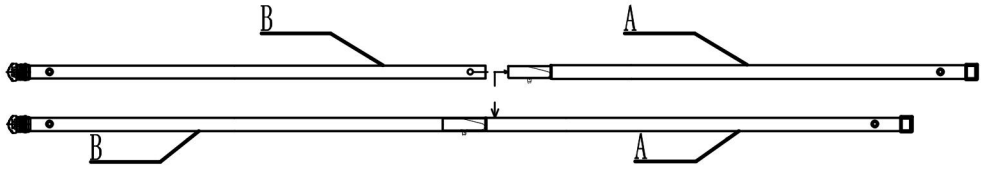

Connect material B and Material A (as shown in the figure) and put them together.

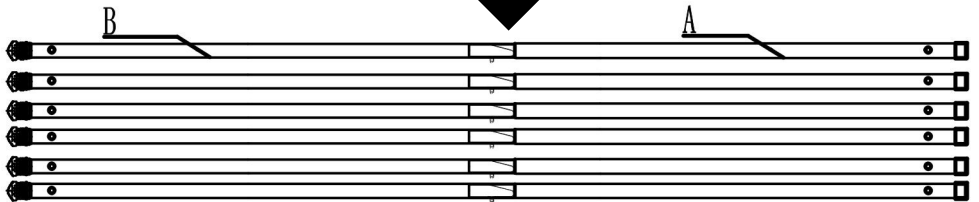

**Total 6 groups**

### ÉTAPE 4

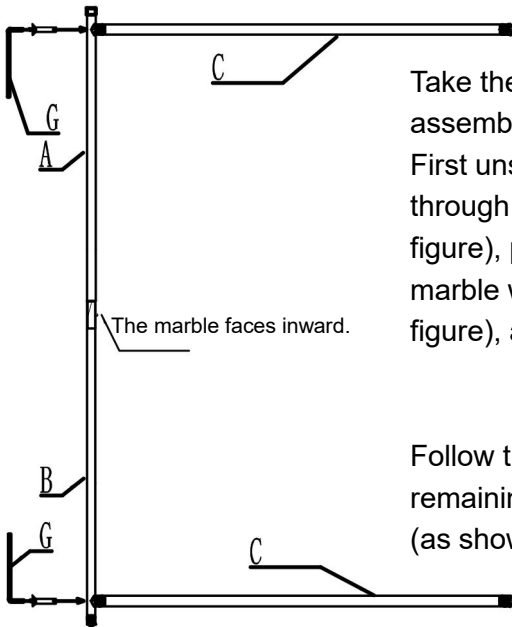

Take the two poles from Step 2 and assemble them on one pole from Step 3. First unscrew the screw, and then connect through the screw (as shown in the figure), pay attention to the position of the marble when combining (as shown in the figure), and then tighten with G tool.

Follow the same steps to connect the remaining 2 groups for a total of 3 groups (as shown)

## ÉTAPE 5



H Material is screen fabric, pay attention to keep clean during installation

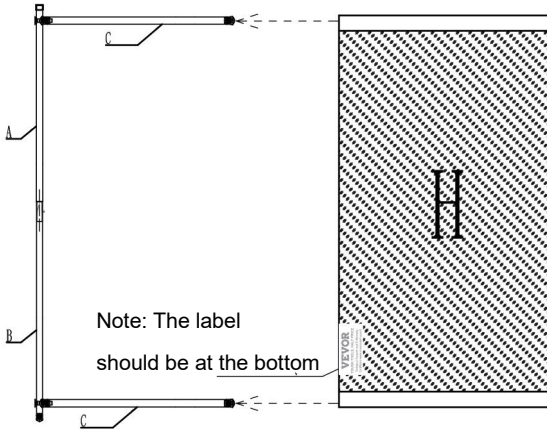

Insert the sleeve of material H into the upper and lower cross bars.

## ÉTAPE 6

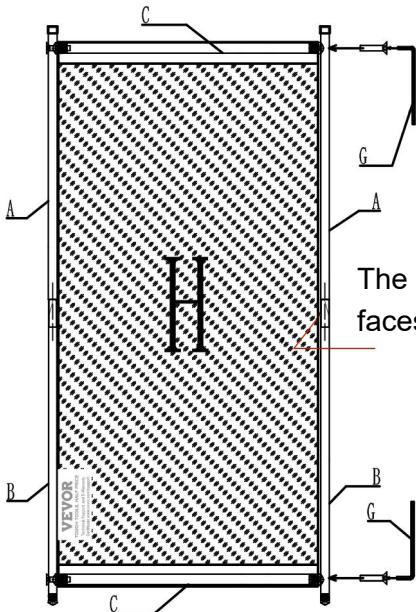

From the remaining tubes in step 3, take a set of tubes, assemble them on the frame, unscrew the screws first, then connect them, and then tighten them with the G tool.

Do the same for the other two groups. Note the position of the marble.

## ÉTAPE 7

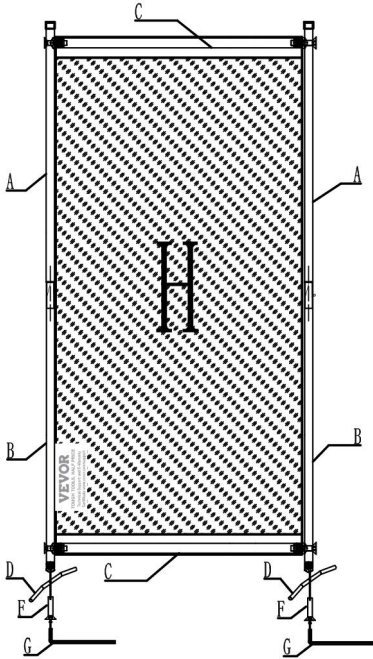

Take material D and assemble it in the frame of step 6. Unscrew the screw first, then connect it, and then tighten it with tool G.

The remaining 2 groups complete the assembly with the same steps.

## ÉTAPE 8

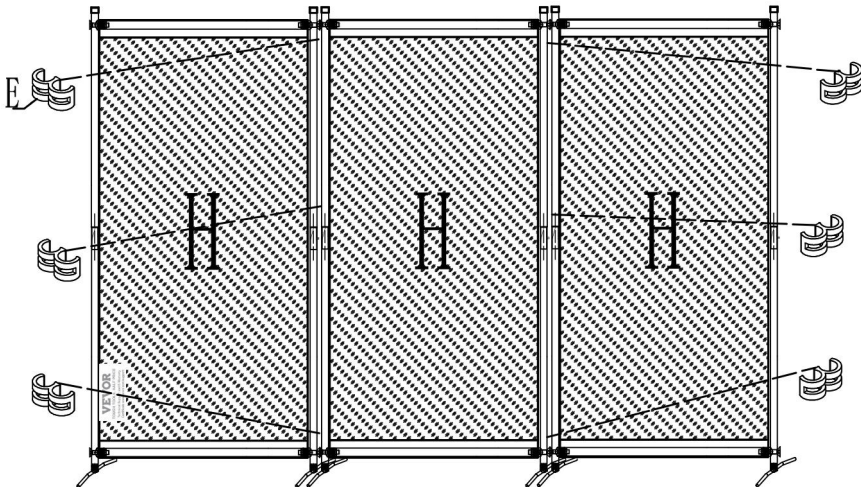

Put the 3 groups of shelves neatly and connect them by material B.

## ÉTAPE 9

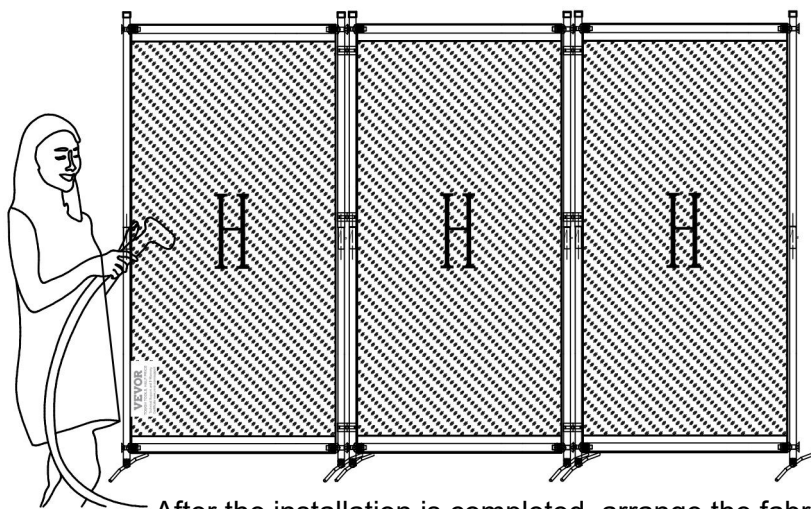

After the installation is completed, arrange the fabric to ensure that the fabric is smooth. If the fabric has wrinkles, you can use a household hanging press to iron it.

## ÉTAPE 10

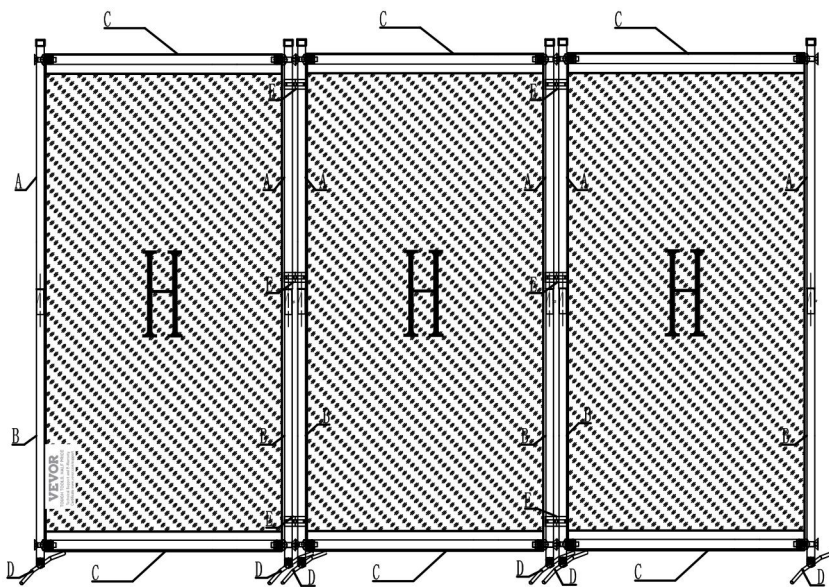

## PRODUCT PARAMETER

<b>Modèle</b>	<b>PFTSTGHS04</b>	<b>PFTSTGSH05</b>	<b>PFTSTGMS06</b>
<b>Couleur</b>	Noir	Gris	Couleur crème
<b>Nombre de panneaux</b>	3		
<b>Taille du produit</b>	2600*1840*520mm		

**Fabricant** : Shangkaimuxinmuyeyouxiangongsi

**Adresse** : Shuangchenglu 803nong11hao1602A-1609shi, baoshanqu,  
Shanghai 200 000 CN.

**Importé en Australie** : SIHAO PTY LTD. 1 ROKEVA  
STREETEASTWOOD

NSW 2122 Australie

**Importé aux États-Unis** : Sanven Technology Ltd. Suite 250, 9166  
Anaheim

Lieu, Rancho Cucamonga, CA 91730

<b>UK</b>	<b>REP</b>
-----------	------------

YH CONSULTING LIMITED. C/O YH Consulting  
Limited Office 147, Centurion House, London  
Road, Staines-upon-Thames, Surrey, TW18 4AX

<b>EC</b>	<b>REP</b>
-----------	------------

E-CrossStu GmbH  
Mainzer Landstr.69,  
60329 Frankfurt am Main.





# **RAUMTEILER AUS STOFF**

## **Benutzerhandbuch**

**PFTSTGHS04**

**PFTSTGSH05**

**PFTSTGMS06**



# FABRIC ROOM DIVIDE

PFTSTGHS04 PFTSTGSH05 PFTSTGMS06

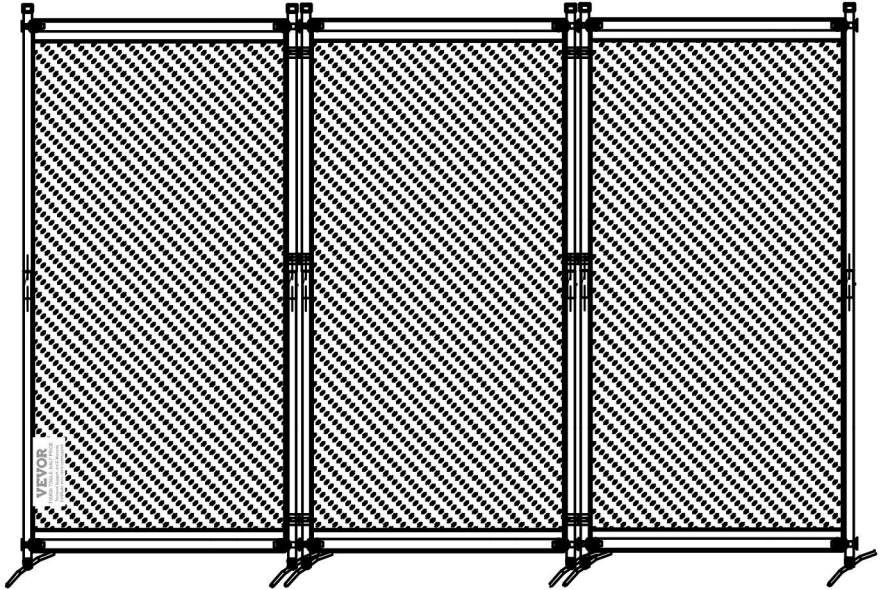



## SAFETY INSTRUCTIONS

### **WARNUNG:**

**Lesen Sie dieses Material, bevor Sie dieses Produkt verwenden. Andernfalls kann es zu schweren Verletzungen kommen.**

### **Vorsichtsmaßnahmen bei der Montage**

17. Führen Sie die Montage nur gemäß dieser Anleitung durch. Eine unsachgemäße Montage kann zu Gefahren führen.
18. Tragen Sie während der Montage eine ANSI-geprüfte Schutzbrille und robuste Arbeitshandschuhe.
19. Halten Sie den Versammlungsbereich sauber und gut beleuchtet.
20. Halten Sie während der Montage unbeteiligte Zuschauer vom Bereich fern.
21. Nicht zusammenbauen, wenn Sie müde sind oder unter Einfluss von Alkohol, Drogen oder Medikamenten stehen.
22. Die Produktfunktionen gelten nur für ordnungsgemäß und vollständig montierte Produkte.
23. Montieren Sie es auf einer flachen, ebenen, harten und glatten Oberfläche, die die Stoff-Raumteiler sicher tragen kann.
24. Weitere Informationen zu den auf den folgenden Seiten aufgeführten Teilen finden Sie im Montagediagramm dieses Handbuchs. Packen Sie alle Teile in einem sauberen Arbeitsbereich aus und trennen Sie sie.









### **Vorsichtsmaßnahmen treffen**

13. SETZEN ODER STELLEN SIE SICH NICHT AUF DIESEN GEGENSTAND.
14. Dieses Produkt ist kein Spielzeug. Erlauben Sie Kindern nicht, mit oder in der Nähe dieses Artikels zu spielen.
15. Überschreiten Sie nicht die angegebenen Gewichtskapazitäten.
16. Nur auf einer flachen, ebenen, harten und glatten Oberfläche verwenden, die eine voll beladene Raumteiler aus Stoff sicher tragen kann.
17. Nur bestimmungsgemäß verwenden.

18. Vor jedem Gebrauch prüfen; nicht verwenden, wenn Teile lose oder beschädigt sind.

**BEWAHREN SIE DIESES HANDBUCH AUF**

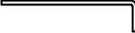
## PARTS LIST

A		6
B		6
C		6
D		6
E		6
F		2
G		1
H		3
ICH	 X18	Vorgeladen

**HINWEIS : Bei Zubehör F handelt es sich um Ersatzschrauben als Geschenk; H ist der Stoff des Bildschirms. Achten Sie darauf, dass er bei der Installation nicht schmutzig wird.**

## ASSEMBLY STEP

### SCHRITT 1

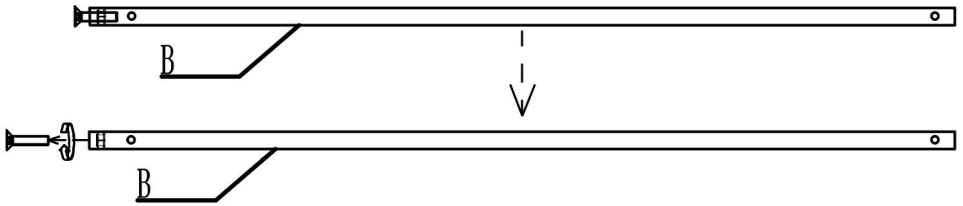

Unscrew from material B and set aside.

# X6

### SCHRITT 2

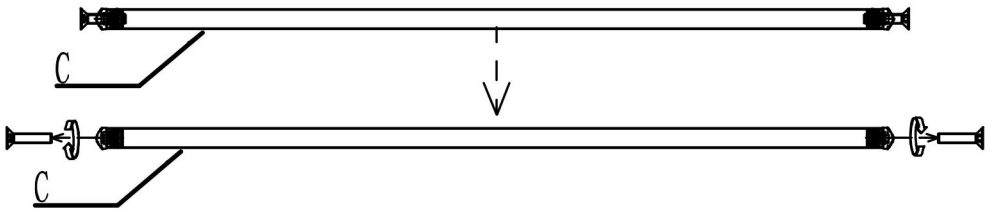

Unscrew from material C and set aside.

# X6

### SCHRITT 3

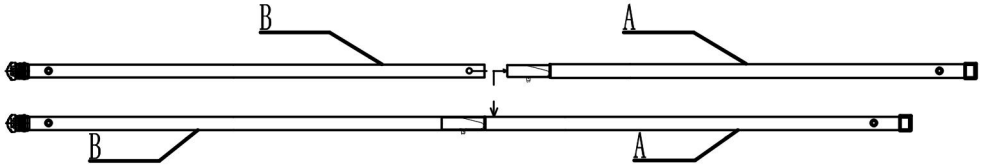

Connect material B and Material A (as shown in the figure) and put them together.

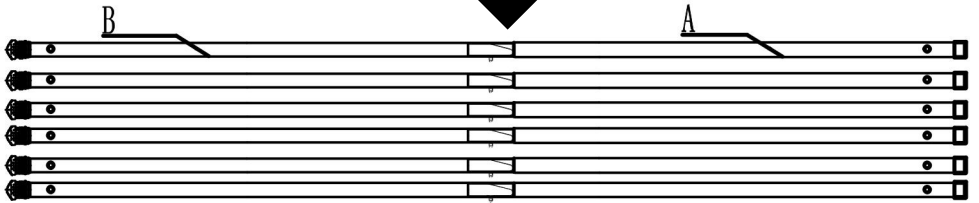

**Total 6 groups**

### SCHRITT 4

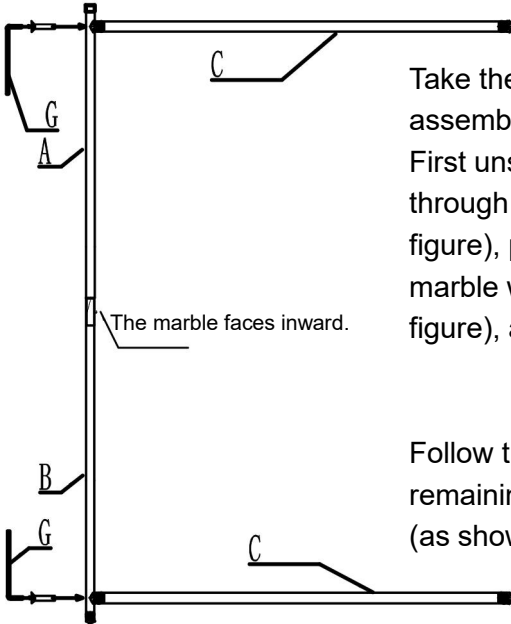

Take the two poles from Step 2 and assemble them on one pole from Step 3. First unscrew the screw, and then connect through the screw (as shown in the figure), pay attention to the position of the marble when combining (as shown in the figure), and then tighten with G tool.

Follow the same steps to connect the remaining 2 groups for a total of 3 groups (as shown)

## SCHRITT 5



H Material is screen fabric, pay attention to keep clean during installation

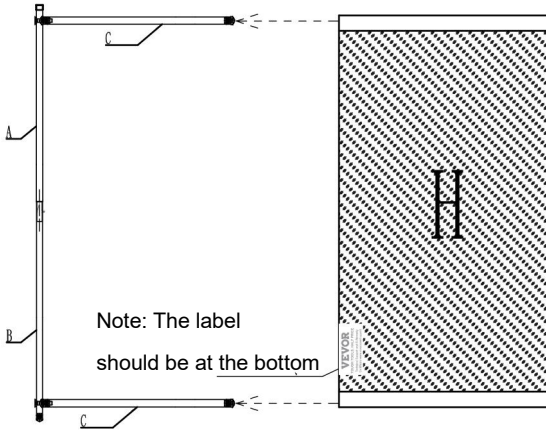

Insert the sleeve of material H into the upper and lower cross bars.

## SCHRITT 6

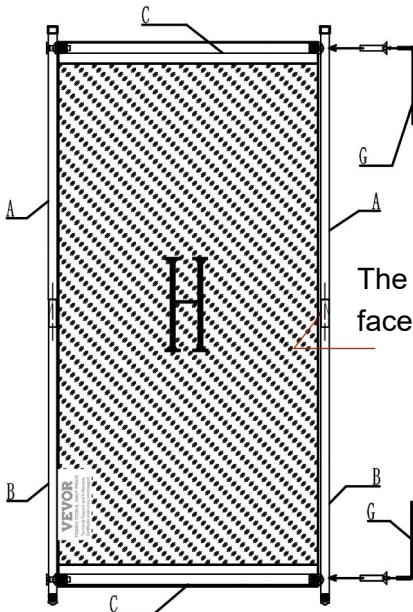

From the remaining tubes in step 3, take a set of tubes, assemble them on the frame, unscrew the screws first, then connect them, and then tighten them with the G tool.

Do the same for the other two groups. Note the position of the marble.

## SCHRITT 7

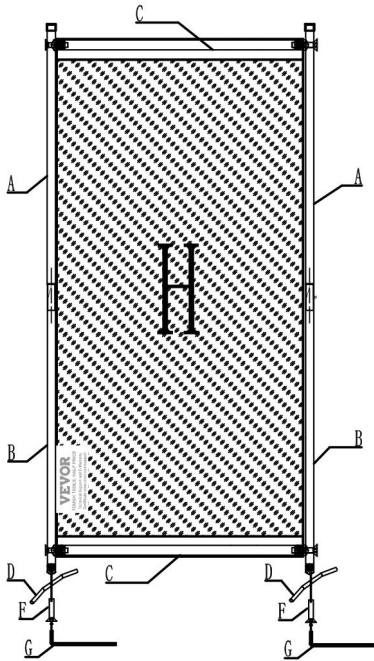

Take material D and assemble it in the frame of step 6. Unscrew the screw first, then connect it, and then tighten it with tool G.

The remaining 2 groups complete the assembly with the same steps.

## SCHRITT 8

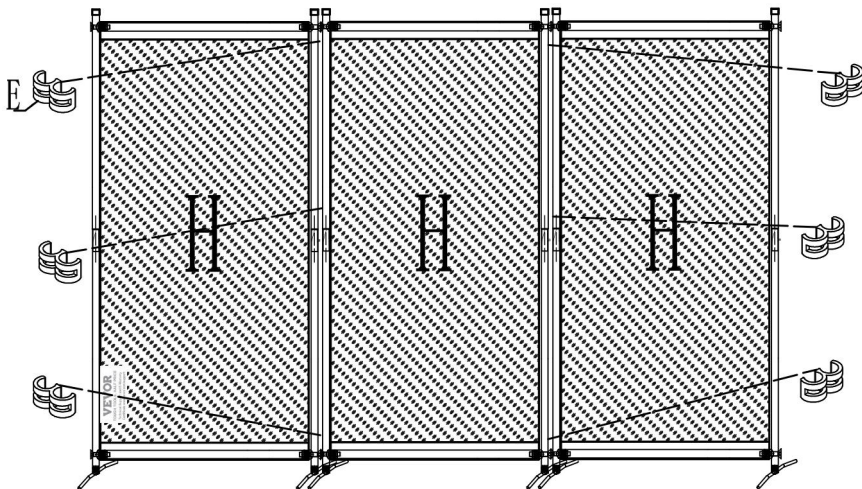

Put the 3 groups of shelves neatly and connect them by material B.

## SCHRITT 9

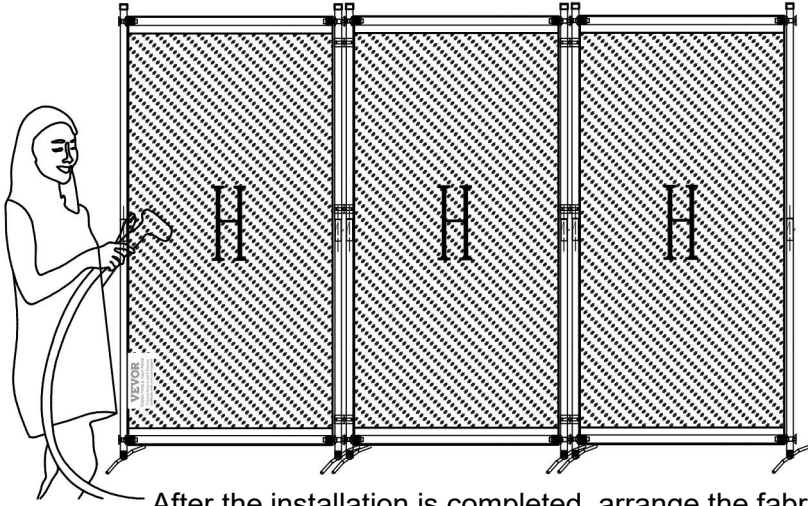

After the installation is completed, arrange the fabric to ensure that the fabric is smooth. If the fabric has wrinkles, you can use a household hanging press to iron it.

## SCHRITT 10

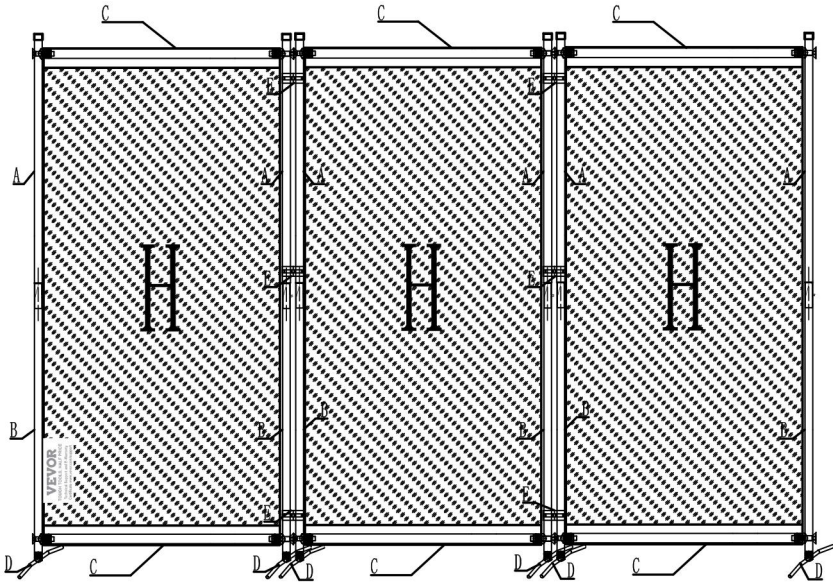

## PRODUCT PARAMETER

<b>Modell</b>	<b>PFTSTGHS04</b>	<b>PFTSTGSH05</b>	<b>PFTSTGMS06</b>
<b>Farbe</b>	Schwarz	Grau	Cremerfarben
<b>Anzahl der Panels</b>	3		
<b>Produktgröße</b>	2600 x 1840 x 520 mm		

**Hersteller:** Shanghai muxinmuyeyouxiangongsi

**Adresse:** Shuangchenglu 803nong11hao1602A-1609shi, baoshanqu, Shanghai, 200.000 CN.

**Nach AUS importiert:** SIHAO PTY LTD. 1 ROKEVA STREETEASTWOOD

NSW 2122 Australien

**Importiert in die USA:** Sanven Technology Ltd. Suite 250, 9166 Anaheim Ort, Rancho Cucamonga, CA 91730

<b>UK</b>	<b>REP</b>
-----------	------------

YH CONSULTING LIMITED. C/O YH Consulting Limited Office 147, Centurion House, London Road, Staines-upon-Thames, Surrey, TW18 4AX

<b>EC</b>	<b>REP</b>
-----------	------------

E-CrossStu GmbH  
Mainzer Landstr.69,  
60329 Frankfurt am Main.





# **DIVISORIO IN TESSUTO**

## **MANUALE D' uso**

**PFTSGHS04**

**PFTSTGSH05**

**PFTSGMS06**

# FABRIC ROOM DIVIDE

PFTSGHS04 PFTSTGSH05 PFTSGMS06

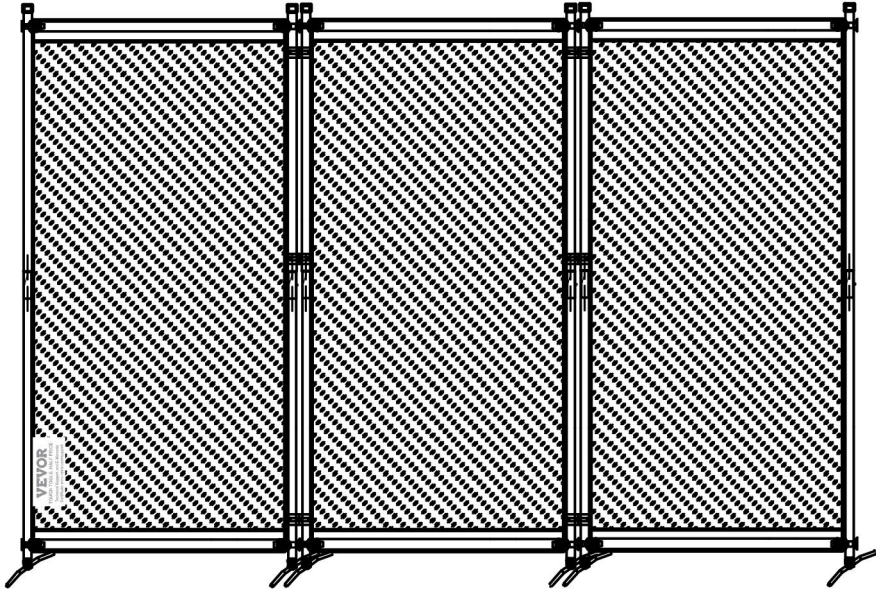



## SAFETY INSTRUCTIONS

### **AVVERTIMENTO:**

**Leggere questo materiale prima di utilizzare questo prodotto. La mancata osservanza di questa precauzione può causare gravi lesioni.**

### **Precauzioni di montaggio**









25. Montare solo secondo queste istruzioni. Un montaggio improprio può creare pericoli.
26. Durante il montaggio, indossare occhiali di sicurezza omologati ANSI e guanti da lavoro resistenti.
27. Mantenere l'area di riunione pulita e ben illuminata.
28. Durante l'assemblea, tenere gli astanti lontani dall'area.
29. Non riunirsi se si è stanchi o sotto l'effetto di alcol, droghe o farmaci.
30. Le capacità del prodotto si applicano solo ai prodotti correttamente e completamente assemblati.
31. Montare su una superficie piana, livellata, dura e liscia, in grado di sostenere in modo sicuro il divisorio in tessuto.
32. Per ulteriori informazioni sulle parti elencate nelle pagine seguenti, fare riferimento allo schema di montaggio di questo manuale. Disimballare e separare tutte le parti in un'area di lavoro pulita.

### **Usare precauzioni**

19. **NON SEDERSI O STARE IN PIEDI SU QUESTO OGGETTO.**
20. Questo prodotto non è un giocattolo. Non permettere ai bambini di giocare con o vicino a questo articolo.
21. Non superare i limiti specificati capacità di peso.
22. Utilizzare solo su una superficie piana, livellata, dura e liscia in grado di sostenere in modo sicuro un divisorio in tessuto completamente carico.
23. Utilizzare solo come previsto.
24. Ispezionare prima di ogni utilizzo; non utilizzare se alcune parti risultano allentate o danneggiate.

**SALVA QUESTO MANUALE**

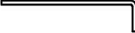
## PARTS LIST

UN		6
B		6
C		6
D		6
E		6
F		2
G		1
H		3
IO	 X18	Pre ricaricato

**NOTA : gli accessori F sono viti di ricambio in regalo; H è il tessuto dello schermo, fare attenzione a non sporcarlo durante l'installazione.**

## ASSEMBLY STEP

### PASSO 1

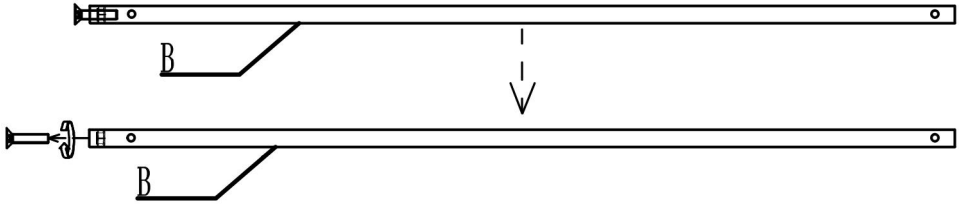

Unscrew from material B and set aside.

# X6

### PASSO 2

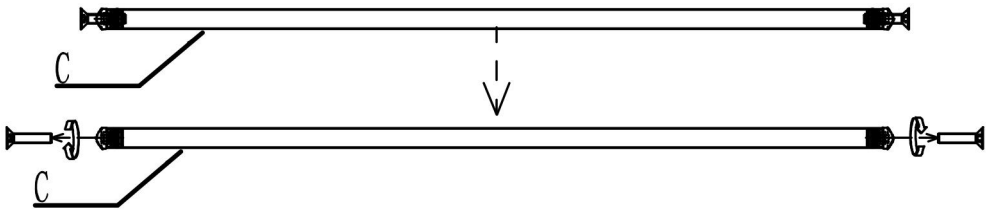

Unscrew from material C and set aside.

# X6

### PASSO 3

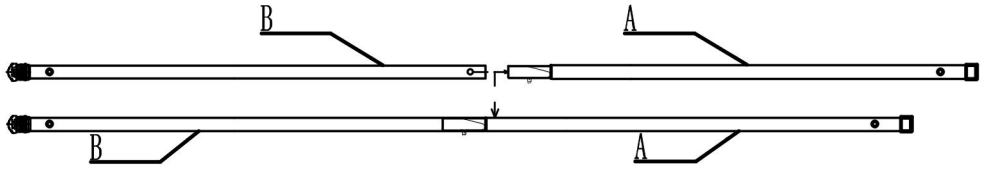

Connect material B and Material A (as shown in the figure) and put them together.

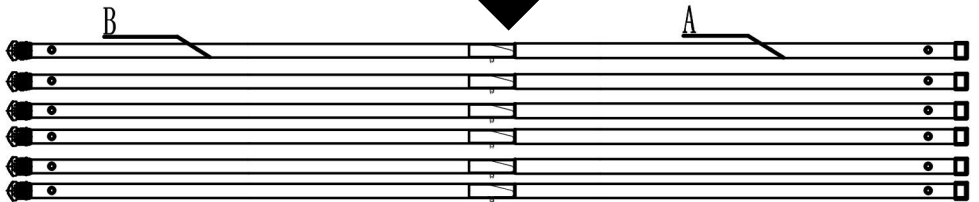

**Total 6 groups**

### PASSO 4

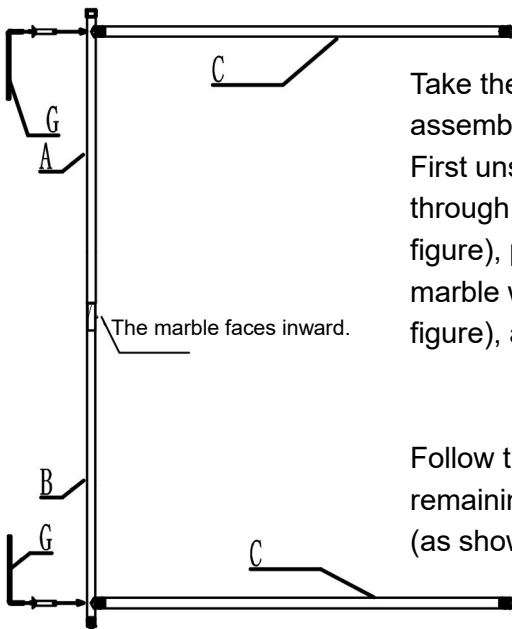

Take the two poles from Step 2 and assemble them on one pole from Step 3. First unscrew the screw, and then connect through the screw (as shown in the figure), pay attention to the position of the marble when combining (as shown in the figure), and then tighten with G tool.

Follow the same steps to connect the remaining 2 groups for a total of 3 groups (as shown)

## PASSO 5



H Material is screen fabric, pay attention to keep clean during installation

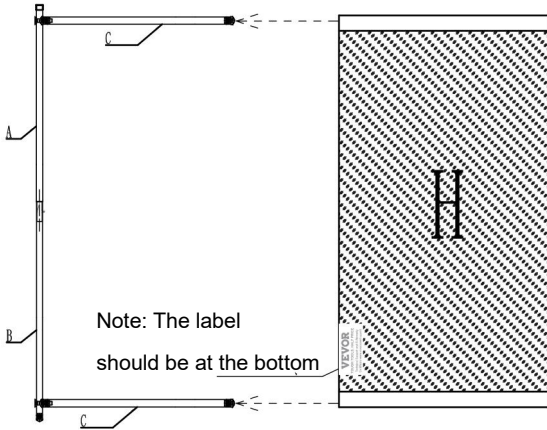

Insert the sleeve of material H into the upper and lower cross bars.

## PASSO 6

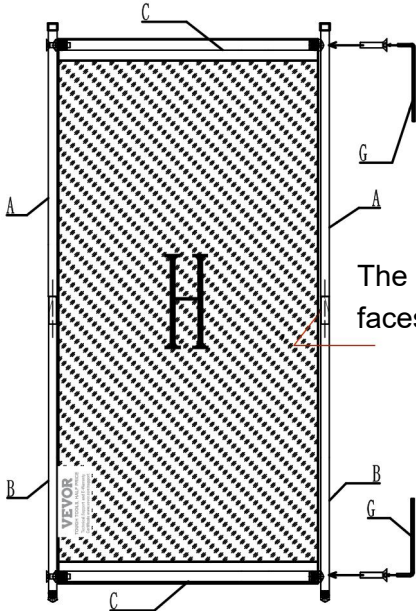

The marble faces inward.

From the remaining tubes in step 3, take a set of tubes, assemble them on the frame, unscrew the screws first, then connect them, and then tighten them with the G tool.

Do the same for the other two groups. Note the position of the marble.

## PASSO 7

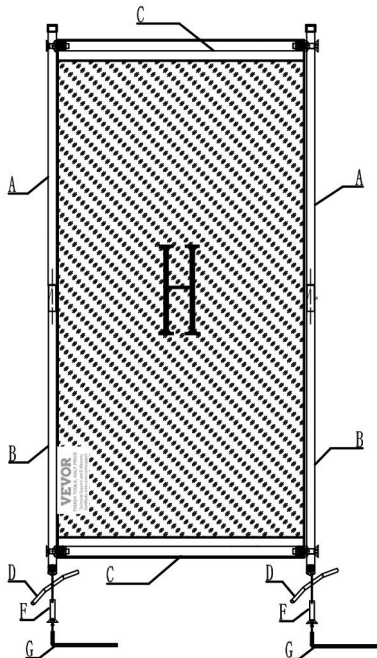

Take material D and assemble it in the frame of step 6. Unscrew the screw first, then connect it, and then tighten it with tool G.

The remaining 2 groups complete the assembly with the same steps.

## PASSO 8

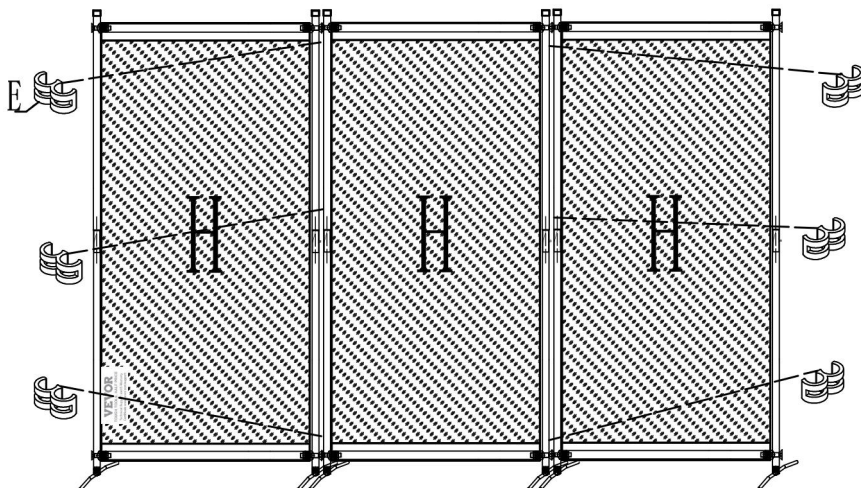

Put the 3 groups of shelves neatly and connect them by material B.

## PASSO 9

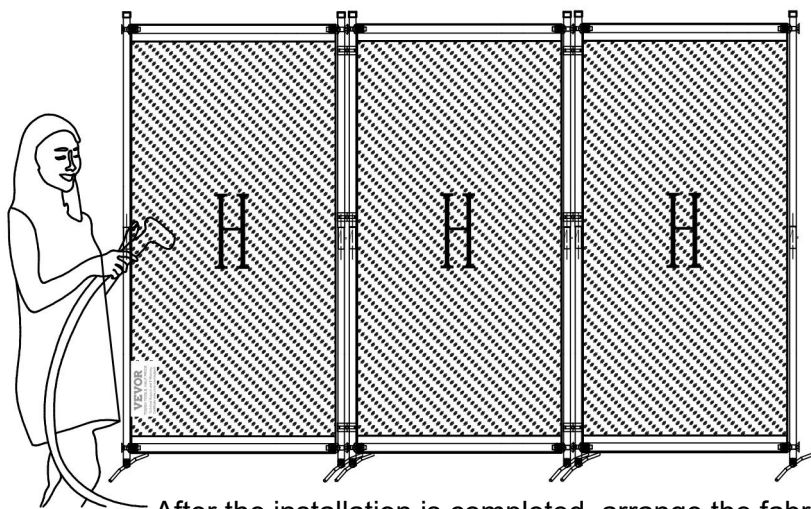

After the installation is completed, arrange the fabric to ensure that the fabric is smooth. If the fabric has wrinkles, you can use a household hanging press to iron it.

## PASSO 10

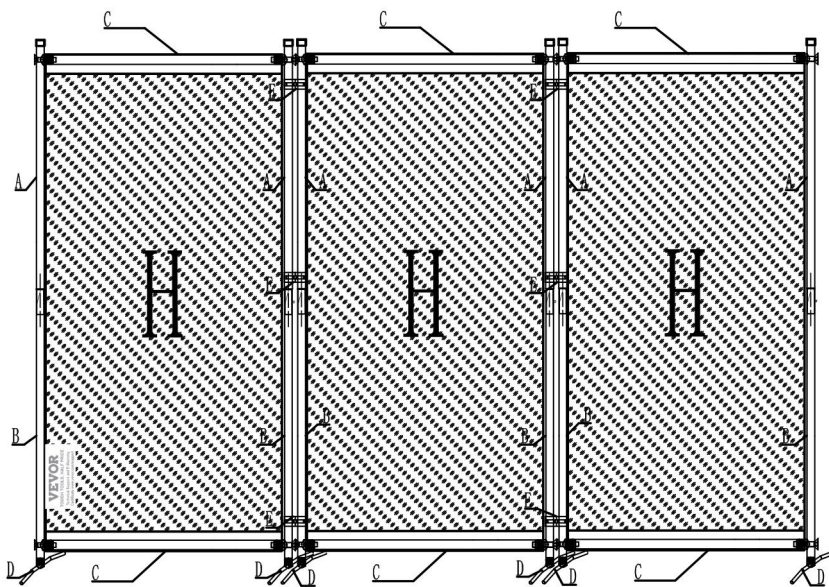

## PRODUCT PARAMETER

<b>Modello</b>	<b>PFTSGHS04</b>	<b>PFTSTGSH05</b>	<b>PFTSGMS06</b>
<b>Colore</b>	Nero	Grigio	C ome crema
<b>Numero di pannelli</b>	3		
<b>Dimensioni del prodotto</b>	2600*1840*520mm		

**Produttore:** Shanghaimuxinmuyeyouxiangongsi

**Indirizzo:** Shuangchenglu 803nong11hao1602A-1609shi, baoshanqu, shanghai 200000 CN.

**Importato in AUS:** SIHAO PTY LTD. 1 ROKEVA STREETEASTWOOD  
Nuovo Galles del Sud 2122 Australia

**Importato negli USA:** Sanven Technology Ltd. Suite 250, 9166 Anaheim  
Luogo, Rancho Cucamonga, CA 91730

<b>UK</b>	<b>REP</b>
-----------	------------

YH CONSULTING LIMITED. C/O YH Consulting  
Limited Office 147, Centurion House, London  
Road, Staines-upon-Thames, Surrey, TW18 4AX

<b>EC</b>	<b>REP</b>
-----------	------------

E-CrossStu GmbH  
Mainzer Landstr.69,  
60329 Frankfurt am Main.



# **DIVIDIR HABITACIÓN CON TELA de USUARIO**

**PFTSTGHS04**

**PFTSTGSH05**

**PFTSTGMS06**



# FABRIC ROOM DIVIDE

PFTSTGHS04 PFTSTGSH05 PFTSTGMS06

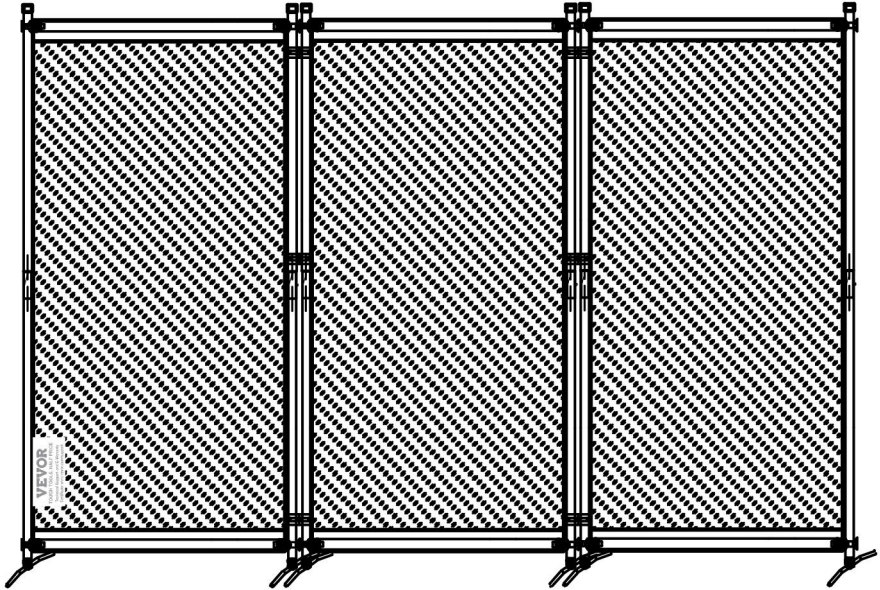



## SAFETY INSTRUCTIONS

### **ADVERTENCIA:**

**Lea este material antes de utilizar este producto. No hacerlo puede provocar lesiones graves.**

### **Precauciones de montaje**

33. Realice el montaje únicamente de acuerdo con estas instrucciones. Un montaje inadecuado puede generar peligros.
34. Use gafas de seguridad aprobadas por ANSI y guantes de trabajo resistentes durante el montaje.
35. Mantenga el área de reunión limpia y bien iluminada.
36. Mantenga a los transeúntes fuera del área durante el montaje.
37. No se reúna si está cansado o bajo la influencia del alcohol, drogas o medicamentos.
38. Las capacidades del producto se aplican únicamente a productos ensamblados de forma correcta y completa.
39. Móntelo sobre una superficie plana, nivelada, dura y lisa capaz de soportar de forma segura el divisor de ambientes de tela.
40. Para obtener información adicional sobre las piezas que se enumeran en las páginas siguientes, consulte el diagrama de ensamblaje de este manual. Desembale y separe todas las piezas en un área de trabajo limpia.









### **Tome precauciones**

25. NO SE SIENTA NI SE PARE SOBRE ESTE ARTÍCULO.
26. Este producto no es un juguete. No permita que los niños jueguen con este artículo ni cerca de él.
27. No exceda lo especificado Capacidades de peso.
28. Úselo únicamente sobre una superficie plana, nivelada, dura y lisa que pueda soportar de manera segura un divisor de ambientes de tela completamente cargado.
29. Úselo únicamente según lo previsto.
30. Inspeccione antes de cada uso; no utilice si las piezas están sueltas o

dañadas.

**GUARDE ESTE MANUAL**

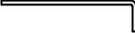
## PARTS LIST

A		6
B		6
do		6
D		6
mi		6
F		2
GRAMO		1
yo		3
I	 X18	P recargado

**NOTA : Los accesorios F son tornillos de repuesto para regalo; H es la tela de la pantalla, preste atención para no ensuciarse durante la instalación.**

## ASSEMBLY STEP

### PASO 1

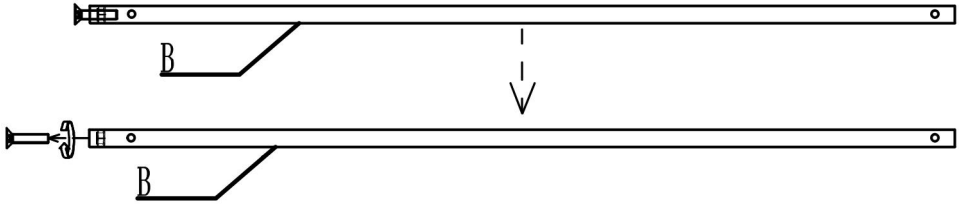

Unscrew from material B and set aside.

# X6

### PASO 2

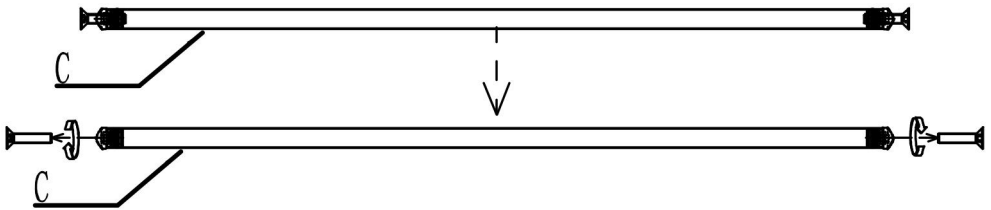

Unscrew from material C and set aside.

# X6

### PASO 3

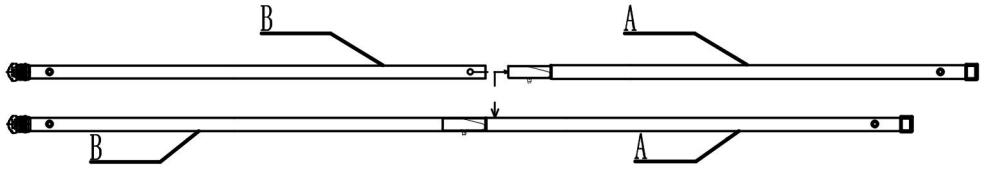

Connect material B and Material A (as shown in the figure) and put them together.

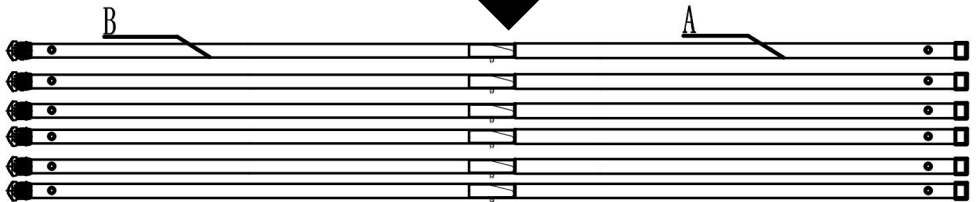

**Total 6 groups**

### PASO 4

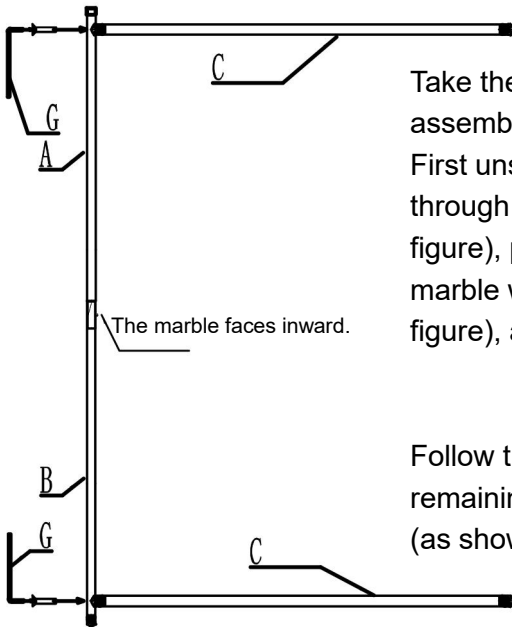

Take the two poles from Step 2 and assemble them on one pole from Step 3. First unscrew the screw, and then connect through the screw (as shown in the figure), pay attention to the position of the marble when combining (as shown in the figure), and then tighten with G tool.

Follow the same steps to connect the remaining 2 groups for a total of 3 groups (as shown)

## PASO 5



H Material is screen fabric, pay attention to keep clean during installation

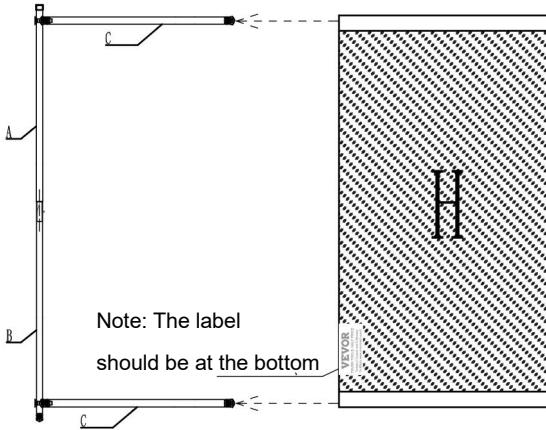

Insert the sleeve of material H into the upper and lower cross bars.

## PASO 6

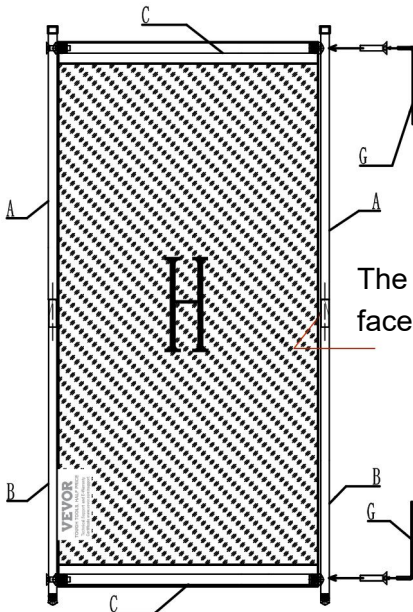

From the remaining tubes in step 3, take a set of tubes, assemble them on the frame, unscrew the screws first, then connect them, and then tighten them with the G tool.

Do the same for the other two groups. Note the position of the marble.

## PASO 7

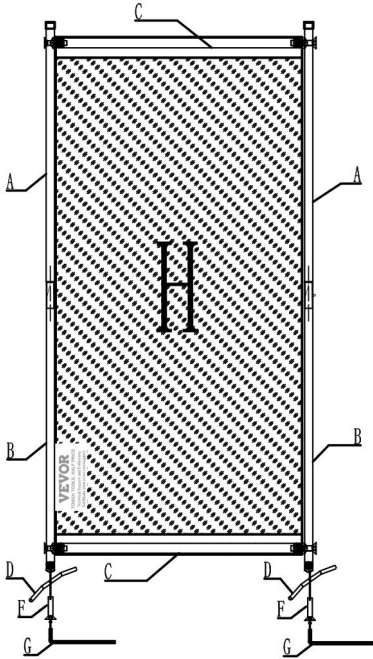

Take material D and assemble it in the frame of step 6. Unscrew the screw first, then connect it, and then tighten it with tool G.

The remaining 2 groups complete the assembly with the same steps.

## PASO 8

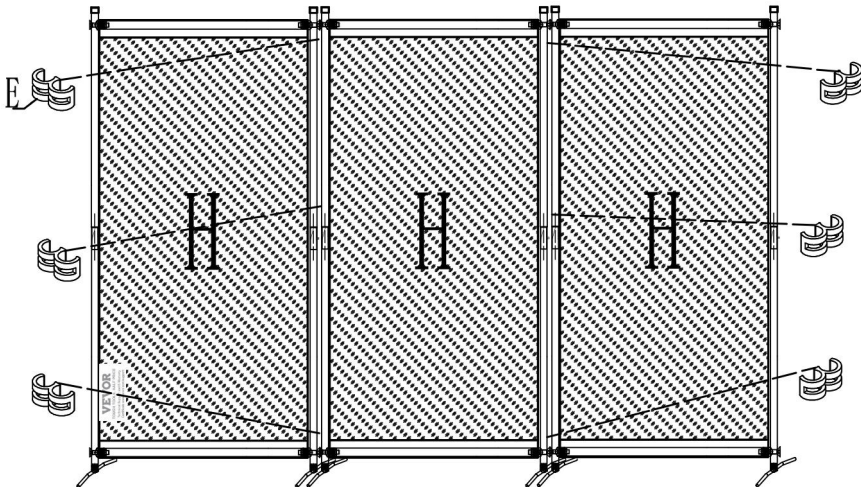

Put the 3 groups of shelves neatly and connect them by material B.

## PASO 9

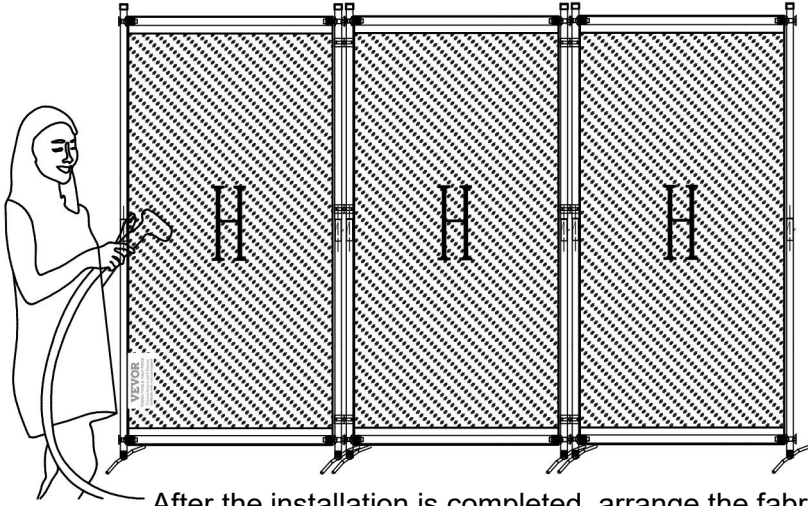

After the installation is completed, arrange the fabric to ensure that the fabric is smooth. If the fabric has wrinkles, you can use a household hanging press to iron it.

## PASO 10

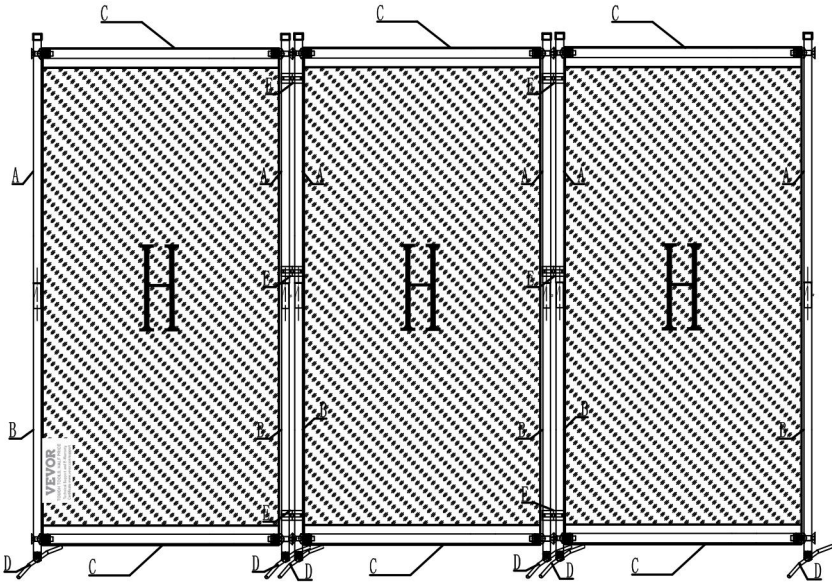

## PRODUCT PARAMETER

<b>Modelo</b>	<b>PFTSTGHS04</b>	<b>PFTSTGSH05</b>	<b>PFTSTGMS06</b>
<b>Color</b>	Negro	Gris	C rema- Color
<b>Número de paneles</b>	3		
<b>Tamaño del producto</b>	2600*1840*520 mm		

**Fabricante:** Shanghaimuxinmuyeyouxiangongsi

**Dirección:** Shuangchenglu 803nong11hao1602A-1609shi, baoshanqu, Shanghai 200000 CN.

**Importado a Australia:** SIHAO PTY LTD. 1 ROKEVA STREETEASTWOOD

Nueva Gales del Sur 2122 Australia

**Importado a EE. UU.:** Sanven Technology Ltd. Suite 250, 9166 Anaheim Lugar, Rancho Cucamonga, CA 91730

<b>UK</b>	<b>REP</b>
-----------	------------

YH CONSULTING LIMITED. C/O YH Consulting Limited Office 147, Centurion House, London Road, Staines-upon-Thames, Surrey, TW18 4AX

<b>EC</b>	<b>REP</b>
-----------	------------

E-CrossStu GmbH  
Mainzer Landstr.69,  
60329 Frankfurt am Main.





**PRZEGRODA POKOJU Z TKANINY**  
**INSTRUKCJA obsługi**

**PFTSTGHS04**  
**PFSTSTGSH05**  
**PFSTSGMS06**

# FABRIC ROOM DIVIDE

PFTSTGHS04 PFSTSTGSH05 PFSTSGMS06

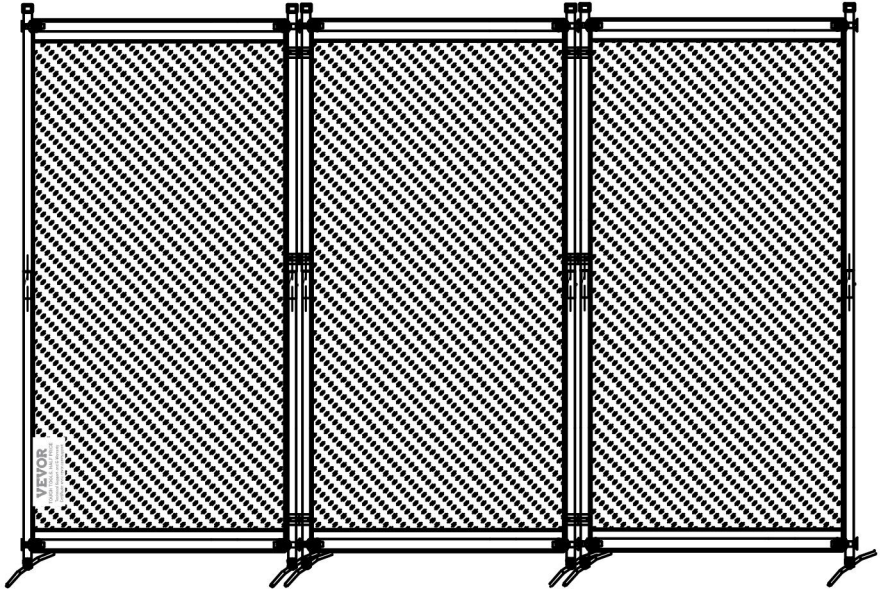



## SAFETY INSTRUCTIONS

### **OSTRZEŻENIE:**

**Przeczytaj ten materiał przed użyciem tego produktu.**

**Nieprzestrzeżenie tego może spowodować poważne obrażenia.**

### **Środki ostrożności podczas montażu**

41. Montaż należy wykonywać wyłącznie zgodnie z niniejszą instrukcją. Nieprawidłowy montaż może stwarzać zagrożenia.
42. Podczas montażu należy nosić okulary ochronne z atestem ANSI oraz wytrzymałe rękawice robocze.
43. Utrzymuj miejsce zgromadzenia w czystości i zapewnij dobre oświetlenie.
44. Nie dopuszczaj osób postronnych na teren montażu podczas jego trwania.
45. Nie przychodź na spotkanie, jeśli jesteś zmęczony lub znajdujesz się pod wpływem alkoholu, narkotyków lub leków.
46. Możliwości produktu odnoszą się wyłącznie do produktów prawidłowo i kompletnie zmontowanych.
47. Zamontuj na płaskiej, równej, twardej i gładkiej powierzchni, która będzie w stanie bezpiecznie utrzymać ściankę działową Fabric Room Divide.
48. Aby uzyskać dodatkowe informacje dotyczące części wymienionych na kolejnych stronach, zapoznaj się ze schematem montażu w tym podręczniku. Rozpakuj i oddziel wszystkie części w czystym miejscu pracy.

### **Stosuj środki ostrożności**

31. NIE SIADAĆ ANI NIE STAWAĆ NA TYM PRZEDMIOCIE.
32. Ten produkt nie jest zabawką. Nie pozwalaj dzieciom bawić się tym przedmiotem ani przebywać w jego pobliżu.
33. Nie przekraczać określonej nośności.
34. Stosować wyłącznie na płaskiej, równej, twardej i gładkiej powierzchni, która może bezpiecznie utrzymać w pełni załadowaną ściankę









działową Fabric Room Divide.

35. Stosować wyłącznie zgodnie z przeznaczeniem.

36. Przed każdym użyciem należy przeprowadzić kontrolę. Nie należy używać produktu, jeśli jakieś części są luźne lub uszkodzone.

**ZAPISZ TĘ INSTRUKCJĘ**

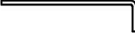
## PARTS LIST

A		6
B		6
C		6
D		6
mi		6
F		2
G		1
H		3
I	 X18	Wstępnie załadowane

**UWAGA : Akcesoria F to zapasowe śrubki do kupienia w prezencje; H to materiał ekranu, należy uważać, aby się nie zabrudził podczas instalacji.**

## ASSEMBLY STEP

### KROK 1

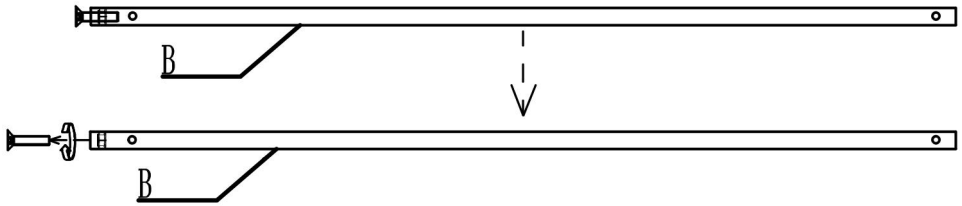

Unscrew from material B and set aside.

# X6

### KROK 2

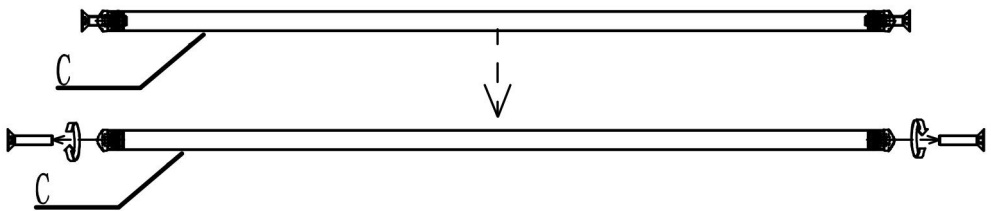

Unscrew from material C and set aside.

# X6

### KROK 3

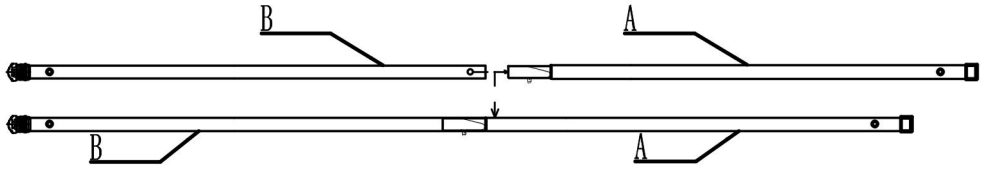

Connect material B and Material A (as shown in the figure) and put them together.

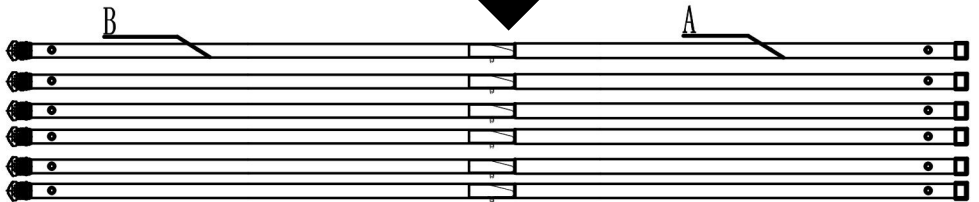

**Total 6 groups**

### KROK 4

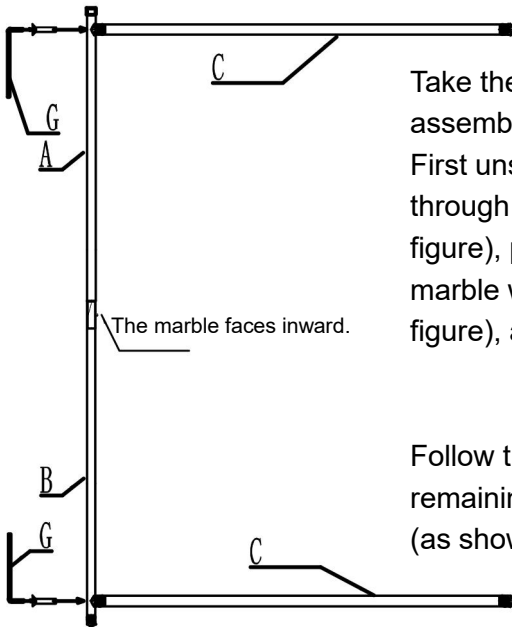

Take the two poles from Step 2 and assemble them on one pole from Step 3. First unscrew the screw, and then connect through the screw (as shown in the figure), pay attention to the position of the marble when combining (as shown in the figure), and then tighten with G tool.

Follow the same steps to connect the remaining 2 groups for a total of 3 groups (as shown)

## KROK 5



H Material is screen fabric, pay attention to keep clean during installation

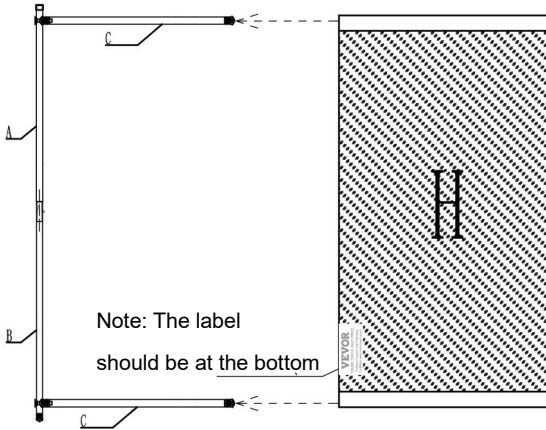

Insert the sleeve of material H into the upper and lower cross bars.

## KROK 6

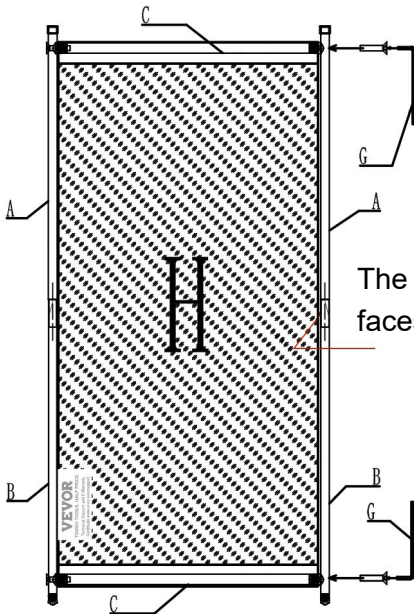

From the remaining tubes in step 3, take a set of tubes, assemble them on the frame, unscrew the screws first, then connect them, and then tighten them with the G tool.

Do the same for the other two groups. Note the position of the marble.

## KROK 7

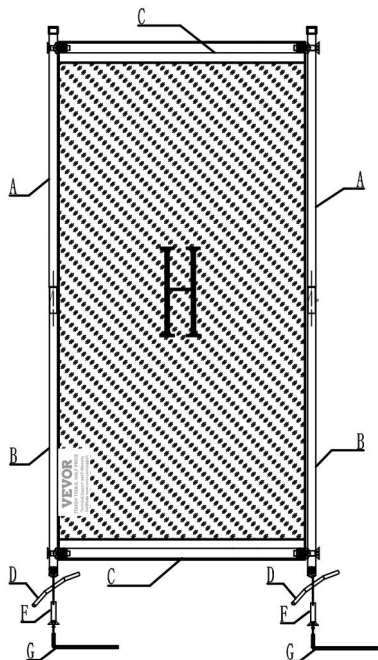

Take material D and assemble it in the frame of step 6. Unscrew the screw first, then connect it, and then tighten it with tool G.

The remaining 2 groups complete the assembly with the same steps.

## KROK 8

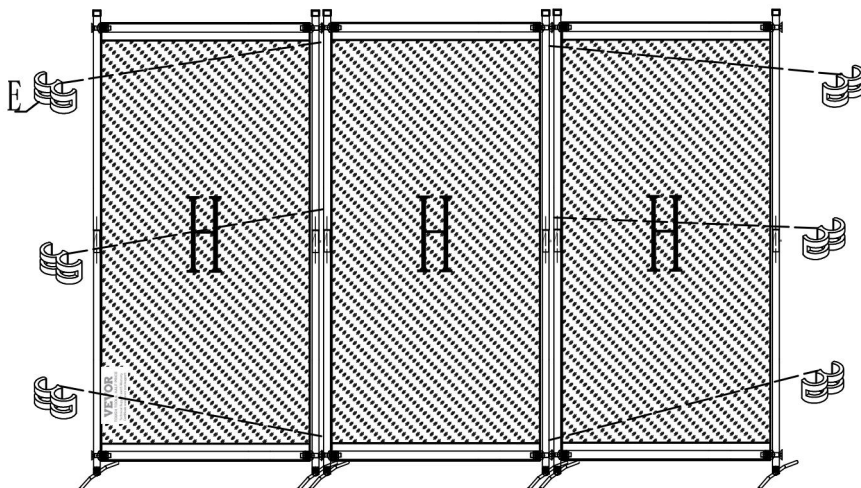

Put the 3 groups of shelves neatly and connect them by material B.

## KROK 9

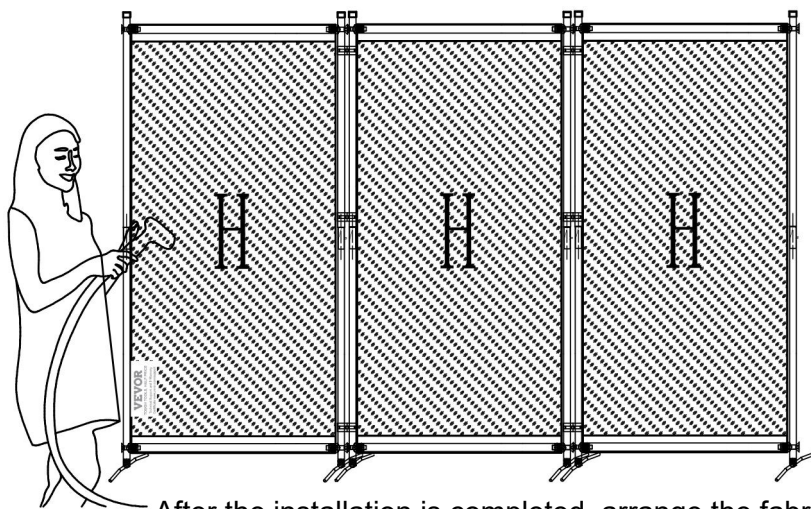

After the installation is completed, arrange the fabric to ensure that the fabric is smooth. If the fabric has wrinkles, you can use a household hanging press to iron it.

## KROK 10

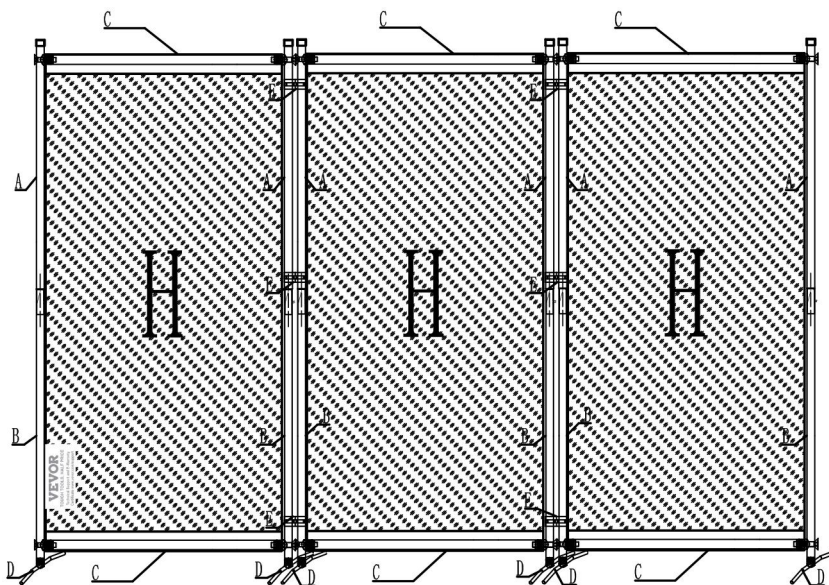

## PRODUCT PARAMETER

<b>Model</b>	<b>PFTSTGHS04</b>	<b>Pfststgsh05</b>	<b>Pfstsgms06</b>
<b>Kolor</b>	Czarny	Szary	Kremowy - Kolorowy
<b>Liczba paneli</b>	3		
<b>Rozmiar produktu</b>	2600*1840*520 mm		

**Producent:** Shanghaimuxinmuyeyouxiangongsi

**Adres:** Shuangchenglu 803nong11hao1602A-1609shi, baoshanqu,  
Szanghaj 200000 CN.

**Importowane do AUS:** SIHAO PTY LTD. 1 ROKEVA  
STREETEASTWOOD

NSW 2122 Australia

**Importowane do USA:** Sanven Technology Ltd. Suite 250, 9166 Anaheim  
Miejsce, Rancho Cucamonga, CA 91730

<b>UK</b>	<b>REP</b>
-----------	------------

YH CONSULTING LIMITED. C/O YH Consulting  
Limited Office 147, Centurion House, London  
Road, Staines-upon-Thames, Surrey, TW18 4AX

<b>EC</b>	<b>REP</b>
-----------	------------

E-CrossStu GmbH  
Mainzer Landstr.69,  
60329 Frankfurt am Main.





# **STOFFEN KAMERVERDELING**

## **Gebruikershandleiding**

**PFTSTGHS04**

**PFTSTGSH05**

**PFTSTGMS06**



# FABRIC ROOM DIVIDE

PFTSTGHS04 PFTSTGSH05 PFTSTGMS06

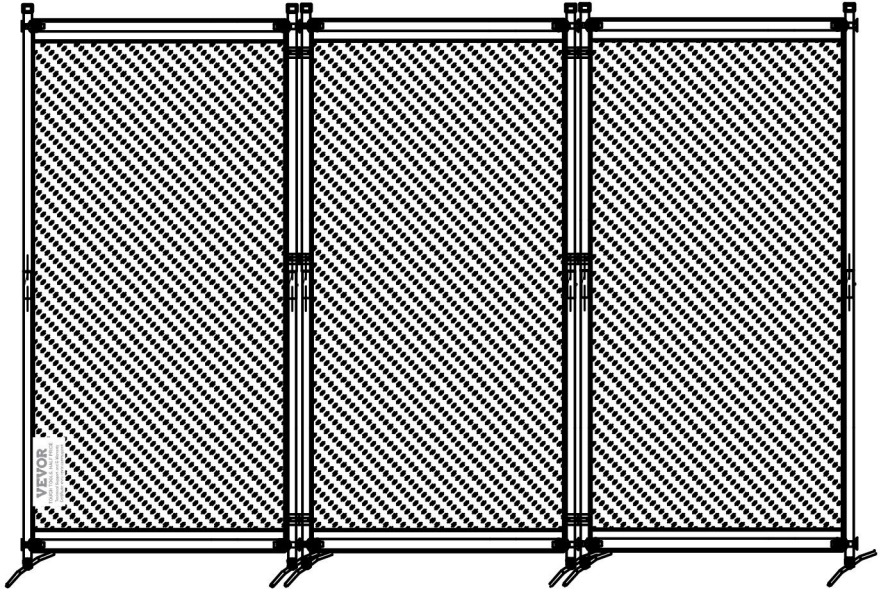



## SAFETY INSTRUCTIONS

### **WAARSCHUWING:**

**Lees dit materiaal voordat u dit product gebruikt. Als u dit niet doet, kan dit leiden tot ernstig letsel.**

### **Voorzorgsmaatregelen bij de montage**

49. Monteer alleen volgens deze instructies. Onjuiste montage kan gevaaren opleveren.
50. Draag tijdens de montage een ANSI-goedgekeurde veiligheidsbril en stevige werkhandschoenen.
51. Zorg ervoor dat de verzamelplaats schoon en goed verlicht is.
52. Houd omstanders uit de buurt tijdens de montage.
53. Kom niet bijeen als u moe bent of onder invloed van alcohol, drugs of medicijnen.
54. De producteigenschappen gelden uitsluitend voor correct en volledig gemonteerde producten.
55. Monteer de Fabric Room Divide op een vlak, egaal, hard en glad oppervlak dat de Fabric Room Divide veilig kan dragen.
56. Voor aanvullende informatie over de onderdelen die op de volgende pagina's worden vermeld, raadpleegt u het montageschema van deze handleiding. Pak alle onderdelen uit en scheid ze in een schone werkruimte.









### **Neem voorzorgsmaatregelen**

37. NIET OP DIT ARTIKEL ZITTEN OF STAAN.
38. Dit product is geen speelgoed. Laat kinderen niet met of in de buurt van dit item spelen.
39. Overschrijd de aangegeven waarden niet draagvermogen.
40. Gebruik het apparaat alleen op een vlak, egaal, hard en glad oppervlak dat een volledig gevulde Fabric Room Divide veilig kan dragen.
41. Alleen gebruiken zoals bedoeld.
42. Controleer het product voor elk gebruik. Gebruik het niet als er

onderdelen loszitten of beschadigd zijn.

**BEWAAR DEZE HANDLEIDING**

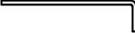
## PARTS LIST

A		6
B		6
C		6
D		6
Ik		6
F		2
G		1
H		3
I	 X18	Vooraf opnieuw geladen

**LET OP :** De accessoires F zijn reserveschroeven voor cadeaus; H is de stof van het scherm. Let op dat deze niet vies wordt tijdens de installatie.

## ASSEMBLY STEP

### STAP 1

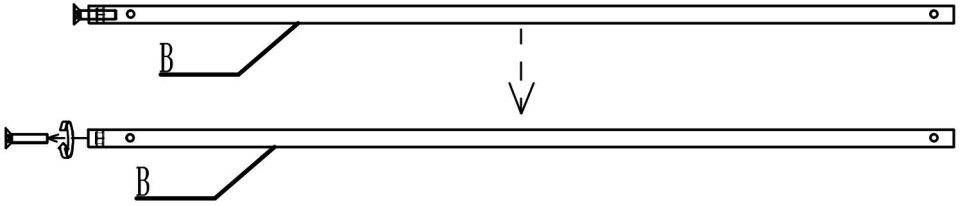

Unscrew from material B and set aside.

# X6

### STAP 2

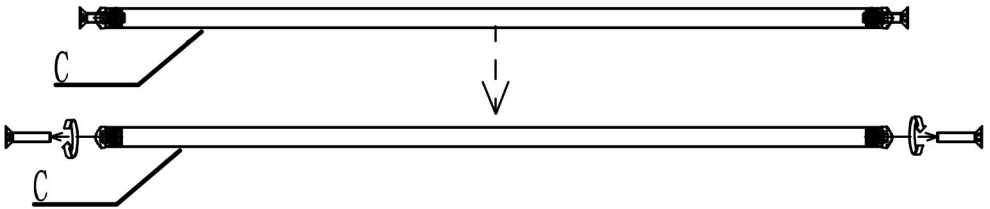

Unscrew from material C and set aside.

# X6

### STAP 3

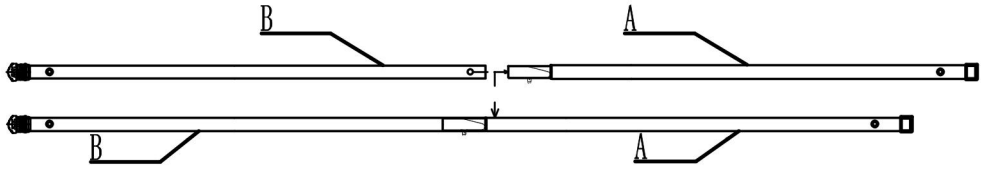

Connect material B and Material A (as shown in the figure) and put them together.

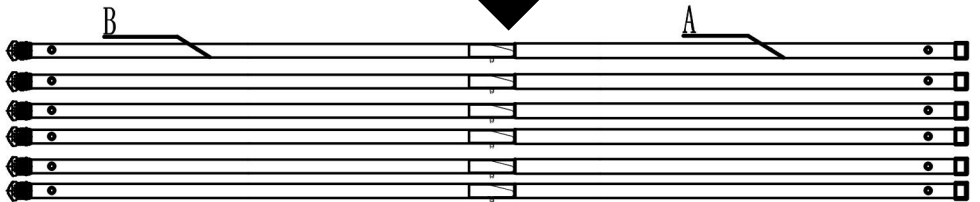

**Total 6 groups**

### STAP 4

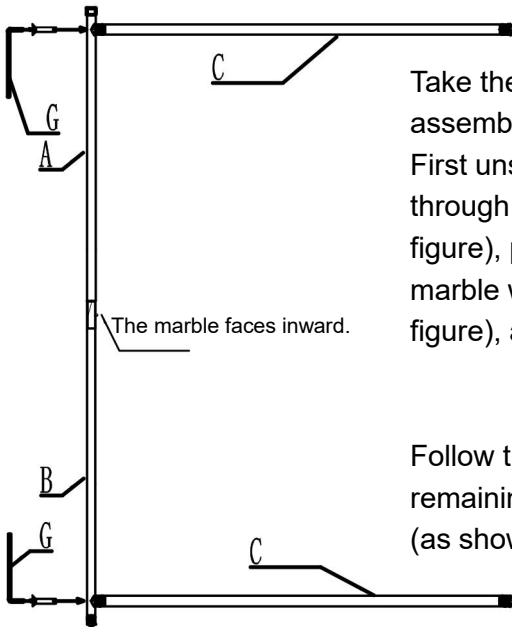

Take the two poles from Step 2 and assemble them on one pole from Step 3. First unscrew the screw, and then connect through the screw (as shown in the figure), pay attention to the position of the marble when combining (as shown in the figure), and then tighten with G tool.

Follow the same steps to connect the remaining 2 groups for a total of 3 groups (as shown)

## STAP 5



H Material is screen fabric, pay attention to keep clean during installation

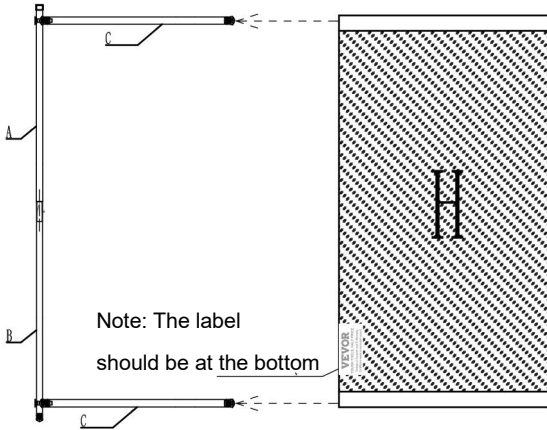

Insert the sleeve of material H into the upper and lower cross bars.

## STAP 6

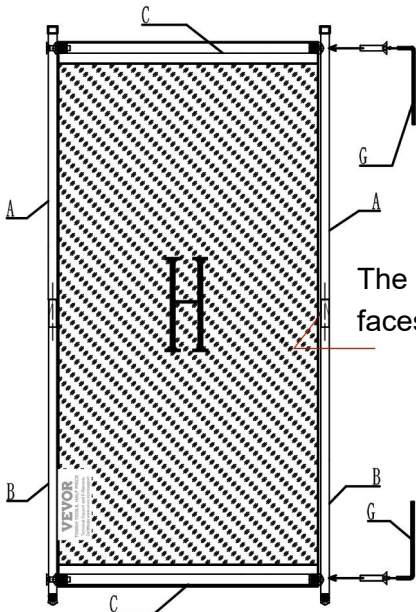

The marble faces inward.

From the remaining tubes in step 3, take a set of tubes, assemble them on the frame, unscrew the screws first, then connect them, and then tighten them with the G tool.

Do the same for the other two groups. Note the position of the marble.

## STAP 7

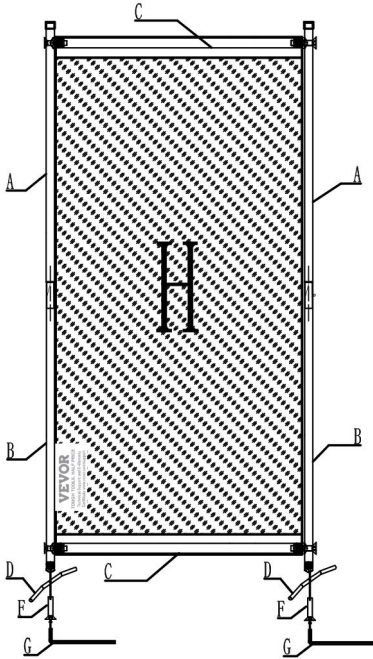

Take material D and assemble it in the frame of step 6. Unscrew the screw first, then connect it, and then tighten it with tool G.

The remaining 2 groups complete the assembly with the same steps.

## STAP 8

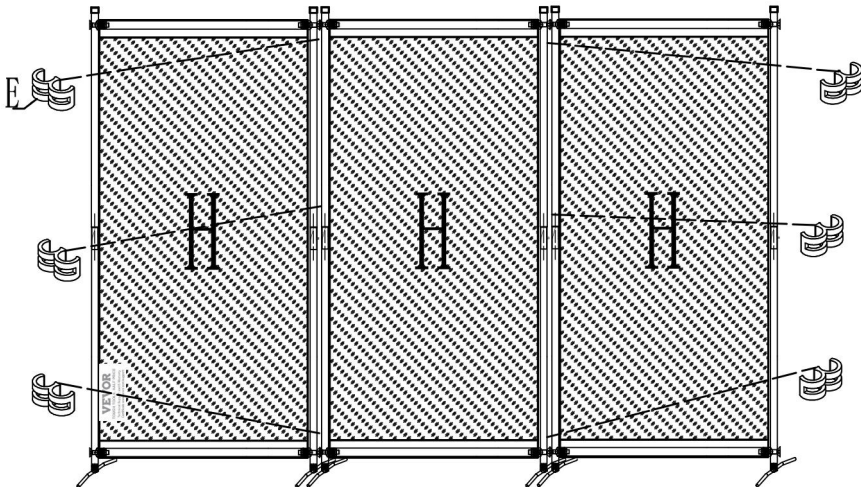

Put the 3 groups of shelves neatly and connect them by material B.

## STAP 9

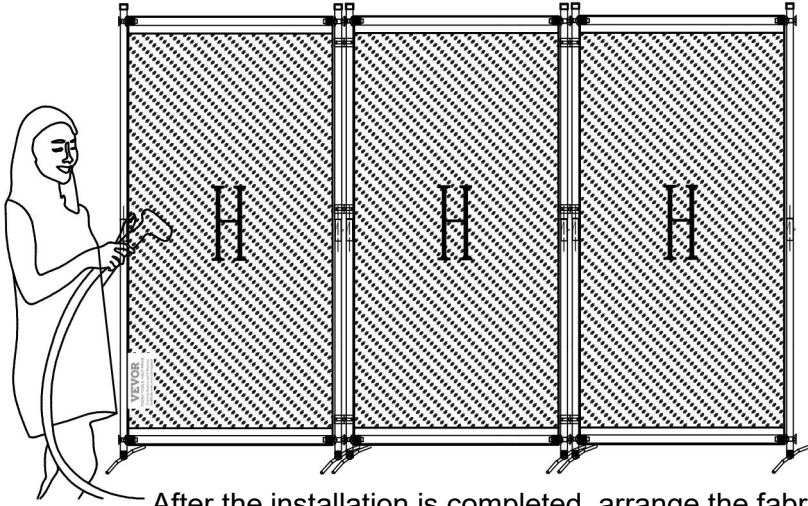

After the installation is completed, arrange the fabric to ensure that the fabric is smooth. If the fabric has wrinkles, you can use a household hanging press to iron it.

## STAP 10

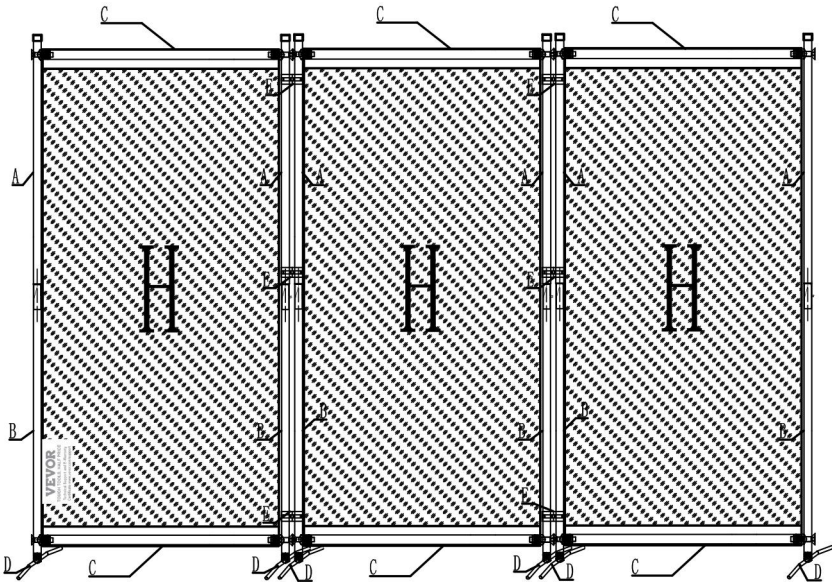

## PRODUCT PARAMETER

<b>Model</b>	<b>PFTSTGHS04</b>	<b>PFTSTGSH05</b>	<b>PFTSTGMS06</b>
<b>Kleur</b>	B gebrek	Grijs	Crèmekleurig
<b>Aantal panelen</b>	3		
<b>Productgrootte</b>	2600*1840*520mm		

**Fabrikant:** Shanghaimuxinmuyeyouxiangongsi

**Adres:** Shuangchenglu 803nong11hao1602A-1609shi, baoshanqu,  
Sjanghai 200000 CN.

**Geïmporteerd naar AUS:** SIHAO PTY LTD. 1 ROKEVA  
STREETEASTWOOD

NSW 2122 Australië

**Geïmporteerd naar de VS:** Sanven Technology Ltd. Suite 250, 9166  
Anaheim

Plaats, Rancho Cucamonga, CA 91730

<b>UK</b>	<b>REP</b>
-----------	------------

YH CONSULTING LIMITED. C/O YH Consulting  
Limited Office 147, Centurion House, London  
Road, Staines-upon-Thames, Surrey, TW18 4AX

<b>EC</b>	<b>REP</b>
-----------	------------

E-CrossStu GmbH  
Mainzer Landstr.69,  
60329 Frankfurt am Main.





# **TYG RUMSDELNING**

## **Användarmanual**

**PFTSTGHS04**

**PFTSTGSH05**

**PFTSTGMS06**

# FABRIC ROOM DIVIDE

PFTSTGHS04 PFTSTGSH05 PFTSTGMS06

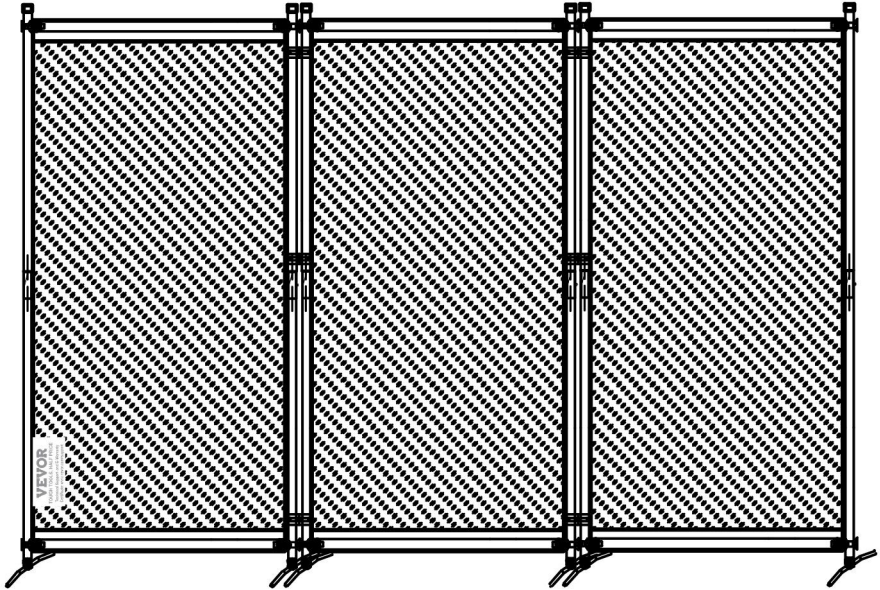

## SAFETY INSTRUCTIONS

### **WARNING:**

**Läs detta material innan du använder denna produkt. Underlåtenhet att göra det kan resultera i allvarliga skador.**

### **Försiktighetsåtgärder vid montering**









57. Montera endast enligt dessa instruktioner. Felaktig montering kan skapa faror.
58. Använd ANSI-godkända skyddsglasögon och kraftiga arbetshandskar vid montering.
59. Håll monteringsområdet rent och väl upplyst.
60. Håll åskådare borta från området under monteringen.
61. Sätt dig inte ihop om du är trött eller påverkad av alkohol, droger eller medicin.
62. Produktens egenskaper gäller endast för korrekt och färdigmonterade produkter.
63. Montera på en plan, jämn, hård och slät yta som säkert kan stödja tygrumsdelningen.
64. För ytterligare information om delarna som listas på följande sidor, se monteringsdiagrammet i denna manual. Packa upp och separera alla delar på ett rent arbetsområde.

### **Använd försiktighetsåtgärder**

43. SIT ELLER STÅ INTE PÅ DETTA FÖREMÅL.
44. Denna produkt är inte en leksak. Låt inte barn leka med eller nära detta föremål.
45. Överskrid inte specificerat viktkapacitet.
46. Använd endast på en plan, jämn, hård och slät yta som säkert kan bära upp en fulladdad rumsdelning av tyg.
47. Använd endast som avsett.
48. Inspektera före varje användning; Använd inte om delar är lösa eller skadade.

# SPARA DENNA MANUAL

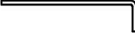
## PARTS LIST

A		6
B		6
C		6
D		6
E		6
F		2
G		1
H		3
jag	 X18	P laddas om

**OBS : F-tillbehör är reservskruvar för present; H är skärmens tyg, var uppmärksam på att inte bli smutsig vid installation.**

## ASSEMBLY STEP

### STEP 1

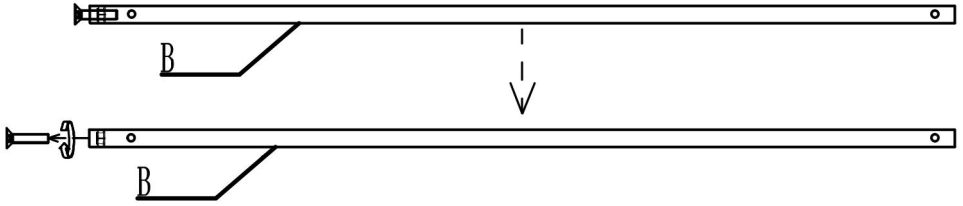

Unscrew from material B and set aside.

# X6

### STEP 2

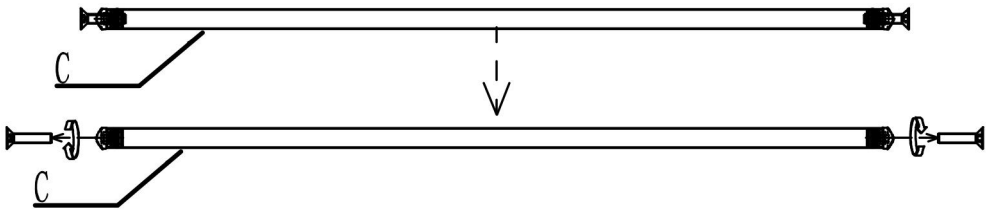

Unscrew from material C and set aside.

# X6

### STEP 3

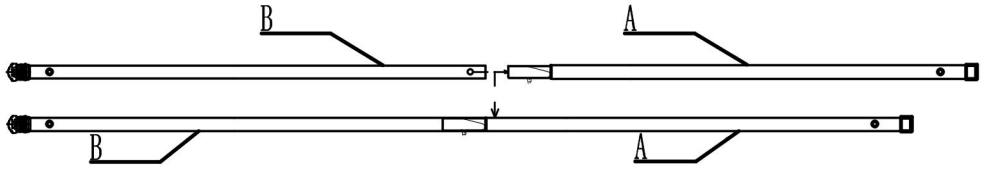

Connect material B and Material A (as shown in the figure) and put them together.

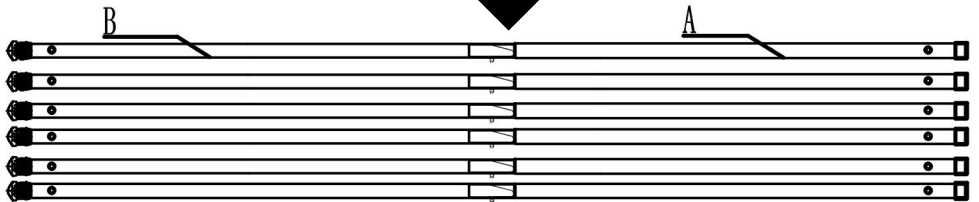

**Total 6 groups**

### STEP 4

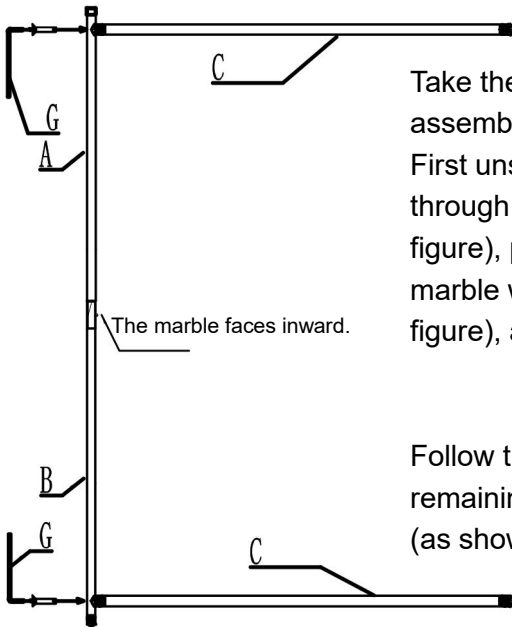

Take the two poles from Step 2 and assemble them on one pole from Step 3. First unscrew the screw, and then connect through the screw (as shown in the figure), pay attention to the position of the marble when combining (as shown in the figure), and then tighten with G tool.

Follow the same steps to connect the remaining 2 groups for a total of 3 groups (as shown)

## STEP 5



H Material is screen fabric, pay attention to keep clean during installation

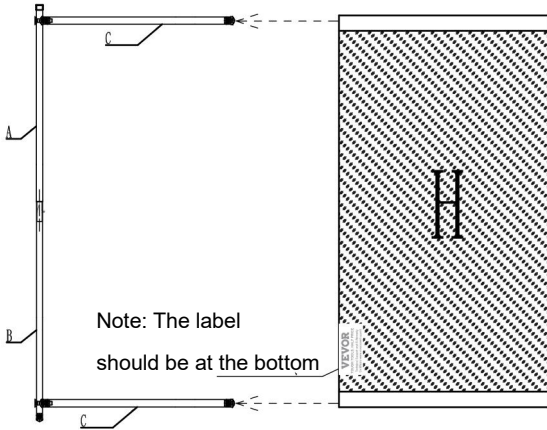

Insert the sleeve of material H into the upper and lower cross bars.

## STEP 6

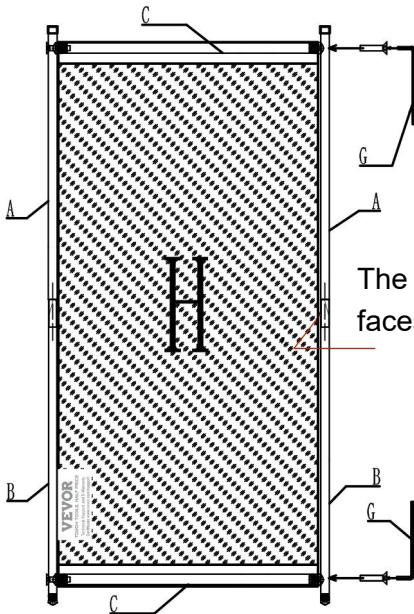

From the remaining tubes in step 3, take a set of tubes, assemble them on the frame, unscrew the screws first, then connect them, and then tighten them with the G tool.

Do the same for the other two groups. Note the position of the marble.

## STEP 7

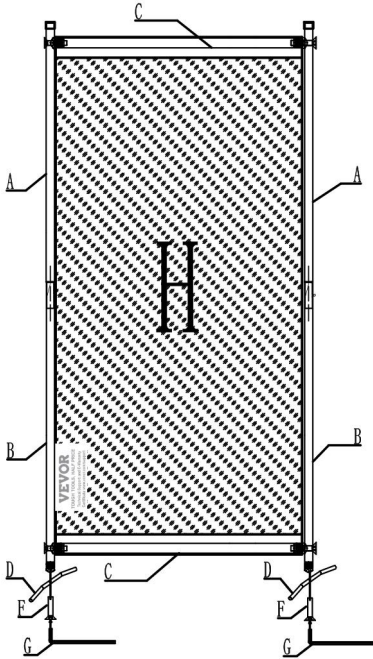

Take material D and assemble it in the frame of step 6. Unscrew the screw first, then connect it, and then tighten it with tool G.

The remaining 2 groups complete the assembly with the same steps.

## STEP 8

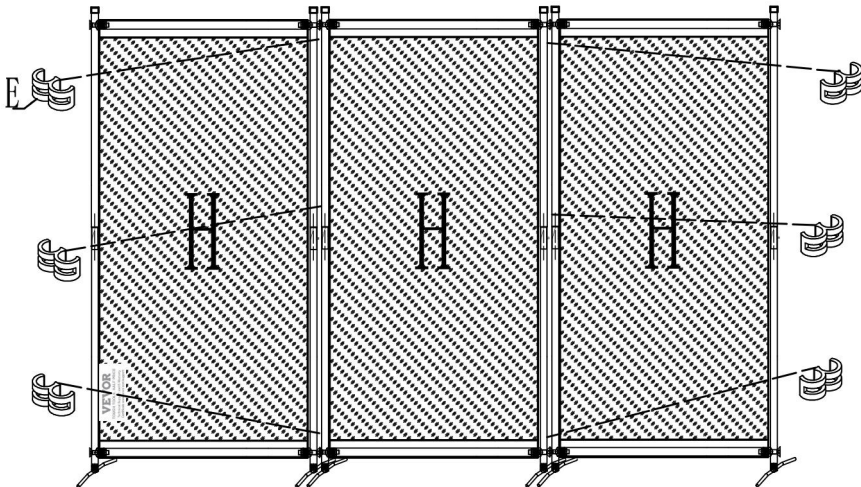

Put the 3 groups of shelves neatly and connect them by material B.

## STEP 9

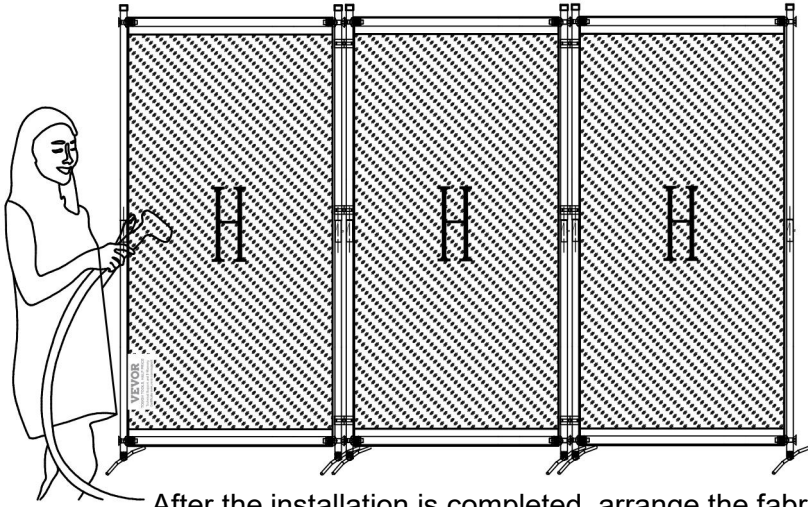

After the installation is completed, arrange the fabric to ensure that the fabric is smooth. If the fabric has wrinkles, you can use a household hanging press to iron it.

## STEP 10

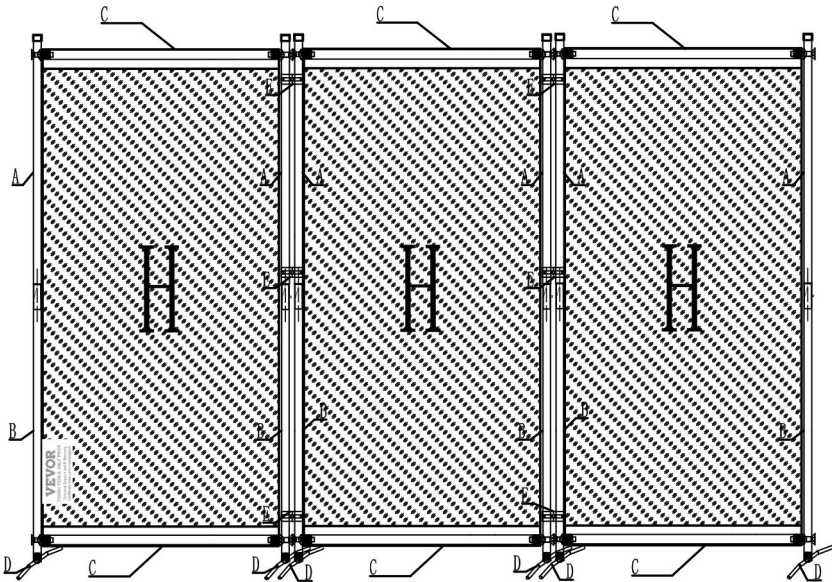

## PRODUCT PARAMETER

<b>Modell</b>	<b>PFTSTGHS04</b>	<b>PFTSTGSH05</b>	<b>PFTSTGMS06</b>
<b>Färg</b>	B brist	G ray	C ream- Färgad
<b>Antal paneler</b>	3		
<b>Produktstorlek</b>	2600*1840*520mm		

**Tillverkare:** Shanghaimuxinmuyeyouxiangongsi

**Address:** Shuangchenglu 803nong11hao1602A-1609shi, baoshanqu, shanghai 200 000 CN.

**Importerad till AUS:** SIHAO PTY LTD. 1 ROKEVA STREETEASTWOOD NSW 2122 Australien

**Importerad till USA:** Sanven Technology Ltd. Suite 250, 9166 Anaheim Place, Rancho Cucamonga, CA 91730

<b>UK</b>	<b>REP</b>
-----------	------------

YH CONSULTING LIMITED. C/O YH Consulting Limited Office 147, Centurion House, London Road, Staines-upon-Thames, Surrey, TW18 4AX

<b>EC</b>	<b>REP</b>
-----------	------------

E-CrossStu GmbH  
Mainzer Landstr.69,  
60329 Frankfurt am Main.



